

12dModel

Getting Started for Surveying

Version 9.0

May 2009

12D SOLUTIONS PTY LTD

ACN 101 351 991

PO Box 351 Narrabeen NSW Australia 2101

Australia Telephone (02) 9970 7117 Fax (02) 9970 7118

International Telephone 61 2 9970 7117 Fax 61 2 9970 7118

email support@12d.com web page www.12d.com



12d Model 9 Getting Started for Surveying Manual

7	first released in January 2005
8	first released in February 2007
9	first released in May 2009

Disclaimer

12d Model is supplied without any express or implied warranties whatsoever.

No warranty of fitness for a particular purpose is offered.

No liabilities in respect of engineering details and quantities produced by 12d Model are accepted.

While every effort has been taken to ensure that the advice given in this manual and the program 12d Model is correct, no warranty is expressed or implied by 12d Solutions Pty Ltd.

Copyright

This manual is copyrighted and all rights reserved.

This manual may not, in whole or part, be copied or reproduced without the prior consent in writing from 12d Solutions Pty Ltd.

Copies of 12d Model software must not be released to any party, or used for bureau applications without the written permission of 12d Solutions Pty Ltd.

Copyright (c) 1989-2009 by 12d Solutions Pty Ltd.
Sydney, New South Wales, Australia.
ACN 101 351 991
All rights reserved.



Table of Contents

Preface	9
Why a 'Getting Started for Surveying' Manual ?	9
Training Material	9
Getting Started for Design	9
Using the Practise and Small Versions of 12d Model.....	9
1 Installing 12d Model.....	11
2 Before You Begin the Training	13
Installing the Training Files	13
12d Icons on your Desktop	13
Using the Practise Version	13
Overview of 12d File and Folder Structures	13
Why Keep Projects in Separate	14
File Backup Procedures.....	14
3 Basic Operations.....	17
The 'Mouse'	17
Starting Up - The Project Selection panel.....	18
The Initial Screen Layout.....	20
How to Find Your Way Around 12d Menus.....	22
Toolbars and Controlbars	26
CAD Toolbar and CAD Controlbar	26
CAD Text Toolbar and Text Controlbar.....	29
Symbol Controlbar.....	31
.....	31
Search Toolbar	32
.....	32
.....	32
Snaps Toolbar	33
Status Bar	33
Screen Message Box	33
View Coordinates Box	34
The Output Window.....	34
Basic View Operations.....	36
Introduction to Models	36
Introduction to Strings.....	37
Introduction to Panels	37
4 12d Model Help.....	39
Contents.....	39
Index.....	41
Find	42
Panel Help Button	43
F1 Key	44
Navigating in Help	44
5 Starting the Tutorial.....	45
Importing Point Data into 12d.....	45
Plan View Operations	52
Birds-Eye Views and 'Throwing' Between Views	54
Deleting a Model.....	56
Redraw - Fixing up a Modified or Erroneous View	57
Work Book Mode.....	57
Saving a Project.....	58
Exit	58
Restarting 12d with an Existing Project.....	58
6 Basic Modelling.....	59
Alternative data entry	59
Saving model listing to a file for future use	60
Triangulation	61

Tin inquire.....	64
'Fast' Contours	66
'Fast' Flow Arrows.....	68
Perspective View	69
Joy Panel	71
Orbit Panel	72
'Fast' Meshes in Perspective view.....	73
Contours in Perspective Views	75
Shaded Views	76
7 String Picking Concepts	77
String Inquire	78
Use of Mouse Buttons and Enter Key when using Tentative Picking.....	80
Pick Operations Menu via the Right Mouse Button.....	80
Snap Settings.....	81
Models and Snap Settings.....	83
Fast Picking.....	83
Modifying the String Highlighting Colour	84
8 Creating Strings with CAD	87
Creating Points.....	87
Creating Two Point Lines	91
Creating Line Strings.....	92
9 Survey Data Reduction	95
Coding.....	95
Feature Codes	95
Field Codes	95
String numbers.....	96
Delimiters	97
Setting up a New Project	98
Screen Setup	102
Project description	103
Survey Station Coordinate entry.....	104
Data collection reduction	106
Creating/Checking/Modifying a 12d Data Collector Definition	107
Selecting the Data Recorder type	109
Downloading a Raw Survey File from an Instrument.....	110
Converting a Raw File to a 12d Field File	111
Running the Survey Data Reduction Function.....	112
Checking the Report File for Reduction Errors.....	117
Editing the Map File.....	119
Re-Running the Survey Data Reduction Function	125
Graphically Editing the Field File Data.....	126
View the Survey Data.....	126
Setup your text screen settings	128
Graphically Editing the Field File Data.....	130
Direct Editing of the Field File	139
To Find data in the Field File	140
Printing the Report File.....	146
Locking the Data Reduction Function.....	147
Graphical Edits	148
Joining strings.....	149
Reverse String	153
Add arc to curve	154
Triangulation.....	155
Check for Crossing Breaklines	155
Delete empty models	157
Triangulate data	157
Nulling Triangles.....	159

Tin Boundary	164
Viewing fast contours	166
Perspective Views	168
Section views	170
Plotting	172
Create New Plan View	172
Feature labelling	173
Setting the correct plot scale for the view	176
Creating Contours	177
North Point	180
Text Editing	181
Grid display	186
Quick sheet plot	187
Plotting Using Plot Frame	189
10 Volumes	197
Stockpile volume	197
Existing surface	199
Stockpile surface	203
Check stockpile tin lies within existing tin	204
Calculate volumes by exact method	205
Calculate volumes by End area	206
Multiple stockpiles	210
Read in Stockpile surface data	210
Run Stockpile macro	211
Dam Capacity	215
Read in Dam surface data	215
Calculate volumes by Storage Calcs method	217
Surface Comparison	219
Read in Surfaces	219
Check Stripped tin lies within existing tin	224
Calculate volumes by exact method	225
Create depth shading	226
Create tabulation of range file	228
Progressive volumes	229
Read in multiple surveys	229
Check April and May tin lies within March tin	236
Calculate volumes from March to April survey	239
Combine the March and April surfaces	242
Calculate volumes from April to May survey	248
Combine the April combined surface and May surfaces	251
11 Setout	257
Building setout	257
Create the lot outline	259
Create building outline	262
Create dimensioned offset lines from house corners to boundaries	269
Create dimensions for lot and building lines	271
Setout points	274
Create upload file	276
Uploading file to data collector	277
Importing house file	279
Share the lot outline from the previous project	280
Read in the CAD file	282
Scale the house models	283
Rotate the building	284
Translate the house	285
Create outline of house for setout	287
Setout for evenly graded string	288

Read in the polyline from cad	288
Convert the polyline to a super alignment string.....	289
Create heights for each end of the alignment	292
Create special chainage file for setout points	293
Create setout points	294
Setout for polyline culdesac string.....	296
Read in the polyline from cad	297
Filter the imported string to ensure there are no duplicate vertices at the tangent points.....	298
Segment the string	300
Add heights to string	301
Parallel the lip string for setout	302
Triangulation setout	304
Import file.....	304
Create upload file of the triangles	305
Road Setout.....	307
Create upload file of road alignment for Leica 1200	307
Create upload file of road alignment for Trimble	308
Setout reports	310
Read in Ascon survey	310
Calculate the differences between the design and as constructed data	311
Check asbuilt strings against design strings	312
Check as constructed points against the design tin	314
12 Subdivision Design	317
Setting up a New Project	318
Create the surrounding boundary.....	319
Duplicate the surround.....	321
Open the Boundary string	322
Create Road Centreline	322
Create Road boundaries	325
Parallel centreline string	325
Convert arcs to chords	327
Splay the road intersection boundaries	330
Create Cul de sac head	334
Create lots	340
Split string at starting edge	340
Create lots by different methods.....	341
Lot numbering.....	357
Create lot numbers.....	358
Lot labelling.....	360
Edit the annotation.....	363
Create Short Line table.....	364
Create colour table of lot areas	366
Lot Reporting	368

Preface

Why a 'Getting Started for Surveying' Manual ?

12d Model is supplied with a comprehensive on-line Reference manual which describes the function of each menu option in detail. It is a Reference manual however and makes no attempt to describe how to use *12d* for production surveying and civil engineering work.

This *Getting Started for Surveying* manual is designed to show you how to install *12d Model*, work with the on-line help system, and then as the first section of Training, help you start to learn how to use *12d* to achieve typical surveying tasks. The *Getting Started for Surveying* manual uses examples where possible to clarify usage. It complements rather than replaces the on-line Reference manual. In general, information in the on-line Reference manual will not be duplicated here.

The *Getting Started for Surveying* manual is available as a printed manual and as a PDF file on the *12d Model Training DVD*.

Training Material

The training tutorials assumes that a series of files are already on your hard disk. These tutorial files are automatically installed from the DVD during installation of the *12d Model* software.

Getting Started for Design

There is also a *Getting Started for Design* manual which has the first seven chapters in common with the *Getting Started for Surveying* manual (on-line help and basic modelling) but then diverts to cover topics from the direction of a civil designer whereas the *Getting Started for Surveying* manual continues on with surveying techniques.

The *Getting Started for Design* manual is available as a printed manual and as a PDF file on the *12d Model Training DVD*.

Using the Practise and Small Versions of 12d Model

The Practise version of *12d Model* is limited to a maximum of 5,000 points. Following the procedures as stated in the Training Manual may create projects with more than 5,000 points.

Where appropriate, the text will suggest how to vary the input for each instruction so that the example feature can be completed within the limits of the *12d Model Practise* version.

The number of points used at any time in the Practise and small versions can be displayed by the option

Projects => Check base points

The easiest way to reduce the current point count is to delete any unwanted models with

Models => Delete

The installed icon on your desktop for running the practise version of *12d* with these training files is labelled *12d 8 Practise*.

Please Note: Projects created by Practise versions of *12d Model* cannot be accessed by Release versions of *12d Model* and vice-versa.



1 Installing 12d Model

The *12d Model 9 Installation DVD* can be used to install the *Release* and *Practise* versions of **12d Model 9**.

The *Practise* version is limited to a maximum of 5,000 points and creates projects that cannot be accessed by the *Release* versions of *12d Model* and vice-versa. However the *Practise* version can be used free of charge by *12d Solutions* customers and registered *Practise* Users.

Installing the Release Version for Sites Not Running 12d Model 8 or 12d Model 9

For a **new** installation of the **Release** version of *12d Model 9*, the user is provided with

- (a) one *12d Model* dongle
- (b) one *12d Model 9 Installation DVD*
- (c) an email with the *12d Model 9* authorization file *nodes.12d9n* attached, or a folder with the *12d Model 9* authorization file *nodes.12d9n* or *nodes.4d* in it.

Please check that you have all three items before commencing the installation.

The **notes** and **video** for a new install of the *Release* version of *12d Model 9* are on the **12d Model 9 Installation DVD** or can be downloaded from the *12d* web site www.12d.com under the *Updates* area.

Installing the Release Version for Sites Already Running 12d Model 8 or 12d Model 9

Existing *12d Model 8* or *12d Model 9* users already have a dongle and so are only provided with

- (a) one *12d Model 9 Installation DVD*
- (b) an email with the *12d Model 9* authorization file *nodes.12d9n* attached, or a folder with the *12d Model 9* authorization file *nodes.12d9n* or *nodes.4d* in it.

For existing *12d Model 8* users, your existing dongle can be used with *12d Model 9*. If *12d Model 9* is **already** running on your computer, please **uninstall** it before installing a new version of *12d Model 9*.

The **notes** and **video** for a new install of the *Release* version of *12d Model 9* are on the **12d Model 9 Installation DVD** or can be downloaded from the *12d* web site www.12d.com under the *Updates* area.

Installing the Practise Version:

To install a **Practise** version of *12d Model 9*, all that is needed is:

one *12d Model 9 Installation DVD*

or *12d Model 9 Practise* downloaded from www.12d.com

The *Practise* version must be Registered with *12D Solutions* once it is installed on a computer. A new Registration is required for each computer that the *Practise* version is run on.

The **notes** and **video** for installing the *practise* version of *12d Model 9* are on the *12d Model 9 Installation DVD* or can be downloaded from the *12d* web site www.12d.com under the *12d Model 9 Practise* area.



2 Before You Begin the Training

2.1 Installing the Training Files

If you have installed Training from the *12d Model Installation DVD*, then the *Training* folder will have been automatically created for you but where the files reside on the disk depends on whether you installed the *Release* version or the *Practise* version of 12d Model.

The Training manual dialogue assumes that the working folder (i.e. shortcut) of your **12d Model 9** or **12d Model 9 Practise** icon is set to

c:\12d\9.00 for the *Release* version of 12d Model

and

c:\12 Model 9 Practise for the *Practise* version of 12d Model

The training files can be placed in any sub-folder on your hard disk but for convenience in this manual, it is assumed that the training files are installed in

c:\12d\9.00\Training

All the required material is already in the *Training* folder.

2.2 12d Icons on your Desktop

It is recommended that you use the **12d Model 9** icon for the *Release* version or **12d Model 9 Practise** icon for the *Practise* version whilst initially working with this training manual. The reason for this is that the icon points directly to the folder that contains the *Training* folder.

2.3 Using the Practise Version

Remember that the *Practise* version of 12d Model is limited to a maximum of 5,000 points.

Following the procedures as stated in the Training Manual may create projects with more than 5,000 points. Where appropriate, the text will suggest how to vary the input for each instruction so that the example feature can be completed within the limits of the *12d Model Practise* version.

2.4 Overview of 12d File and Folder Structures

Before you begin using 12d, it is useful to understand how 12d uses the file and folder structure under Windows 2000, XP and Vista.

12d recognises long filenames up to 256 characters so you are not limited to the old DOS convention of 8.3 filenames.

The 12d software and its support files are installed on your hard disk, the program itself is installed into the folder c:\Program Files\12d and various subfolders below. The training data and user areas, are installed into the folder c:\12d9.00 and subfolders below.

When the software was installed, the **12d Model 9** program icon is setup to point to the folder c:\12d\9.00.

The tutorial is about designing a road and the training files have been set up in a folder c:\12d\9.00\Training\9.00\Design\Getting Started Basic.

As each 12d Model project you work on will have different files, it is strongly recommended that you keep each project in a separate subfolder. This can be anywhere on your hard disk or network. For convenience, you may prefer to keep them all under one major folder e.g. c:\12djobs.

In the general case for production work however, if you were about to start work on a new project by the name 'Highway', you would like it to be in a new folder under say 12djobs i.e. c:\12djobs\Highway. This is simply done from within 12d Model where a folder of the same name as the project is automatically created with the project inside it.

Either numeric or alpha characters and spaces can be used in 12d Model project names so you may prefer

to use your job name as the project name. Also 12d project names are *not* case sensitive so 'Highway' is seen as the same name as 'highway'.

2.5 Why Keep Projects in Separate

12d can have more than one project within the one Windows folder. For example, projects under 'Highway' might be 'Stage 1' and 'Stage 2' or 'Fred' and 'Bill'. Each project has its own data and configuration setup which controls the number of views, which models are on display etc.

However although most internal 12d project files are kept separate another projects internal files, all *input* and *output* files, *mtf* files, *chains*, *plots* and *reports* go into the folder containing the project and are not held inside the project itself. Hence to prevent projects interfering with each other, it is best to create a separate folder and create each project in its own folder.

For example, if the Highway project has two stages, create the project *Stage 1* in the folder *Highway\Stage 1* and the project *Stage 2* in the folder *Highway\Stage 2*

Once inside 12d, from within any one project, it is possible to import any or all data from another project so there is some flexibility on a major job to move/copy survey or design data between stages if staging is used and then have multiple users perform parallel development. Model and tin sharing could later be used to subsequently assemble staged project data at the completion of a major job. Within any one project, model names must be unique so some planning is necessary if parallel development streams are subsequently to be reassembled. Models can be renamed at any time. Models are discussed in See Chapter 3.11 (on page 36).

Provided no 12d user is currently accessing a particular project, the project (and the folder containing it) can be copied, renamed, moved and deleted from within 12d.

WARNING - information inside the project itself *should not* be manipulated except from within *12d Model* since this may corrupt the project and data could be lost. For example, model names can only be renamed from within 12d Model.

If you need to manually place any files on disk for a project (e.g. survey files from a total station or CAD files to get data into 12d), it is recommended that you place them in the folder containing the project. that way all the data and the project are in the one folder.

2.6 File Backup Procedures

To ensure that you can retrieve any job or project at any time from backup procedures, it is important that a complete 'set' of files is taken whenever backup is created. To backup the files associated with the 'Highway', you would typically backup all files and sub-folders in and below

c:\12djobs\Highway

There are configuration files used that may be used in the Highway job, that are supplied by 12D Solutions and are automatically installed from the 12d Model Installation DVD. These files are in

c:\Program Files\12d\12dmodel\9.00\set_ups

c:\Program Files\12d\12dmodel\9.00\library

There are other user configurable files that 12d may use and require to fully recreate all steps of a project. They are not supplied on the 12d Model Installation DVD. These files are typically in

c:\12d\9.00\user

c:\12d\9.00\user_lib

These folders may contain files that have been configured specifically for your site e.g. your corporate standard mapping, template and plot parameter files, your particular Total Station survey macros and any user defined macros etc. In general, such files are not project specific, however because these files are user configurable they may be changed at any time and hence particular project specific versions of them may be needed as part of the complete file set of a project.

In the above case, the folders shown are for 12d Model 9. As implied, the files in these folders will never

be changed automatically by the installation process when you reinstall a later version of 12d.

The above paths are indicative only. It is possible that folders have been setup at different places for your site. For more information on exactly where all library and user folders are located, refer to the following environment variables in Appendix A of the on-line Reference manual.

USER_4D
USER_LIB_4D
SET_UPS_4D
LIB_4D



3 Basic Operations

3.1 The 'Mouse'

12d works best with a three button mouse (preferable a wheel mouse). 12d will work with a (Microsoft) two button mouse but the lack of the middle button means that you have extra mouse clicks to perform.

All 12d Documentation uses the following notation for mouse functions.

LB = left mouse button	- used for picking screen items, menus etc.
MB = middle mouse button	- used to accept the highlighted item
RB = right mouse button	- used to pop up a list of alternatives



The left button is the 'Select' button – typically used to select graphic items or text. The middle button (or wheel) is the 'Accept' button, used to confirm a selection. The right button is the 'Menu' button. It is context sensitive and often displays a list of alternatives available at that instant.

With a two button mouse you achieve this functionality by clicking the right mouse button to pop up the 'Pick Operations' menu and then clicking LB on **Accept** or by simply pressing the <Enter> key

The term 'clicking' a button means pressing it down and releasing it again. The position of the mouse is taken at the time the button is released. In this tutorial manual, items that are selected by a mouse click are in **bold**.

As we get more experienced, we will also introduce the term 'dragging' the mouse for some advanced 12d operations. We do this by pressing down a button and whilst still holding it down, moving the mouse so that the screen cursor moves. Once a definite distance has been achieved, just a millimetre or two is sufficient, release the button. 12d notes the vector you defined and can use this information to detect the direction in which you dragged the mouse.

Finally, we will use the term 'double clicking'. This is where we press the button twice in quick succession. This is often used for short-cuts.

3.2 Starting Up - The Project Selection panel

If you installed *12d Model* from the *12d Model Installation DVD*, then a *12d Model 9.0* icon will have been created on your desktop. Double clicking on this icon will take you directly into the 12d\9.00 folder.

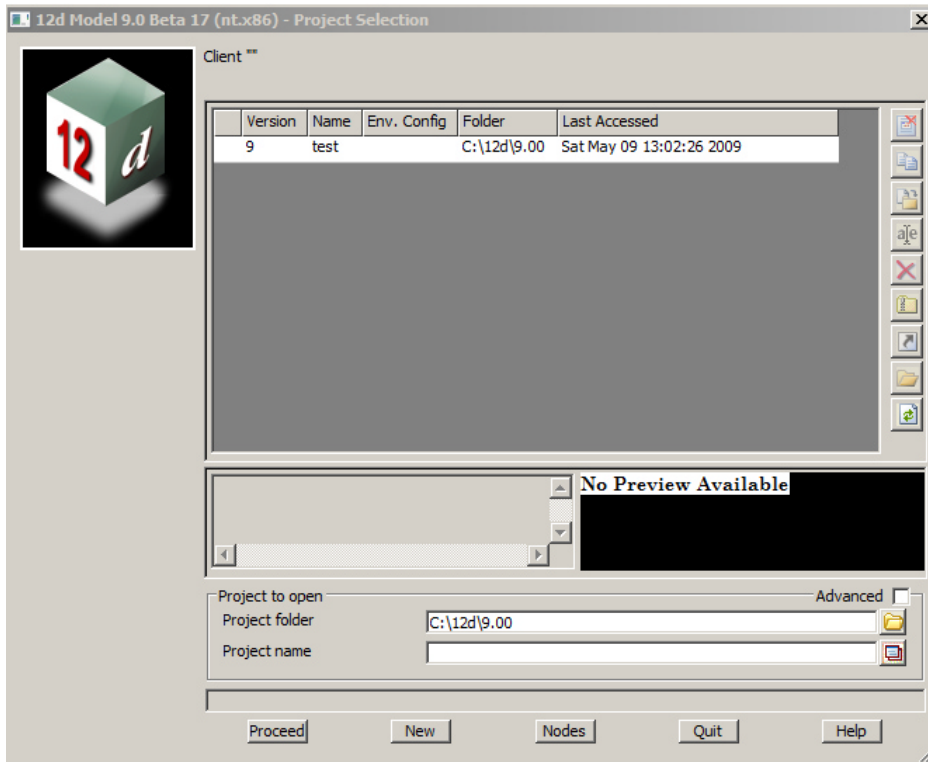

Once you are inside 12d, the Project Selection panel will appear.

To create a new project click the LB on *New* button at the bottom of the panel.

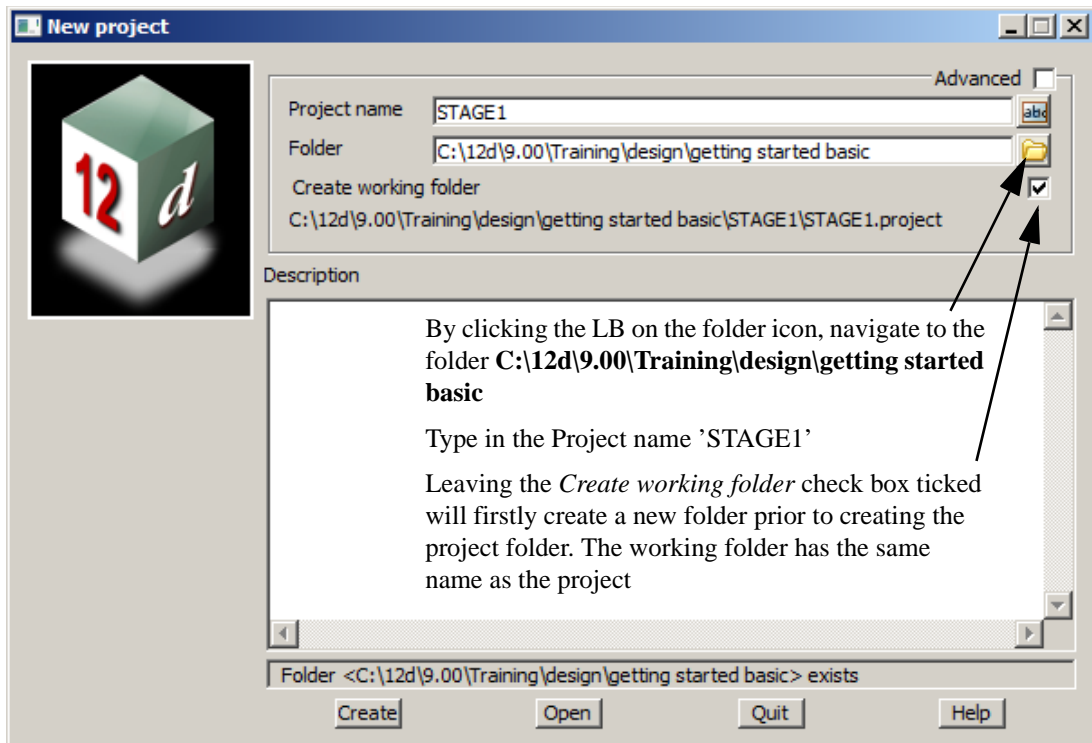

Click LB on *Create* button to create the project.

Notes:

1. It is important to select names that are meaningful to your job as you may have several projects associated with a large or complex job.
2. You only need to create a new project once. To access this project in subsequent 12d sessions, double click the LB on the project name from the pop up list. 12d will normally pop up the list automatically. If needed, you can use the button to open the list manually.

RULES FOR ENTERING DATA INTO PANELS

Important: The cursor must be locked into the appropriate data entry field when typing data into a 12d panel. Often this will happen automatically. If you cannot see the cursor flashing in the data field in which you want to enter data, use the mouse to position the cursor anywhere over the data field and click the LB to lock the cursor into the field before typing any data. Terminate the data entry sequence by pressing the Enter key.

If you make a mistake, you can always select the erroneous entry by double clicking over it with the mouse LB. The text should then appear highlighted. As you retype it, the old entry is deleted.

When filling in data in any 12d panel, it is not essential to terminate the entry of data by pressing the 'Enter' key. You can use the 'Tab' and 'BackTab' keys to move from field to field. You can also use the mouse to jump between fields. If you do press the Enter key to terminate the entry of data into a field, 12d will immediately validate the data in that field and supply an error message if appropriate

. Once a project is selected, the graphics screen will display, with the Project Details panel open. Fill in the panel with the relevant required details

Note that you must use the LB to click between fields and cannot use the 'Enter' or 'Tab' keys

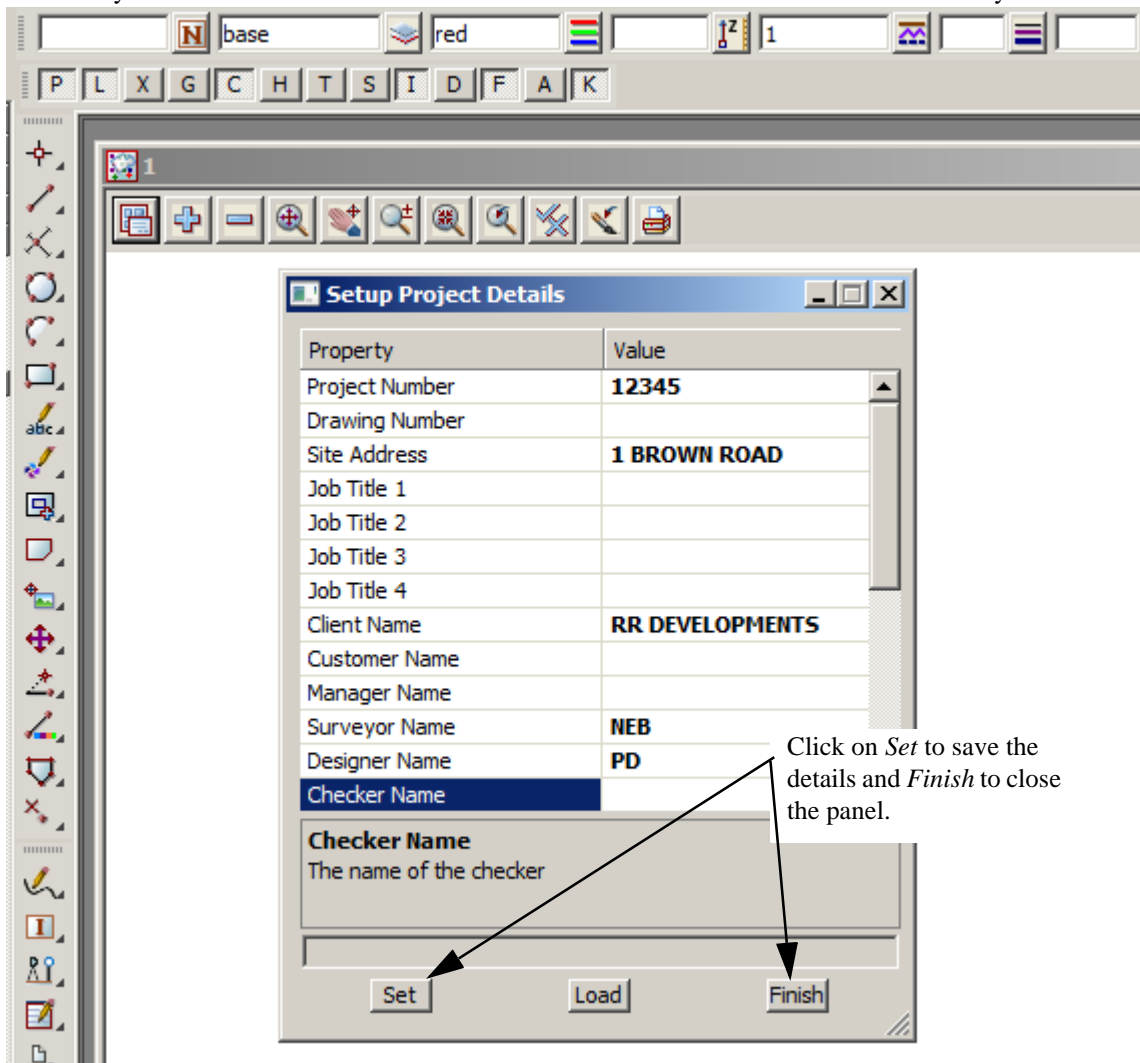

3.3 The Initial Screen Layout

The default background colour for a view is black. Black is the best colour for reducing eye strain, and for distinguishing colours displayed in the view. The names we use for the various parts of the screen are shown on the diagram below. Your screen may not appear exactly as shown as most components on the screen can be moved or turned off by user configuration options.

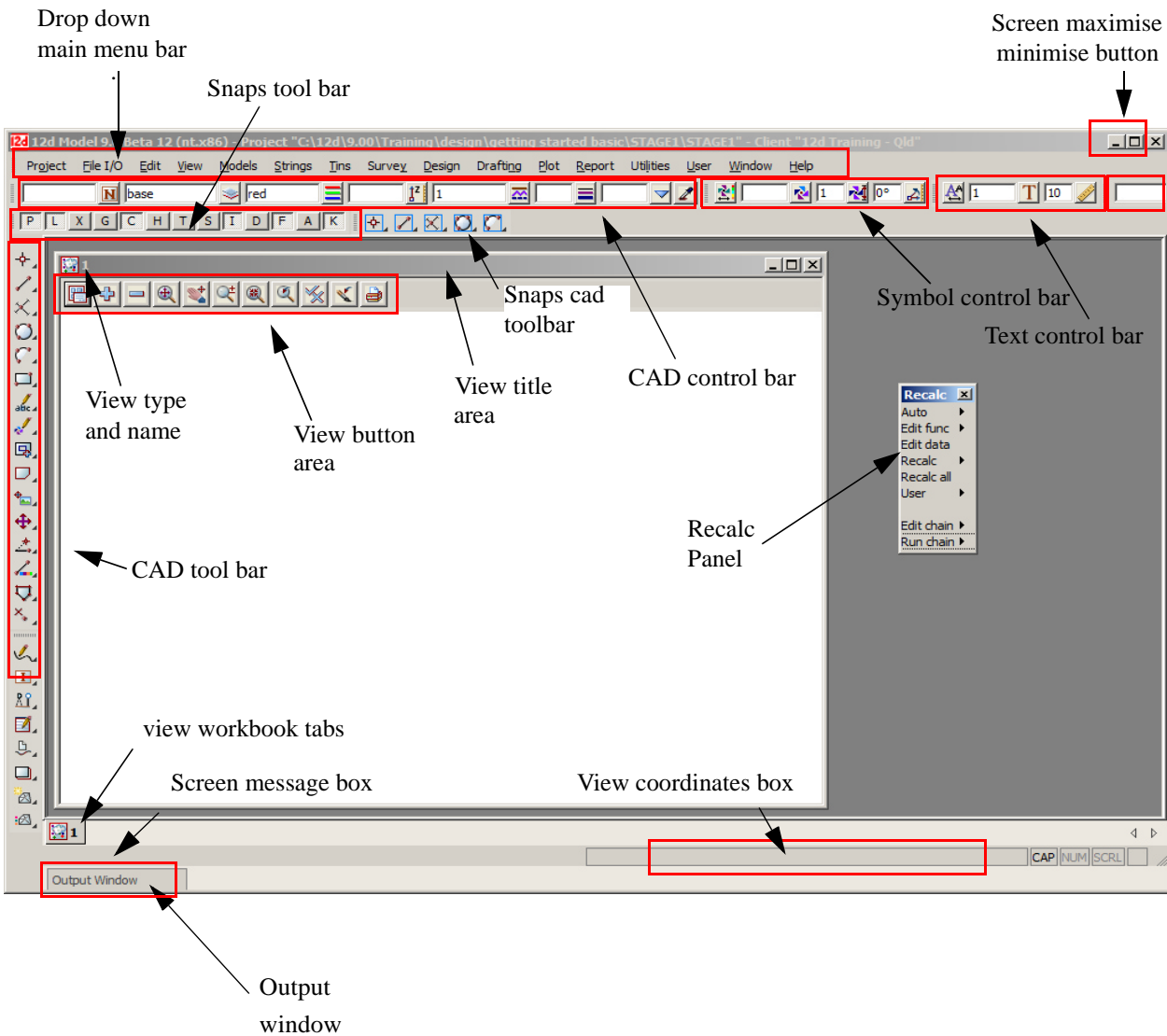

To make the *Getting Started* manuals easier to print on in-house printers, all of our illustrations have a white background colour.

Note that the View with the white background is headed 'Plan 1'. Each View in 12d is assigned to a Window. Like all Windows, they can be Minimised, Maximised or Closed.

The 'Plan 1' View can be maximised by clicking LB on the square button in the top right hand corner of the view menu.

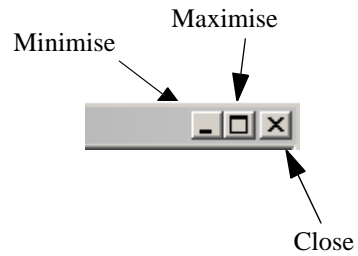

This then takes up the entire viewing area. Alternatively, you can double click LB on the plan view title area to maximise the view (The blue area to the left of the Minimise button). To reduce it back to its original size you can hit the restore icon.

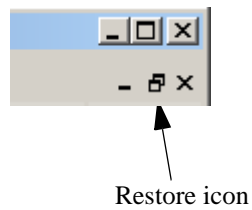

The 'Recalc' panel is used to quickly rerun design calculations and will be discussed later. We will move the panel down to the bottom left of the screen.

The view should then look as shown below.

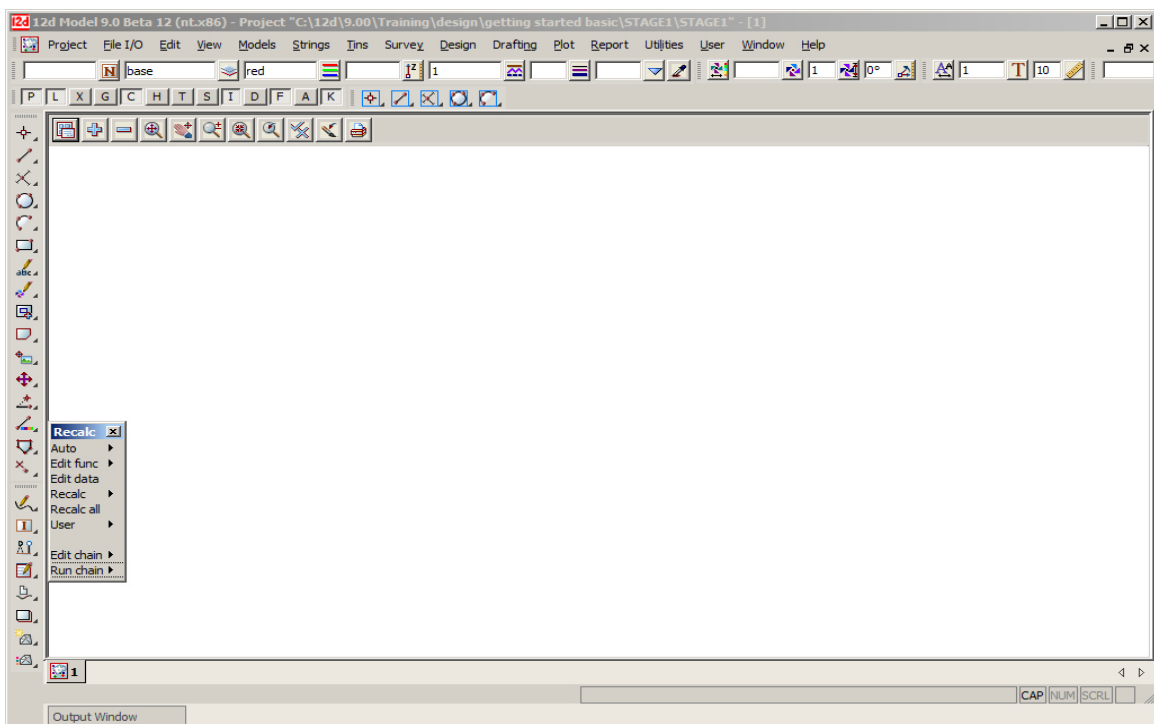

3.4 How to Find Your Way Around 12d Menus

12d options are run by a number of methods. The ‘Drop Down’ menu system from the bar running across the top of the screen is the main way we access 12d programs.

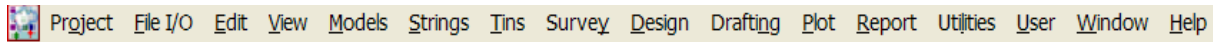

In addition to the ‘Drop Down’ Main menu system, there is a ‘12d Model’ menu which is maintained for compatibility reasons with earlier versions of the software. This is found at **Projects=>12d Model menu**.

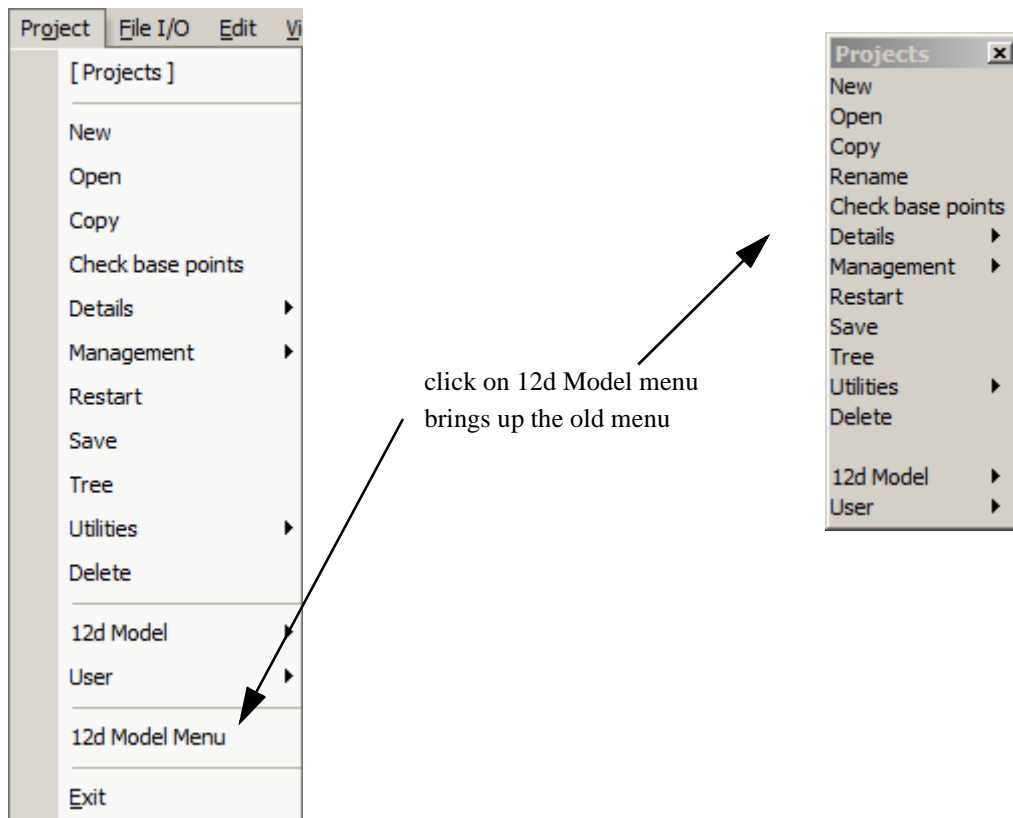

12d has a unique graphical user interface (GUI) involving hundreds of menu items. These are logically grouped by function in a ‘Walk Right’ and ‘Tear Off’ menu system. ‘Walk Right’ menus are menus designed such that if you move the mouse cursor right on a menu item containing a right arrow, a further menu will pop up, usually on the right hand side. ‘Tear Off’ menus means that a menu can be torn off it’s parent menu and relocated elsewhere on the screen for clarity of operation. In general, it is possible to have multiple copies of the same ‘Tear Off’ menu on the screen at one time.

Notice that the order of items left-to-right on the ‘Drop Down’ Main menu bar is the same as the top-to-bottom order on the ‘Walk Right’ 12d Model menu. You can select menu items from either one of these sources – the end result is the same.

The ‘Drop Down’ menu bar conforms to normal Microsoft standards so it can be dragged and placed at any of the four sides of your desktop. It is probably most useable left at the top of your desktop.

The following comments apply to ALL menus. To move any menu around on the screen, you ‘drag’ it by **depressing** the LB in the ‘blue’ coloured View Title area, anywhere other than over the ‘X’ in the top right hand corner. With the button still depressed, move the mouse to the desired location and release the button to repin the menu. The same procedures also apply when moving panels and views. When doing this just make sure that LB is clicked in the general heading area and not on a View button.

To ease the learning and usage process, a menu description system has been adopted in this manual that describes where to look to achieve a specific function. For instance, to import an AutoCAD DXF file of point and line data into 12d, you 'Walk Right' on the 12d Model menu or from the 'Drop Down' main menu bar, through two submenus and select DWG/DXF. This instruction is documented as...

File I/O =>Data Input =>DWG/DXF/DXB

To display submenus from the 'Walk Right', you do not need to use the mouse buttons. Simply position the mouse cursor over the 12d Model menu and once 'File I/O' is highlighted, slide the mouse right over the arrow and the 'File I/O' menu will pop up. Slide further right on the 'Data Input' menu item and the 'Data Input' menu will pop up.

Your screen should appear as follows

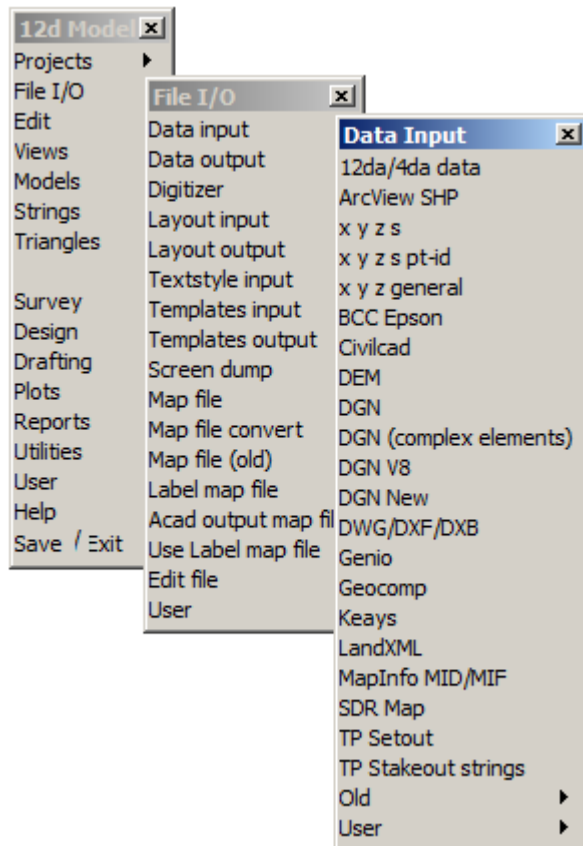

Alternatively, you can use the 'Drop Down' menu bar to get to the same point ...

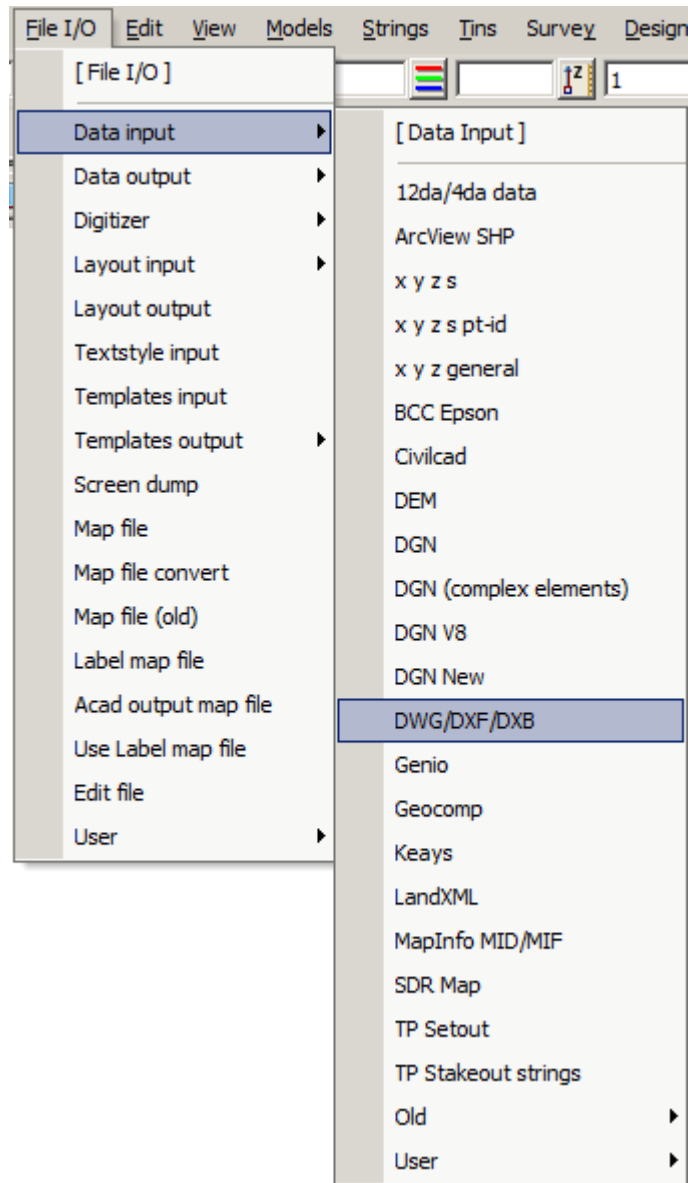

To get to this same point using the pull down system, you need to click LB on [File I/O] on the 'Drop Down' menu bar and then proceed as before on the walk rights as shown below.

Regardless of which menu selection method you used, place the cursor over the words 'DWG/DXF/DXB' and click the left mouse button (LB) once. The 'Read DWG/DXF Data' panel will appear.

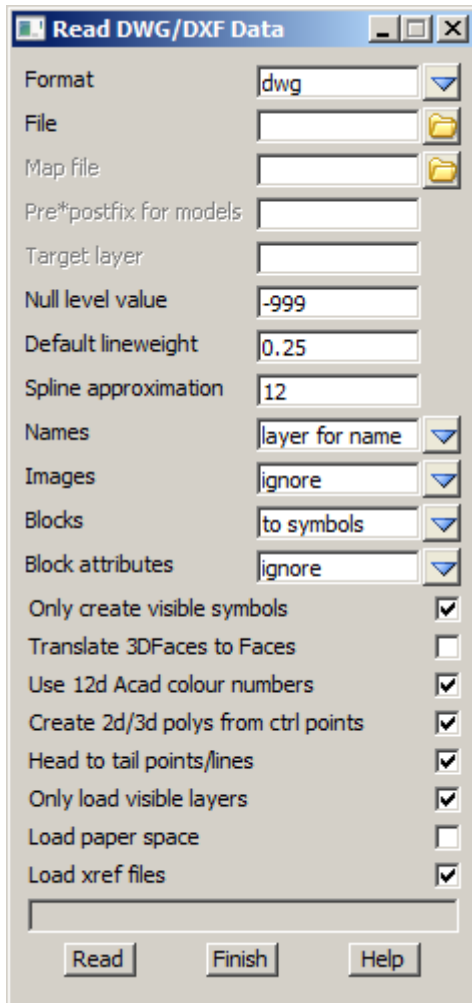

The panel is placed on the screen at the location where the mouse cursor was when LB was clicked.

Once the panel is selected, the Walk Right menu system should collapse and be removed from the screen. If you move and repin any of the menus however, they will not collapse automatically.

If a menu is in the way, you can move it as stated above. Any menu can be removed by clicking LB on the 'X' button in the top right hand corner.

You would normally now start entering data into the panel. At this time, we will not proceed further with this panel. Shut down the panel by clicking LB on the  in the top right hand corner or clicking LB on **Finish** at the base of the panel.

3.5 Toolbars and Controlbars

CAD Toolbar and CAD Controlbar

In 12d Model there are CAD options which are available under both the *Strings =>CAD* menu and on the *CAD Toolbar* on the left hand side of the 12d Model screen.

The **CAD** options create various elements using a number of methods. These options make use of **Tool bars** and **Control bars**. Tool bars just have icons on them but Control bars have icons and also controls such as a model box on them. The method groupings are shown on the toolbars (e.g. Points, Lines etc.).

The user can select an icon on the tool bar and a **Flyout** for all options of the grouping are displayed. This can be done by selecting the appropriate group symbol by holding down the left mouse button on the icon. This shows all the different options for that grouping in a flyout panel. Whilst still holding down the left mouse button, the user can move along the flyout toolbar to the appropriate option.

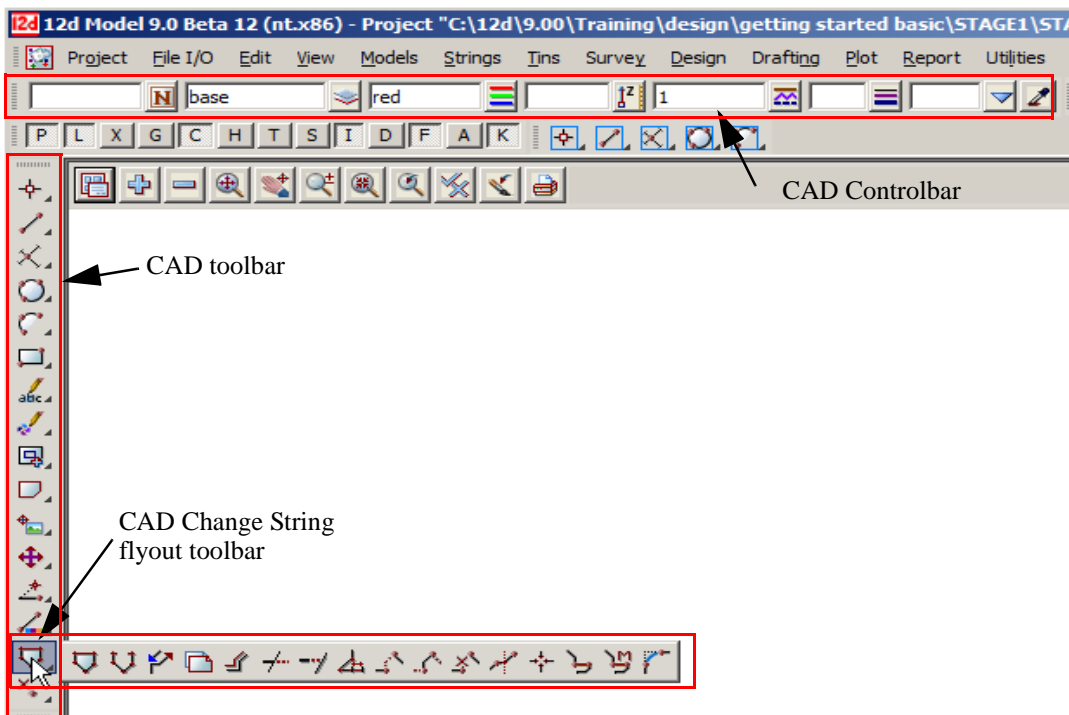

The elements created from the CAD options will have attributes as defined by the **Cad Control Bar**. This control bar is placed on the top left hand side of the screen under the main menu control bar on the creation of a project



The fields and buttons used in this control bar have the following functions.

Field Description	Type	Defaults	Pop-Up
	name box		names.4d names

name of string. If a valid name already exists in names.4d, the [N] button can be used to bring up a choice box of available names. On selection of a valid name, the rest of the values in the control bar will be filled out. e.g. colour, linetype etc.



model box

cogo

existing models

this field can be recognised by the model icon button on the right hand side of the field. The user can select an existing model by selecting the model icon. If a new model is to be used, the user simply types the model name into the field.



colour box

red

standard 12d colours

this field can be recognised by the colour icon button on the right hand side of the field. The user can select a 12d standard colour model by selecting the colour icon



height input

Measures menu

this field allows a height or z value to be assigned to the created elements. If a valid value exists, this value will be applied to the created element. This is regardless if the z value was specified in an XYZ box.

*If no value is specified, the level will be interpolated where possible. A value of **null** can be entered into the height field as well so that created points will be given a null height value.*



linetype box

1

valid linestyles

this field can be recognised by the linestyle icon button on the right hand side of the field. The user can select a valid linestyle by selecting the linestyle icon



weight box

this field allows the user to type in a line weight for the cad item created

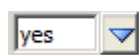

button

the Tenable field sets whether the vertices and segments are tenable (used in triangulations), not tenable (not used in triangulations) or only the vertices (points) are tenable.



button

the eye dropper allows the user to select an existing element which will define the cad control bar values.

The CAD options are available from the CAD toolbar or from the CAD menu under Strings.

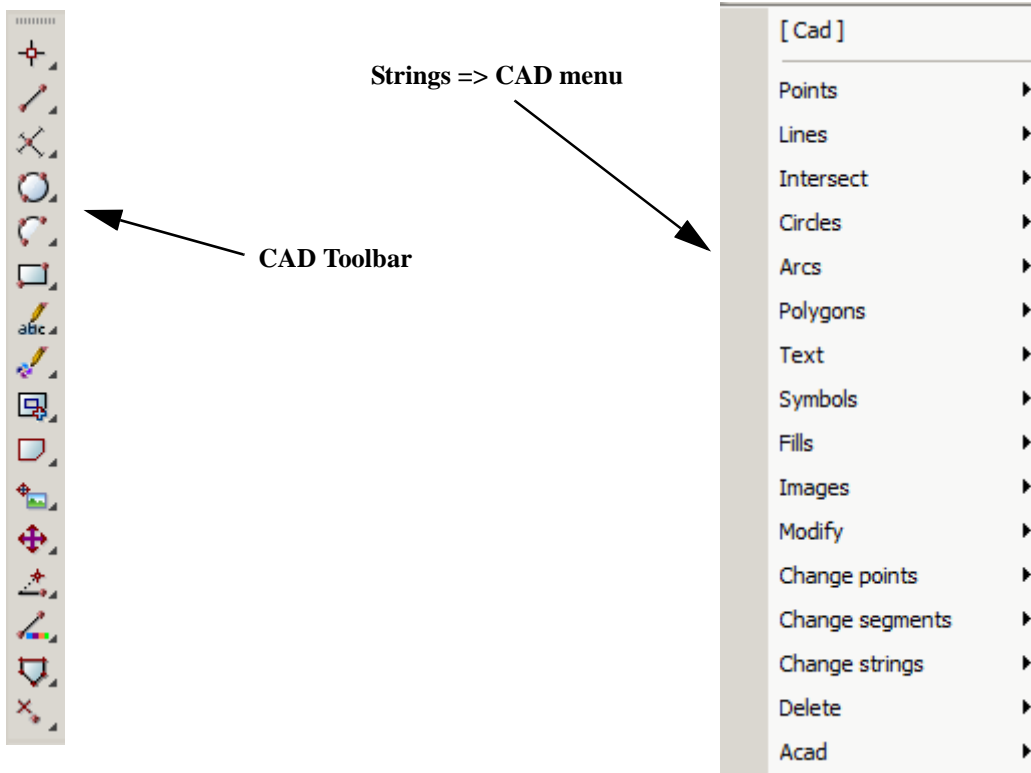

When options are chosen from the CAD Toolbar, help messages are written to the Screen Message Box at the bottom of the 12d Model screen. Since there is no panel or menu involved with the CAD toolbar options, there is nowhere for an F1 key to function for on-line help.

Hence all the CAD options are documented under each of the walk-right menus for the *Strings =>CAD* menu.

CAD Text Toolbar and Text Controlbar

The various **Text** options are:

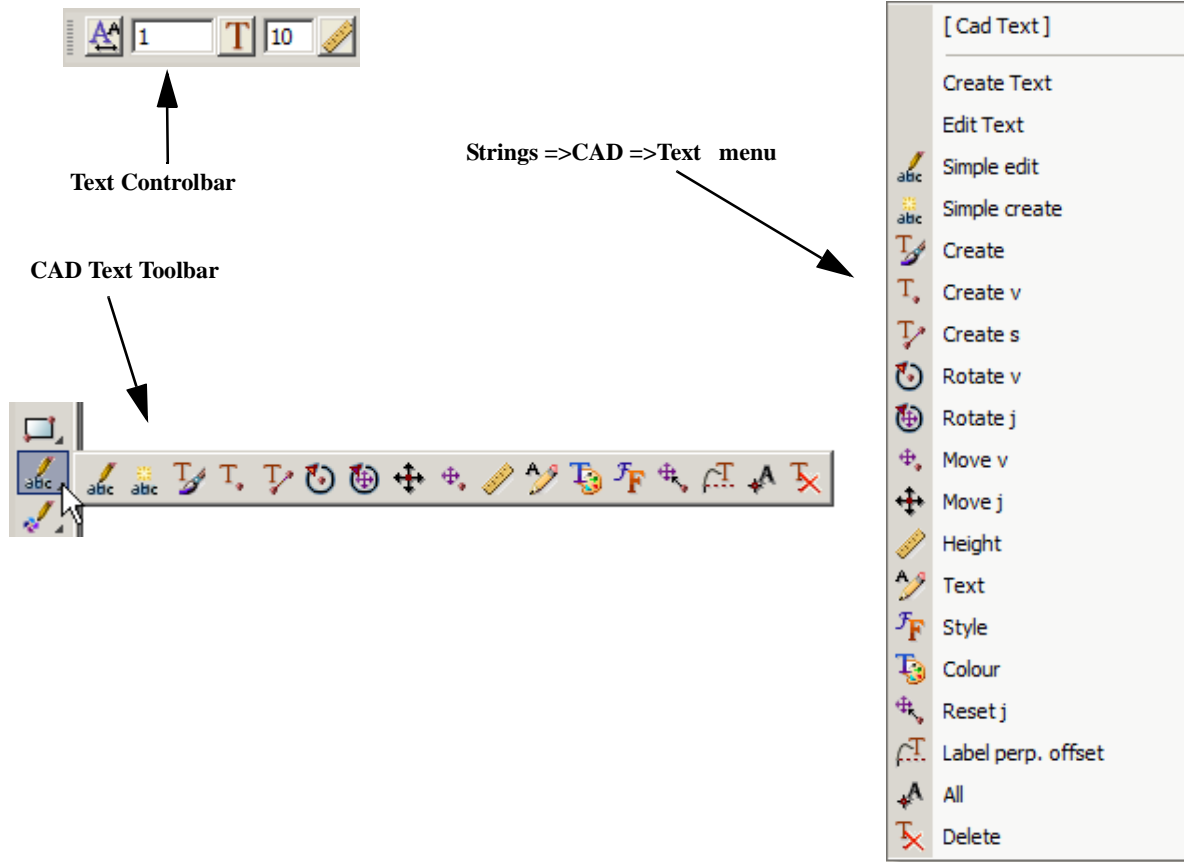

Text can occur as a text string, on vertices of a 4d string, and on vertices and segments of a super string. Each type of text has a vertex (these are displayed when Vertices are toggled on in a plan view), a justification point, a rotation, an offset and a raise value. The vertex and justification point only coincide if the offset and raise values are both zero. All text on a 4d string must have the same height, colour, angle, offset and raise. Each part of the text on a super string vertex segment can be independently modified depending on the settings for the super string.

For text options, the created elements will have attributes as defined by the **Text Control Bar**. This control bar is placed at the top right of the screen under the main menu control bar on the creation of a project



The fields and buttons used in this control bar have the following functions.

Field Description	Type	Defaults	Pop-Up
	Textstyle data box		

On pressing the button a list of available textdata with predefined names read from the `textstyle_names.4d` file are displayed.

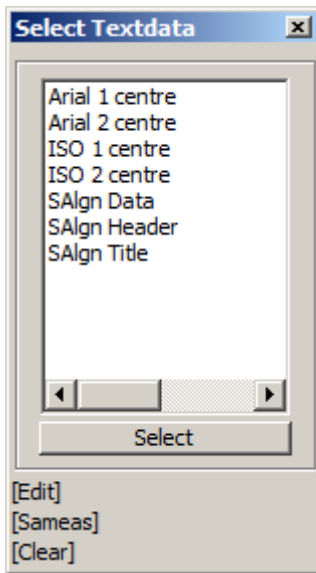

If you require a different textstyle, the user can edit the current settings by selecting the *[Edit]* button to bring up the **textstyle data** panel. This allows for definition of textstyle, units, height offset raise etc.

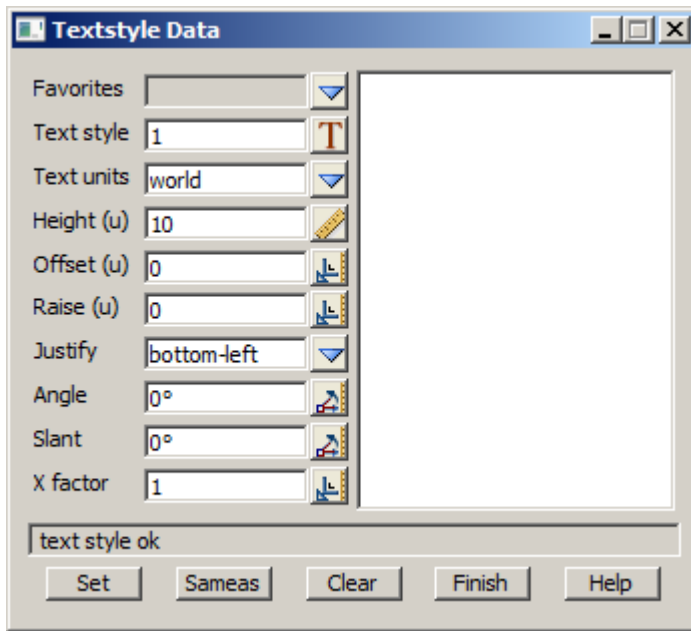

textstyle box 1 available textstyles

the user can select an existing textstyle by selecting the textstyle icon or entering a value into the input box to the left of the button.

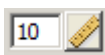

text height box 10

the user can measure a height by selecting the text height icon or entering a value into the input box to the left of the button. The value units are defaulted to world units. This can be changed in the textstyle data box

Symbol Controlbar

The *Symbol Controlbar* is normally at the top right of the 12d Model screen.



Users can define their own symbols to draw at vertices of 12d Model strings. The definition of symbols are stored in a file called symbols.4d.

The fields and buttons used in this control bar have the following functions.

Field Description	Type	Defaults	Pop-Up
-------------------	------	----------	--------



Symbol data box

On pressing the *Symbol data* button a panel appears

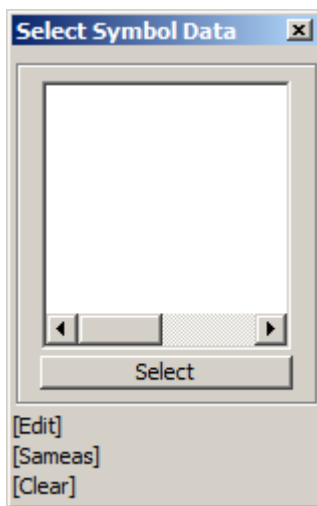

*If you require a different symbol, the user can edit the current settings by selecting the [Edit] button to bring up the **Symbol Information** panel (shown below).*

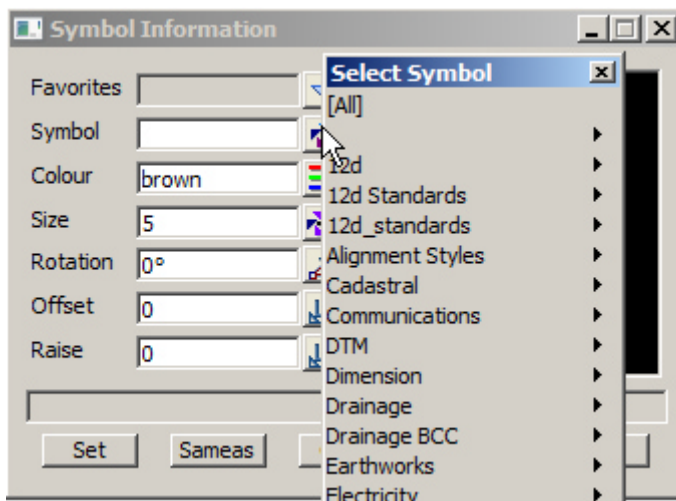

The current symbol can be selected from the Symbols list and the colour, size and rotation can be manually set

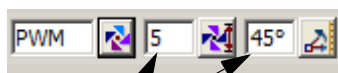

Alternatively the size and rotation (anti clockwise) can be entered manually into the boxes in the Control bar

Search Toolbar

The *Search bar* is normally at the top right of the 12d Model screen.



Users can type in words (or part) to describe the option they require and a list of menus appear when the parameters are met

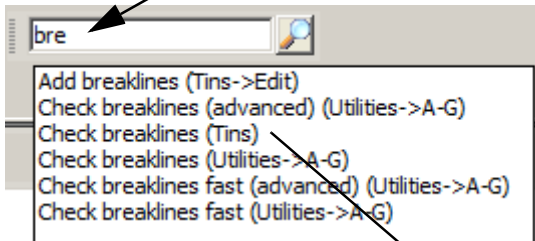

Double clicking LB on the Topic activates the menu

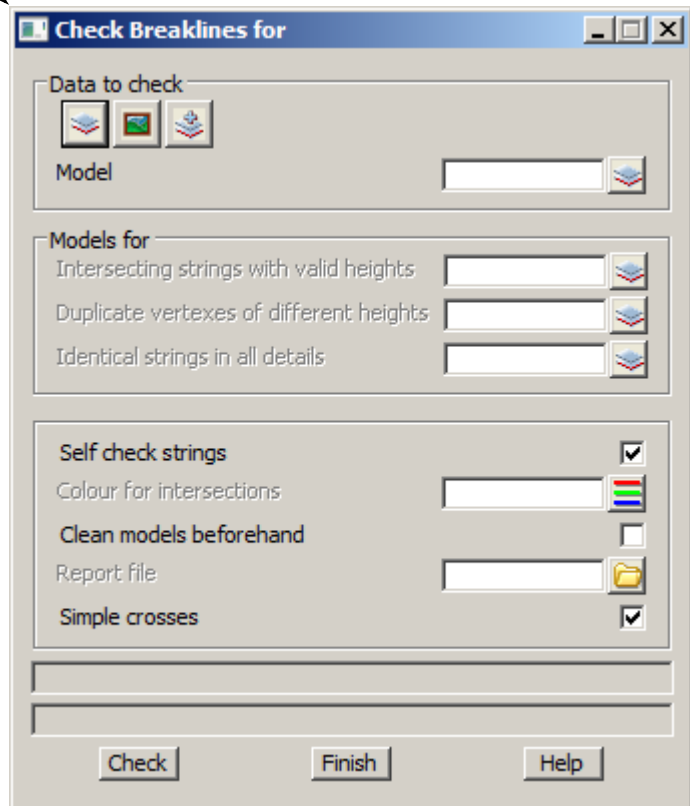

Snaps Toolbar

The *Snaps Toolbar* is normally at the top right hand corner of the 12d Model screen.

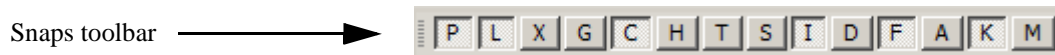

Snaps are used when picking strings - see Chapter 7.4 'Snap Settings'.

3.6 Status Bar

The Status Bar is an optional part of your desktop. It appears at the base of your desktop. The Status Bar contains the Screen Message Box and the View Coordinates Box. It is strongly recommended that you keep it turned ON.

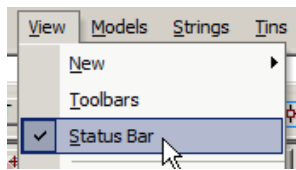

If desired, the Status Bar may be turned OFF at any time. From the **View** drop down menu bar, click LB on **View**, untick the **Status Bar** checkbox. To turn it back ON, repeat the selection but this time tick the checkbox.

3.7 Screen Message Box

The Screen Message Box contains messages that help you interact with the 12d menus. For instance, when importing a DWG/DXF/DXB file as shown previously, you have to select a file name to read. Let us investigate the messages 12d gives us to help us with this simple operation.

If the DWG/DXF/DXB Data panel is not already showing, select it again as shown previously. Click in the 'File' name entry data field. Observe that the following response appears in the Screen Message Box

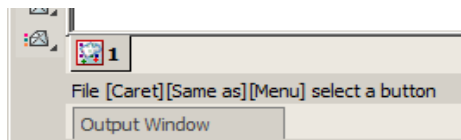

You interpret this help message as follows. 12d is asking you to supply a file name. The three sets of square brackets [] correspond to your response via the three mouse buttons, LB, MB and RB.

The LB message 'Caret' indicates the position of the cursor if you want to type an answer using the keyboard.

To type an answer, you must first make sure that the cursor is locked onto the field you wish to modify. The cursor must appear as a flashing vertical bar before 12d will accept any data from the keyboard. You can reposition the caret anywhere in the existing word by using the LB. You could then edit it by using the 'Backspace' key. Alternatively you can use the 'Delete' key to delete the character to the right of the cursor or the Arrow keys to move within the word. The 'Home' and 'End' keys take you to either end of the existing entry. To delete the entire entry, double click anywhere in the text to highlight it. Then press the delete key to erase the entry or just start typing to replace it.

The MB message 'Same As' indicates that you can point at any existing item on your desktop. This would not normally be used for a file name.

The RB message 'Menu' puts up a menu. At this time, no items are available. If another filename was copied to the windows clipboard then the 'Paste' would be highlighted.

Or finally, you can click LB on the folder icon to locate the required file

The Screen Message Box area changes dynamically with the position of the cursor on the screen so watch it closely for helpful messages.

3.8 View Coordinates Box

Note the location of the View Coordinates Box at the bottom right of the desktop. This box displays the X-Y coordinates of the cursor when in a Plan view and Chainage-Height when in a Section view.

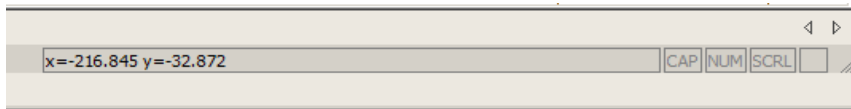

3.9 The Output Window

The Output Window appears as a tab at the bottom left of the screen and flashes if there are any messages that need to be reviewed. This Window can be pinned to your desktop, but to maximise use of your desktop for 12d views etc., it is best to leave it as is. You can also convert the output window to a view, just like a 12d View.

To turn the Output Window OFF at any time, you need to access the menu bar that appears across the top of your desktop. From the Window Drop Down menu bar, click LB on **Window**, untick the **Output Window** checkbox. To turn it back ON, repeat the selection but this time tick the checkbox.

To make the Output Window appear as a normal Window on you desktop, place the cursor anywhere over the 'white' background area of the Output Window and click RB. In the pop up menu, click on the **Convert to Window** menu with the LB. The command Window will then appear somewhere on your desktop as a Window. It may be moved by clicking LB in the blue Output Window heading area, dragging the cursor to another part of your desktop and releasing the LB to pin it down.

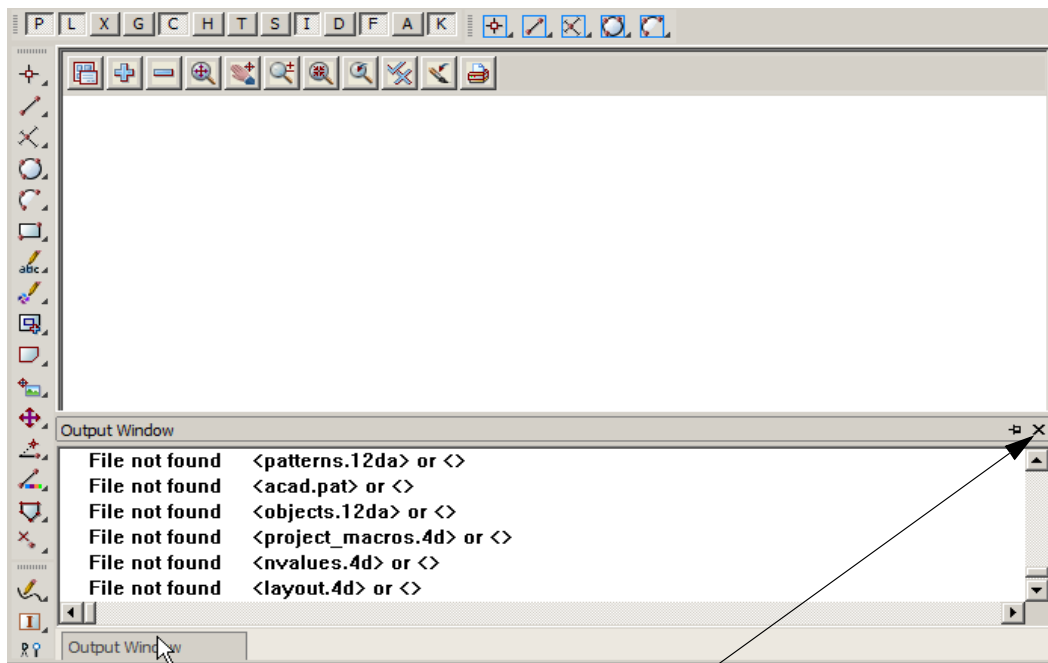

If you wish to close the "floating" Output Window just click on x as you would with any other view.

There are three view types available in 12d. They are Plan, Section and Perspective. It is possible to have multiple plan, section and perspective views on the desktop at one time, each showing different information. There is no limit to the number of views you may create.



Each View has a View type icon and name such as 'SURVEY' or '2' etc.

The name appear in the View Title Area. This is the blue heading at the top of each view. Just below the name is the View Button Area which contains the most common View buttons (i.e. a subset of the complete list of view options). The View buttons appears horizontally after the view name. The View Button Area appears automatically with each view as the view is created and each view type has different view buttons that reflect it's characteristics. The view name defaults to a number but can be over typed with any alphanumeric.

The view buttons on the Plan view are:

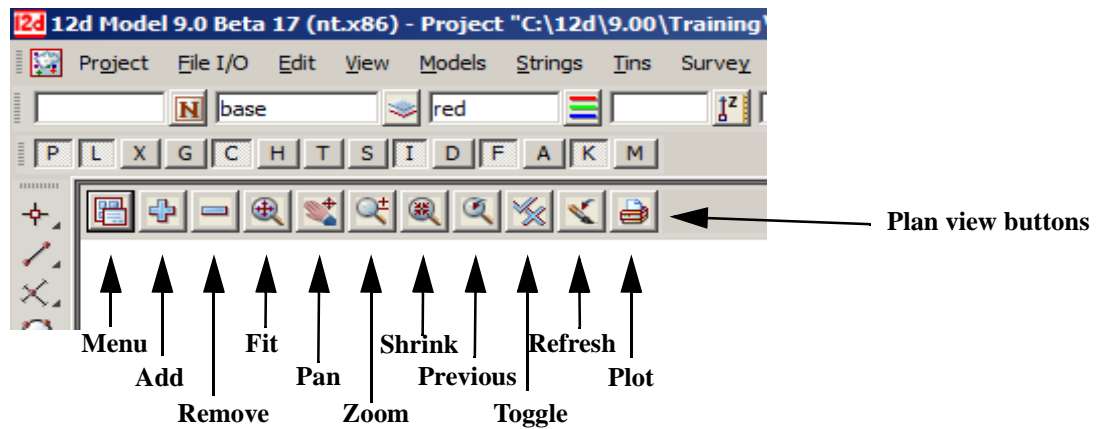

Each view also has its own menu (the view menu) which can be brought up by clicking the LB on the view button called **Menu**.

The View menus can also be brought up in another special way:

if you click the RB in the View Button Area or the View Title Area, you will also get the View menu to pop up. Clicking RB again in the View Button Area or the View Title Area will remove the view menu.

So by using the RB, view menus can be accessed even if the Menu item is not visible in the View Button Area.

The View menu contain options available for that particular view type. It is a superset of the buttons that appear on the horizontal View Button Area. If the View is made very small or moved off the right hand side of the desktop, the various buttons on the horizontal View Button Area will not be selectable as they will not be visible. In such case, you have to use the RB in the View Button Area to get access to the various View menu items.

Views may be created, resized, overlapped, moved and deleted as required. When you create a new view, 12d will automatically supply it an ascending number for reference purposes e.g. 'Section 2'. Views can overlap Menus and Panels that are already on the desktop.

Hence there are four menu systems in 12d, one for each view type (plan, section and perspective) and an overall main menu.

3.10 Basic View Operations

We will now practice some basic View operations

To create a new View, select **Views=>New=>Plan** from the main menu to create a view with the next view number.

Alternatively, you can use **Views=>Create=>Plan View**. Pick **Create** with the LB after first supplying a View name or accepting the 'number' supplied by 12d as the View name.

Once the View is on display, the following operations can be performed from the View Button Area at the 'top' of the View. To move a View to a new location on your desktop, depress the LB in the View Title Area – the 'blue' area showing the words '**Plan 1**'. Whilst you still have the mouse button depressed, drag the mouse and you will see the View move. 'Pin' the View again by releasing the LB.

Use the standard Windows features to change the size of the View. Place the cursor near any corner or midside of the existing plan view and when the drag arrows popup, depress and hold down the LB and drag the mouse to see the Window size change. Pin the new location of the corner by releasing the LB.

To delete a View just click LB on the '**X**' button in the top right hand corner of the view.

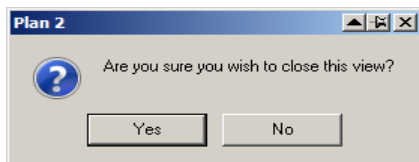

Click LB on [Yes] to confirm the action

You can also delete a view by clicking LB on the Menu button in the View Button area to popup the View menu and then click LB on **Delete**.

For the purpose of the tutorial, leave one large Plan View '1' on the desktop. We will subsequently demonstrate how the various views are linked. Information in a Plan view can also appear in Section and Perspective views for instance.

3.11 Introduction to Models

Models are a 12d concept also present in most CAD systems. It is similar for instance to the layering concept AutoCAD, or levels in Microstation. Basically each model represents a repository for data. Each point or line that is created or imported into 12d is put into a model. By turning models 'On' and 'Off', it is possible to change the amount of information that is displayed. This control is provided in each view so it is possible to have different models on display in different views.

It is important to note that the data in the various models is always permanently stored in 12d. It is a user controlled convention to only show a subset of models at any one time.

There is no limit to the number of models used in any one 12d Project.

If you want multiple copies of a certain line (i.e. string), it is possible for instance to copy the line from one model to another. The lines can then be displayed independently. If both models were on at once, the information will appear as one line instead of two since the strings are coincident. It is possible to selectively snap to and edit either line in such a case.

At any time, individual models can be **Renamed**, **Duplicated**, **Cleaned** (removes all points and lines but the name of the model is retained) or **Deleted**.

A new feature in version 9 is the **Trash Bin**. Any deleted models will be store here as a back up. Deleted models can be restored at a later time. An example of this will be shown later in the manual.

Models can be temporarily **Removed** (from selection lists) and subsequently reinstated through the **Add** function.

It is also possible to copy models between projects (See **Models=>Utilities=>Copy Project Models**). These are advanced features of 12d that we need not concern ourselves with at this time.

3.12 Introduction to Strings

12d is very much a 'strings' rather than 'points' based system. In it's simplest form, a string is a line between two points or vertices. In fact a single vertex is also a special type of string known as a 'point string'. A string may be made up of multiple straight line segments connecting many points (vertices). Strings may contain curves and arcs as well as straight lines. Strings vary in complexity from 2d (x,y and constant z value) to multidimensional (e.g. an alignment string has both horizontal and vertical geometry independently defined). In general, as well as x, y and z values, strings have properties such as string name, string type, string colour, line style, and chainage. Strings also have a 'point/line' property that can be set such that they appear as 'disconnected points' or 'connected lines'. From a design point of view, strings are much more useful than points.

3.13 Introduction to Panels

A panel is simply a means of supplying multiple answers to 12d in a concise manner. Once a panel appears on the desktop, you can use the mouse or the Tab and BackTab keys to position the cursor over any data field. Remember, when typing data from the keyboard, the cursor must be flashing in the data field for characters to be accepted.

When supplying data to a 12d panel, you do not need to terminate the entry of data into a field by pressing the *Enter* key. For instance, you can use the Tab and BackTab keys or the mouse to move to another field after entering data. If you do press the *Enter* key to terminate the entry of data into a field, 12d will immediately validate the data in that field and supply an error message if appropriate.

When validating 12d supplied or previously entered data in other words, where you do not need to change the data in a field - it is not necessary to place the cursor in the data field. Just press the *Enter* key to pass through each field in the panel in turn.

When typing data into a field, please observe that the 'Delete' key deletes a single character to the right of the cursor. The 'Backspace' key is also active. If you need to delete multiple characters, drag the LB across the characters to highlight them (or double click over a word) and press the 'Delete' key to delete them or start typing to replace them.

In general, 12d has been setup so that data can be selected from lists rather than typed from the keyboard. When entering data into a field, if there is a list of alternatives already known to 12d, pressing the LB at the icon the end of the field will display the list.

To practice this, bring up the 'Read xyzs Data' panel - from the Main menu, click LB on

File I/O =>Data Input =>xyzs

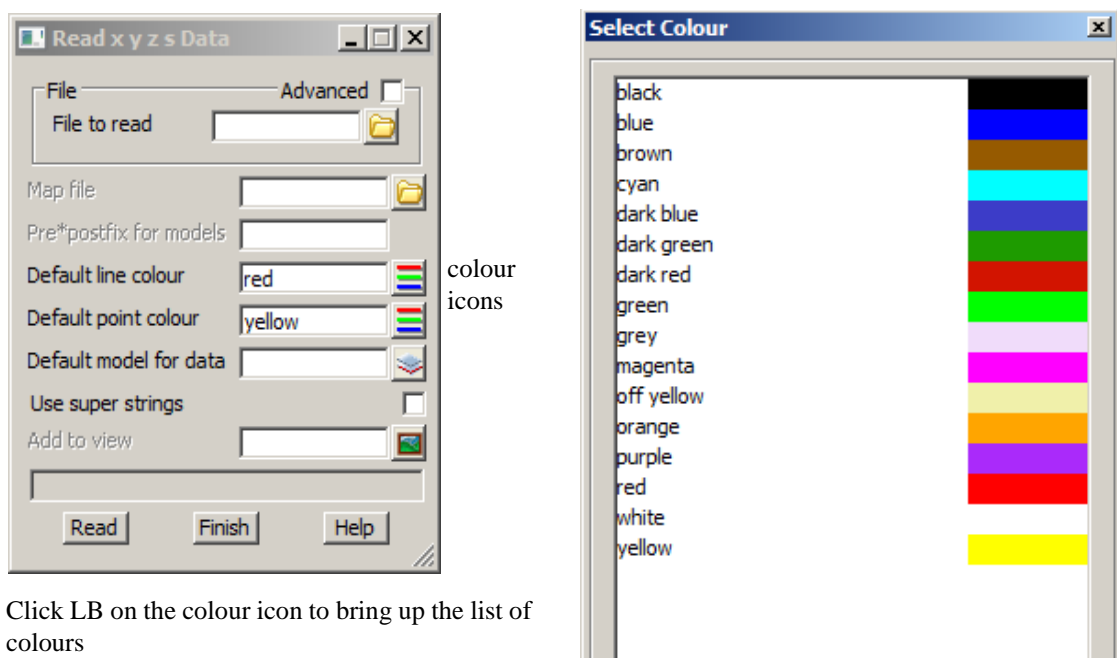

Click LB on the colour icon to bring up the list of colours

Set the 'Default line colour' in the above panel to 'dark green' by clicking LB on the colour icon (the little white box to the right of the word 'white' in the fourth data field). A list of available colours will pop up. Use the mouse to click LB on 'dark green' and then process it by clicking LB on the **Select** button at the base of the panel.

Alternatives: You can double click LB on 'dark green' to short-cut this sequence. You could also have used the down arrow key to work your way down through the list to highlight the word 'dark green' and then pressed the Enter key.

In a manner similar to the colour panel field just discussed, most panel fields have a pop-up list of choices available and the list is activated by clicking on the icon at the right hand end of the panel field. Some times there will be a special icon such as the *colour* icon in the previous example or the file box icon at the end of the *File* field of the **Read DWG/DXF Data** panel.

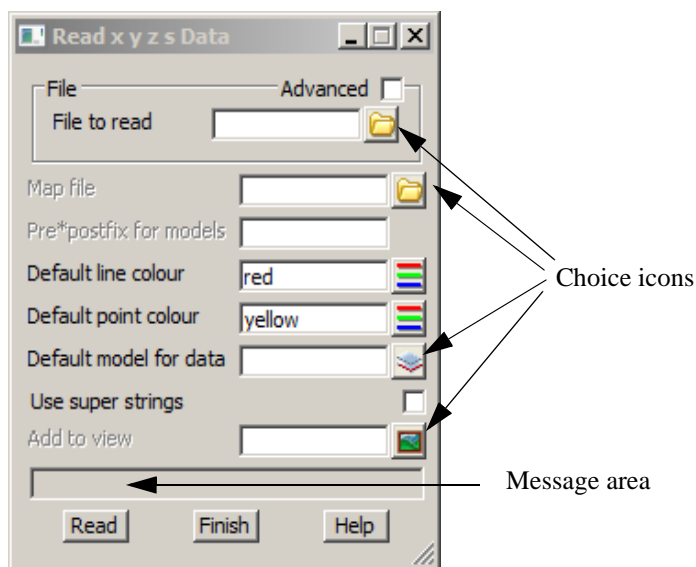

Other icons that may be used are:

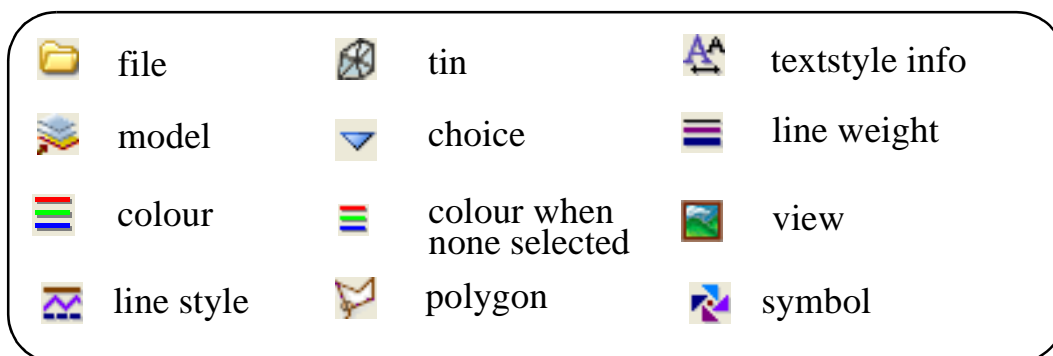

Note the message area at the base of the panel (just above the **Read** button in the **Read xyzs Data** panel). Each panel has its own message area to help you interact with 12d. If 12d does not appear to be working the way you think it should, you will often get helpful information in the Panel Message area if you make a mistake. Look in the Screen Message Box as well as it is also updated when interacting with panels.

If a panel is in the way, you can move it as stated above. Any panel can be removed (shut down) by clicking LB on the 'X' button in the top right hand corner or by clicking on the **Finish** button.

If you want to keep a panel that is already filled in such that you can refer to it later, you may decide to temporarily minimise it by clicking LB on the '-' button. It can later be maximised again by clicking LB on the 'overlapping windows' button (where the '-' used to be).

As we don't wish to proceed further with this panel click LB on **Finish** or click LB on the 'X' button in the top right hand corner of the panel.

4 12d Model Help

The 12d Help can be accessed by selecting *12d Model* on the *Help* menu item on the main 12d Model menu.

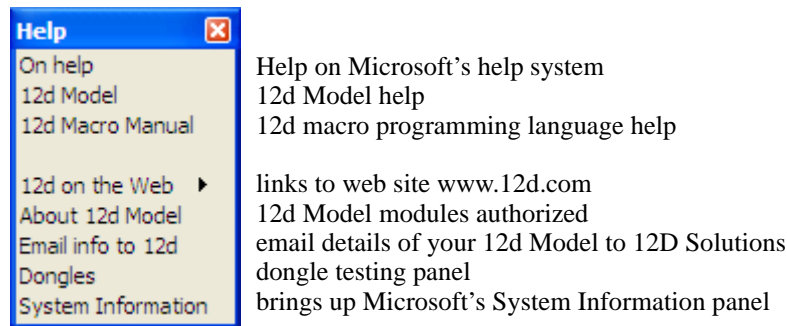

Alternatively, individual topics for a panel or menu can be invoked by using the **F1** key or the **Help** button on any 12d Model panel.

More information on the Help system will now be given.

Contents

The **Contents** allows you to look at the overall structure of the Help and access any part of it.

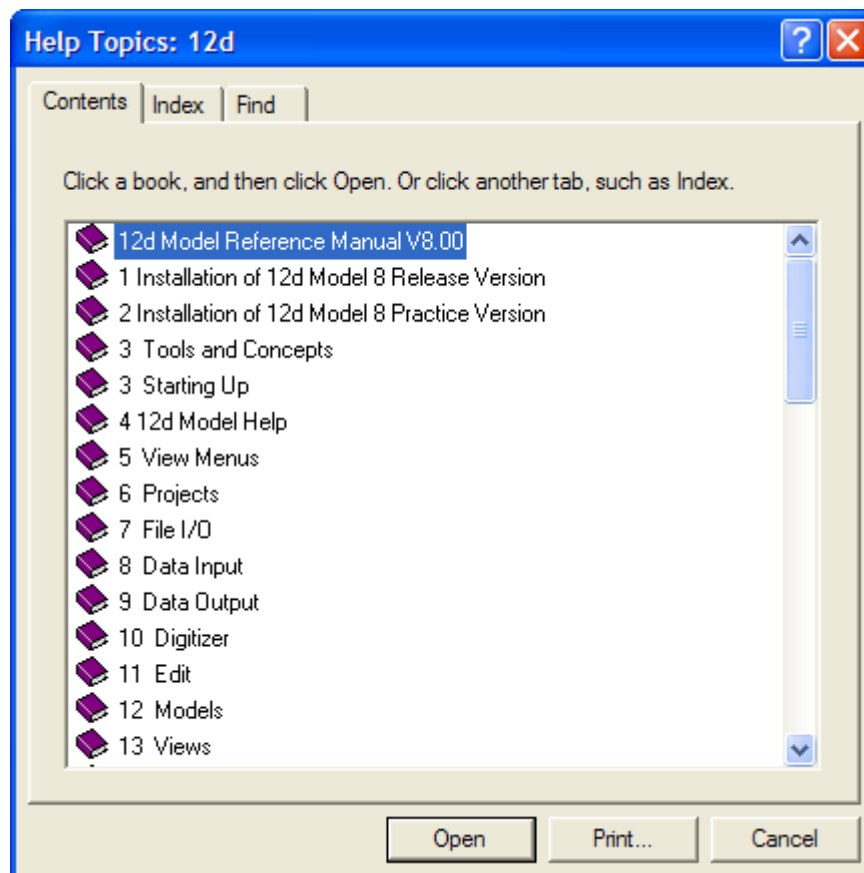

Warning - only *topics* in the Help can be accessed through the *Contents* list so any folders in the Content folders must be expanded until topics are displayed. *Topics* can be easily identified because they have a question mark beside them indicating that Help is available.

For example, double clicking on *Tools and Concepts* expands the next level of *Tools and Contents*.

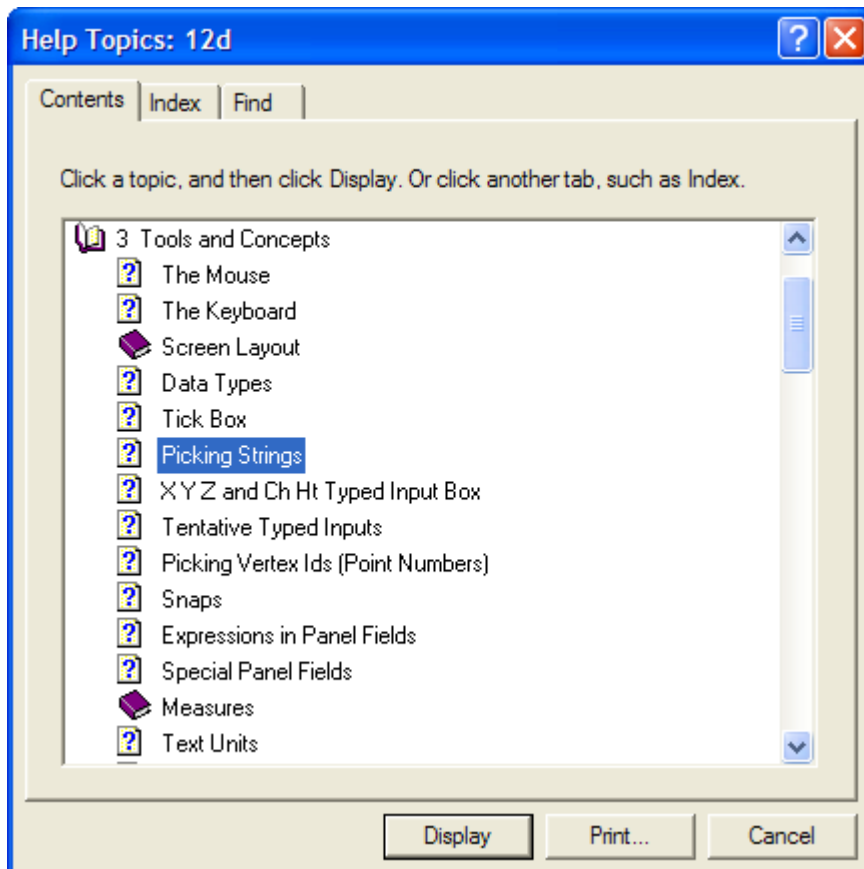

Double clicking on the topic *Picking Strings* will then display the topic.

The *Contents* then disappear leaving *Help* open at the selected topic.

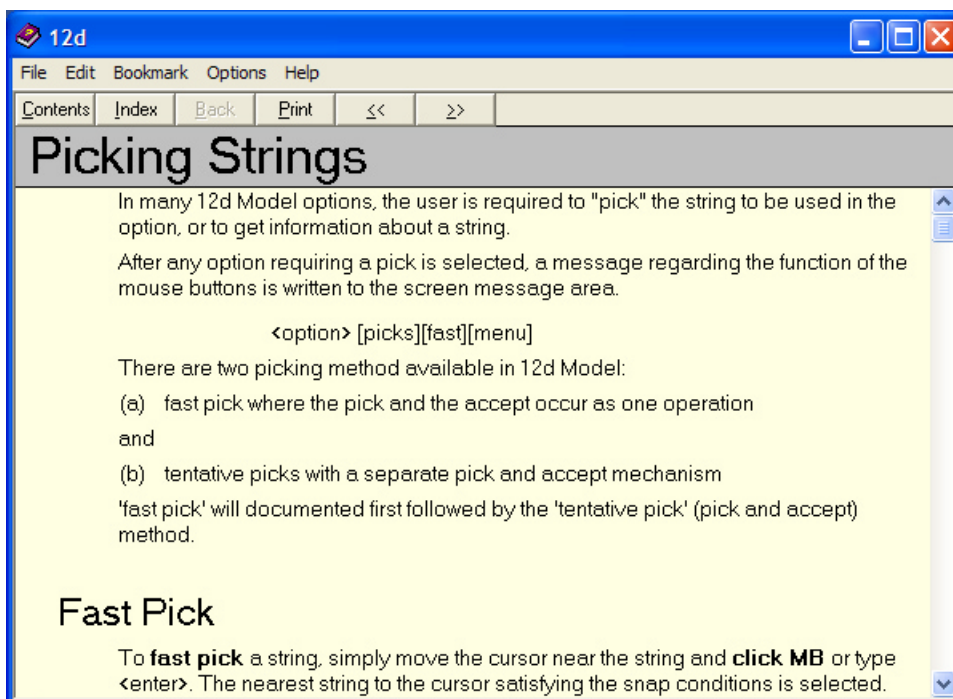

Double clicking on *Contents* on the top of the Help will bring the Contents listing back up.

Index

The *Index* option searches through all entries in the Index of the Help.

As the first few characters of the required entry are typed in, the matching index entries are displayed.

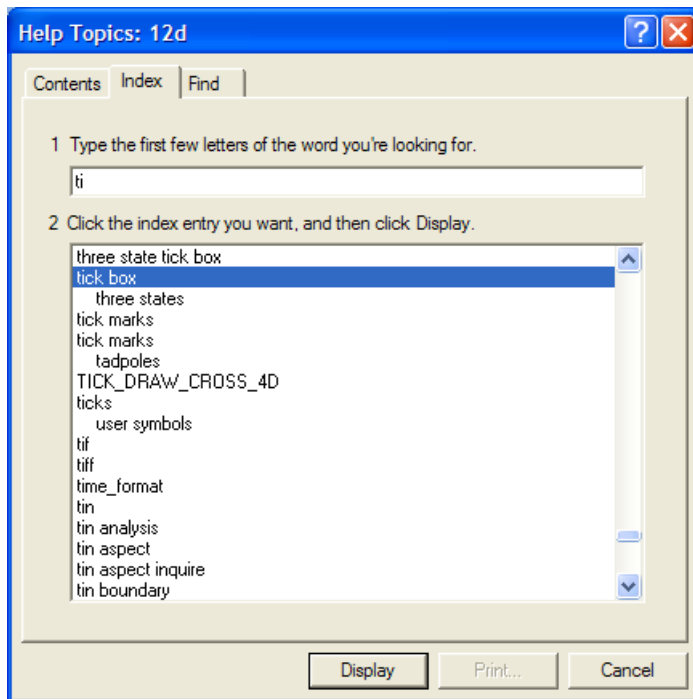

Double clicking on the displayed entries will go to the topic in the Help containing the selected index entry. If more than one topic includes the index entry, then the list of topics is displayed.

If the index has sub-indices, they can be searched by first typing in the main index followed by a comma, then a space and the first few characters of the sub-index.

Find

The most powerful searching method for the Help system is *Find*.

Simply click on the *Find* tab to search for words or phrases that may be contained in a Help topic.

If *Find* is being invoked for the first time, the *Find Setup Wizard* runs to create an index of every word in the Help.

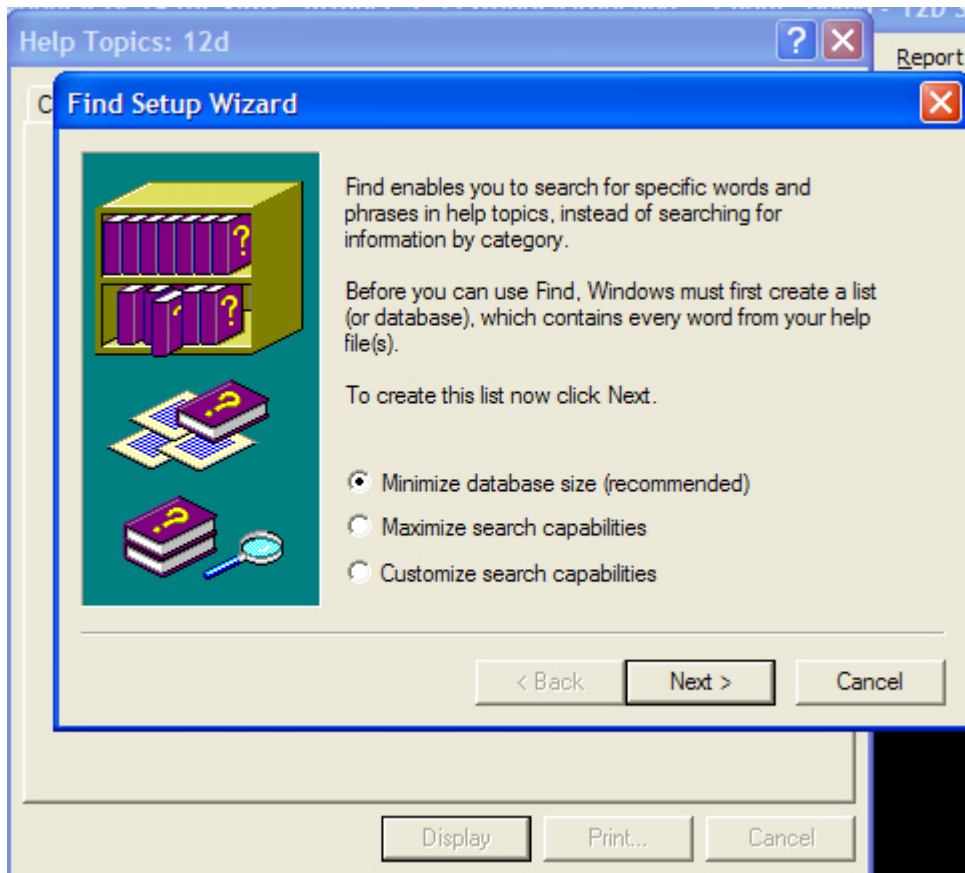

From then on, selecting the *Find* tab goes straight to the *Find* screen.

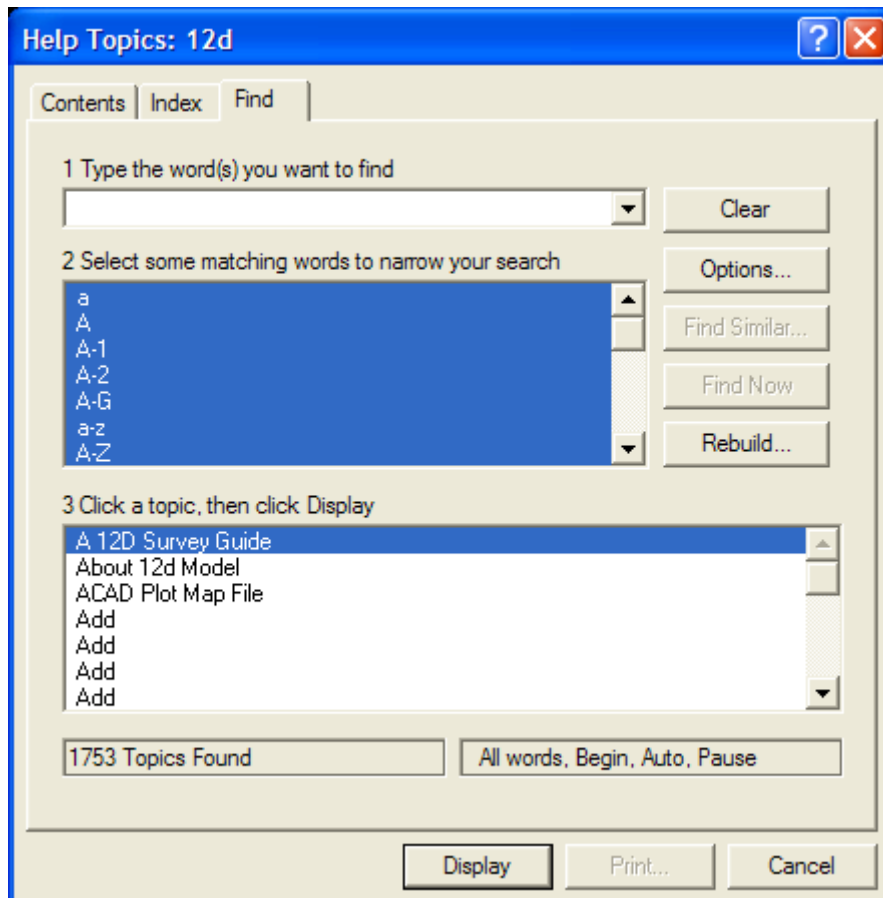

Panel Help Button

Every panel has a Help button which when selected goes to the *topic* describing that panel.

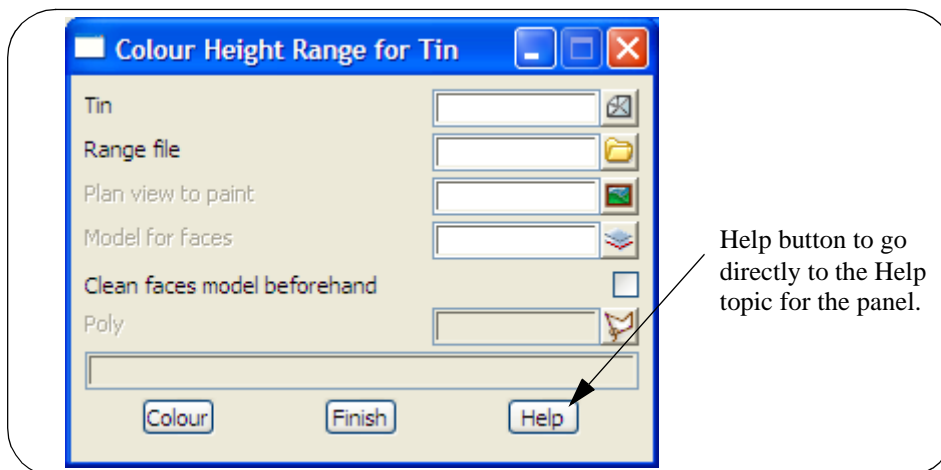

F1 Key

Another method of invoking Help is by using the F1 key as follows:

when a menu or panel is on the screen and has focus (the menu or panel title area will be highlighted), pressing F1 will bring up the help for that menu or panel.

Warning - some of the items on the *Strings* menu automatically start up a string select and change the focus from the panel to a View. This means that pressing F1 will bring up the Help for the View and not the Help for the panel.

To get Help for such a panel, click on the panel to bring the focus back to the panel before pressing F1. The top of the panel will highlight showing that it has focus.

Navigating in Help

Once at a *topic* in the Help, the << and >> buttons at the top of the Help topic will go to the previous and next Help topics respectively.

Individual Help topics can be printed by clicking **Print** at the top of the Help page.

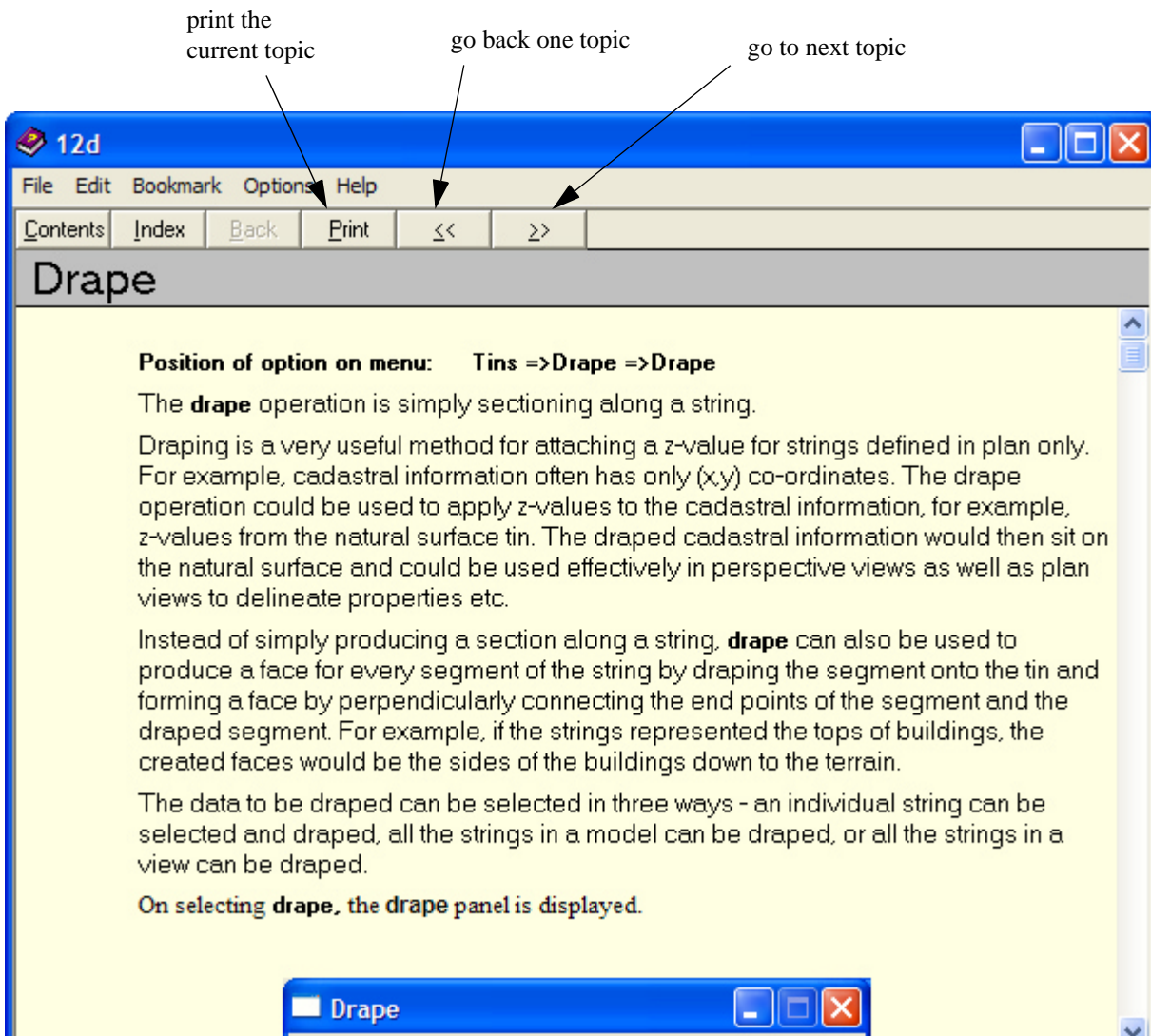

Because it is difficult to print large sections of Microsoft's Help system, a PDF file of the entire *12d Model Reference Manual* has been created and can be used to print out large sections of the manual.

The *12d Model Reference Manual* PDF file is on the *12d Model 9 Installation DVD* in the folder Documentation\Reference_Manual.

5 Starting the Tutorial

Before starting your tutorial, it is assumed that your overall desktop layout is as shown at the end of Chapter 4.3, i.e. one large plan view on display called 'Plan 1'.

5.1 Importing Point Data into 12d

The easiest way to understand the use of Models and Panels is to import some data into 12d and see by example.

Point and Line data can be imported into 12d from a variety of sources. For the purposes of the tutorial, we will use the simplest of these - a simple ASCII file containing point number, x, y and z coordinates along with a code and string number.

We will begin by reading in a Points file called 'DETAIL SURVEY.csv'.

This file lies in the folder **C:\12d\9.00\Training\design\getting started basic**

```
1,42518.873,36865.368,71.833,DR,1
2,42535.232,36859.942,69.805,DR,1
3,42556.394,36847.968,69.349,DR,1
4,42572.709,36848.796,67.75,DR,1
5,42592.277,36848.967,65.879,DR,1
6,42606.098,36848.526,64.818,DR,1
7,42612.6,36847.949,64.739,DR,1
8,42410.27,36954.217,72.574,DR,2
9,42419.677,36955.067,71.904,DR,2
10,42433.789,36954.863,70.552,DR,2
11,42446.673,36955.149,69.777,DR,2
12,42460.181,36955.284,68.955,DR,2
13,42474.806,36955.092,68.24,DR,2
```

The format is one point per line containing a point number, x, y and z coordinate, string name and string number all separated by commas.

To read in the file, click LB on **File I/O =>Data Input =>x y z general** from the Main menu.

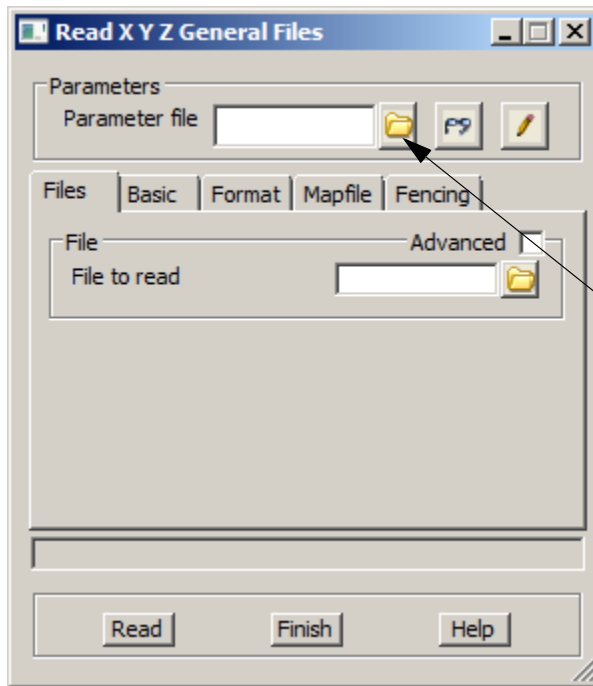

12d gives you the ability to fill in this panel once and then save the setup to a parameter file. This allows you, on subsequent occasions, to call up the parameter file and then you only need select the data file to be read.

To make things easier we have already created a parameter file and stored it in **Getting Started Basic** folder.

Click on the folder icon at the end of the *Parameter file* field.

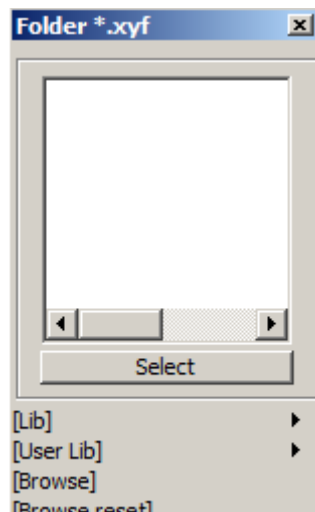

A blank folder panel will pop up, but we will browse for the parameter file

Click LB on [Browse]

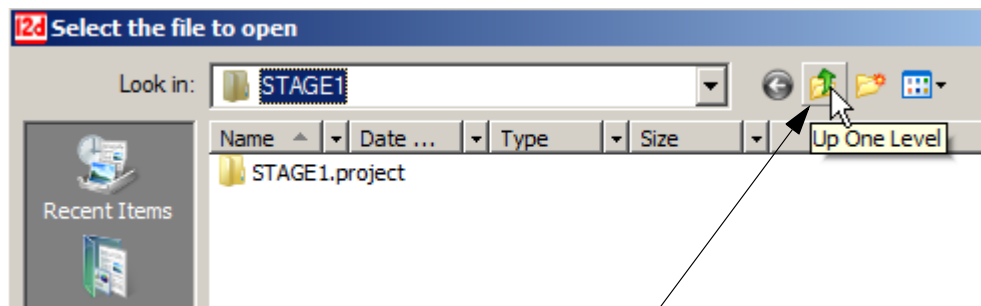

Click LB on the "Up one Level" icon to move back to the getting started basic folder

Note that if you have created the training project in a folder different to the one shown here then you will have to navigate to the required folder

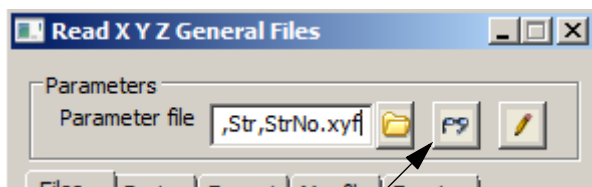
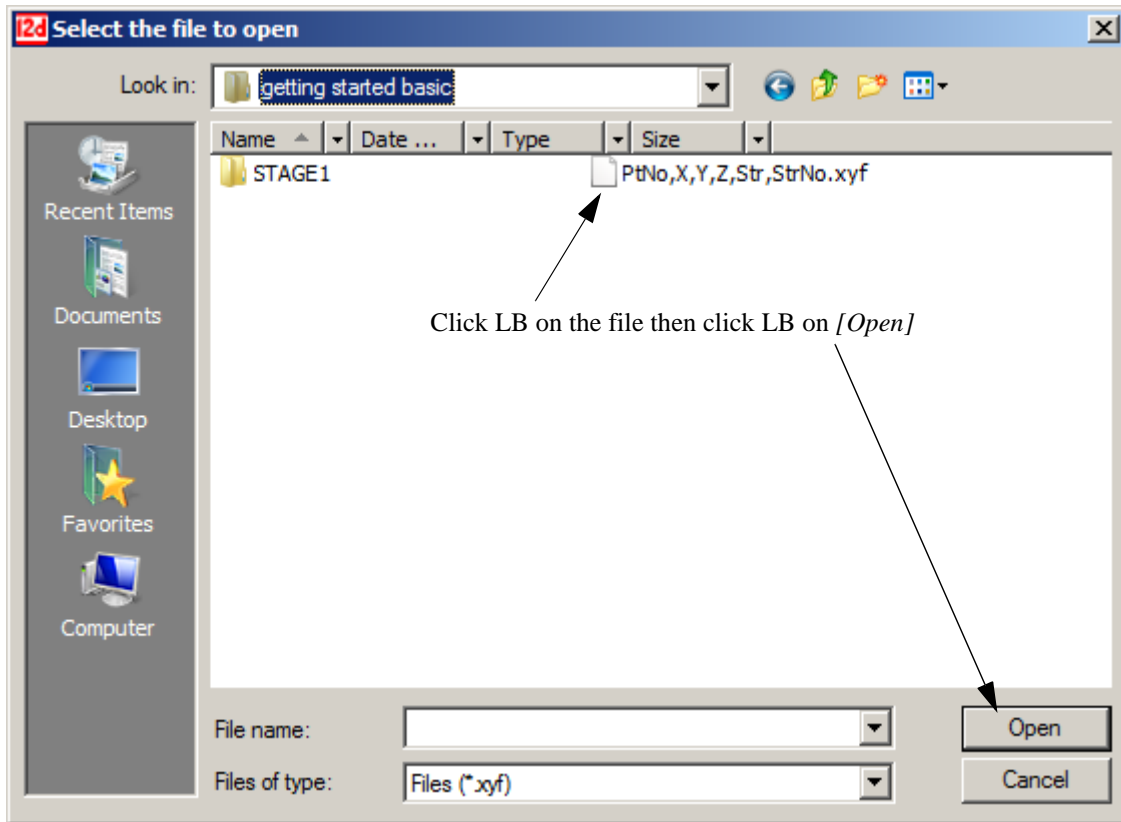

Click LB on *Read* icon to load the parameters

Select the **Files** tab

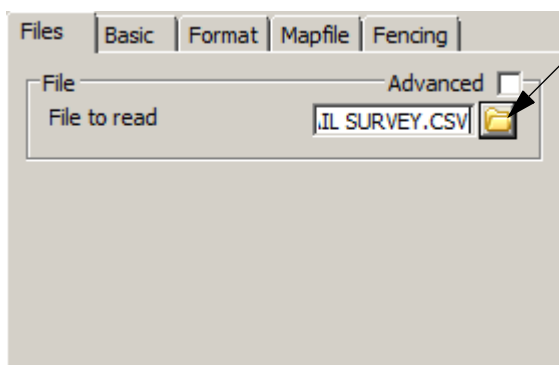

Using the folder icon browse to the same folder that held the parameter file (C:\12d\9.00\Training\design\getting started basic) and locate the file DETAIL SURVEY.csv. You will have to change the *File type* display to *All files (*.*)*

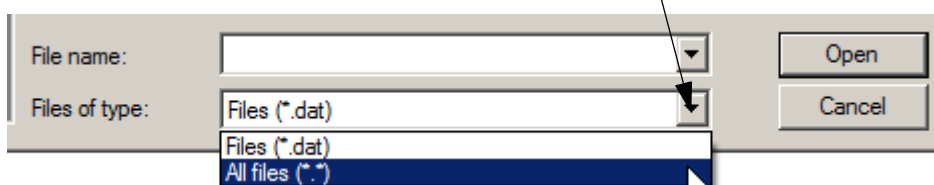

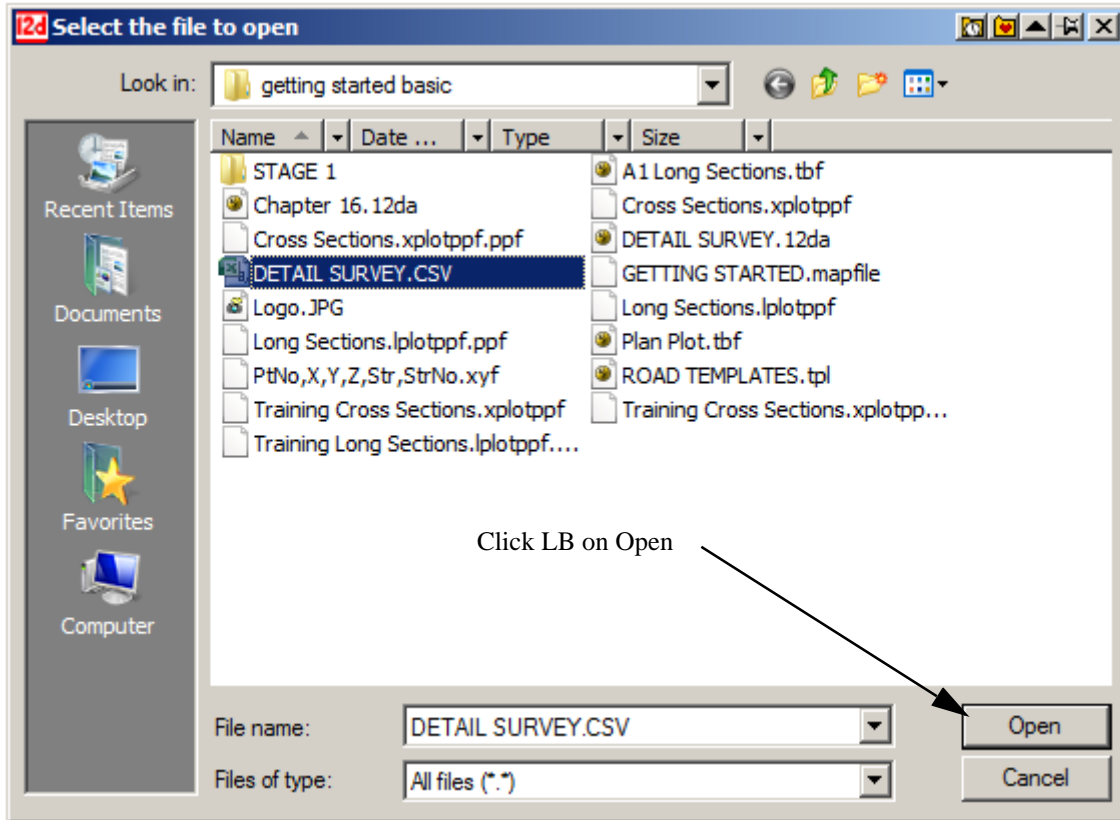

Select the **Basic** tab

The default values for the data are set up here

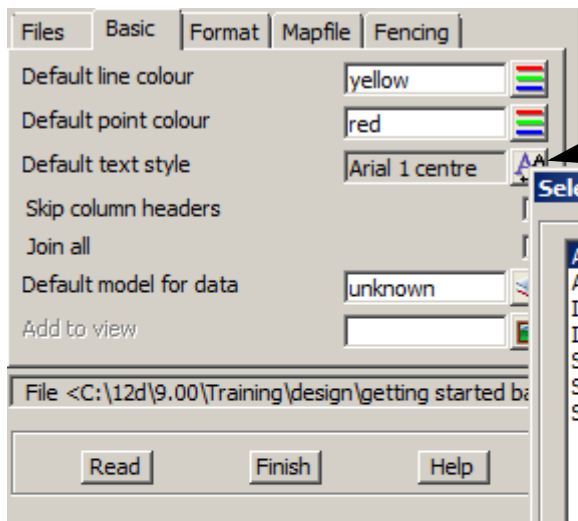

You will notice that the panel is mostly filled in from the parameter file. However, you still need to set the default text field

Select the choice icon then select any of the text style

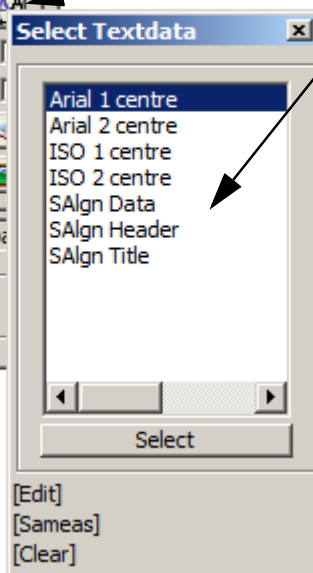

A default model is used in case the data has coding that the mapping file (See **Mapfile** tab) can not recognise.

Select the **Format** tab

The format for the file values are set up here. No user entry is needed for this section

Information Type	Position #
1 point id	1
2 x coord	2
3 y coord	3
4 z coord	4
5 string name	5
6 string number	6

Attribute Mode	Name	Type	Position #
1			

Select the **Mapfile** tab

A user defined mapping file uses the code found in the data file to set the parameters for the strings including the model name, linestyle and colour and more . The map file GETTING STARTED.mapfile was read from the folder **C:\12d\9.00\Training\design\getting started basic**

A model prefix (**survey**) is used to group the survey models together after the map file has set the model names. This will help keep the survey data separate from the design. Using lower case for the word will send the models to the bottom of the listing

Open the map file

Select the folder icon then select [Open]

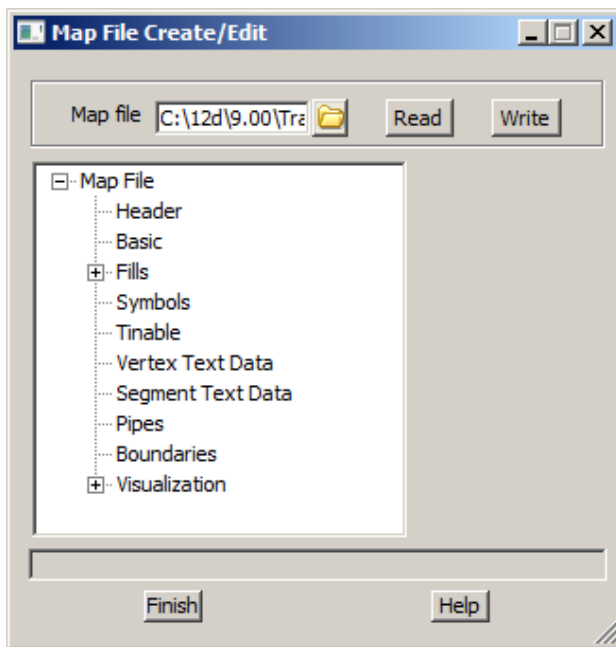
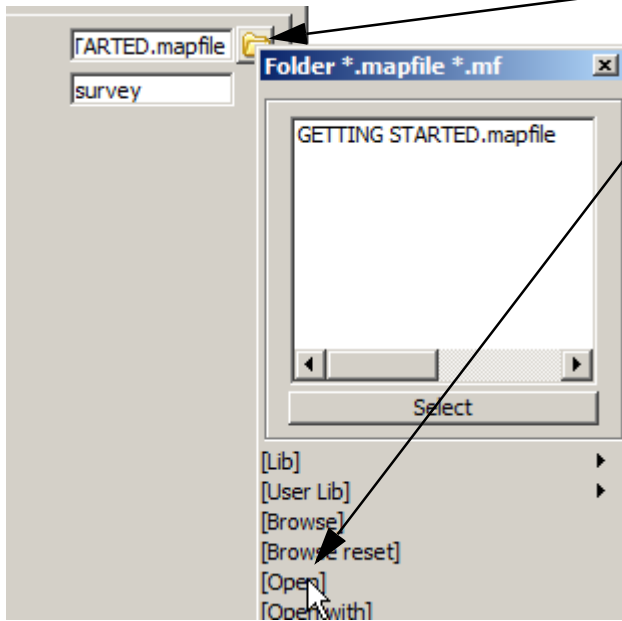

A branch structure is used to access the tabs within the map file

The Basic tab is shown below which sets the model, colour and more

	Key	Att Key	Name	Model	Colour	Point Line
1	BB		TOPO BANK BOTTOM		orange	line
2	CG		TOPO CHANGE GRADE		orange	line
3	CR		ROAD CROWN		white	line
4	DR		TOPO DRAIN CL		cyan	line
5	DTMBDY		TOPO TIN BDY		red	line
6	ES		ROAD PAVEMENT EDGE		white	line
7	SEC		SEWER PIPE		brown	line
8	SL		TOPO SURFACE LEVEL		orange	point
9	STN		SI IRVY STN		red	line

Click LB on [Finish] to exit the mapping file

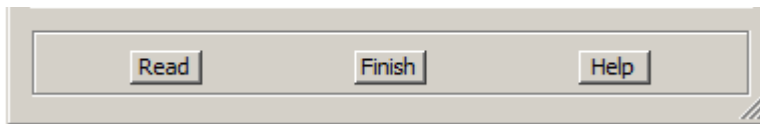

Click LB on Read to import the data file

Click LB on the Add models to view icon  to display the survey models

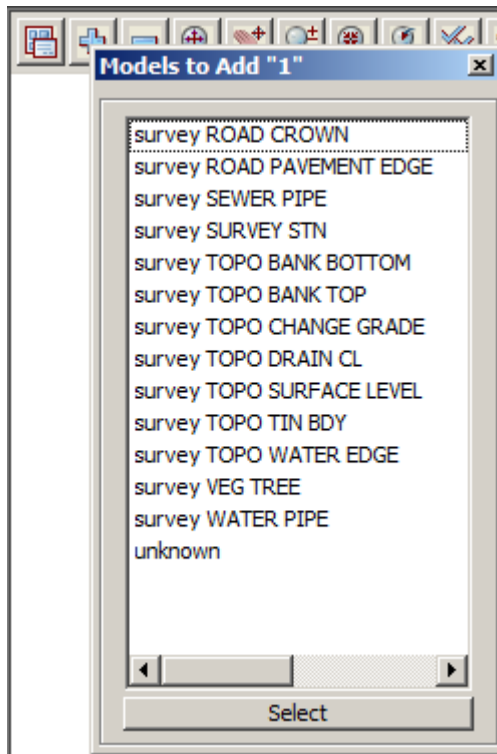

The models are listed

Click LB on *[Select]*

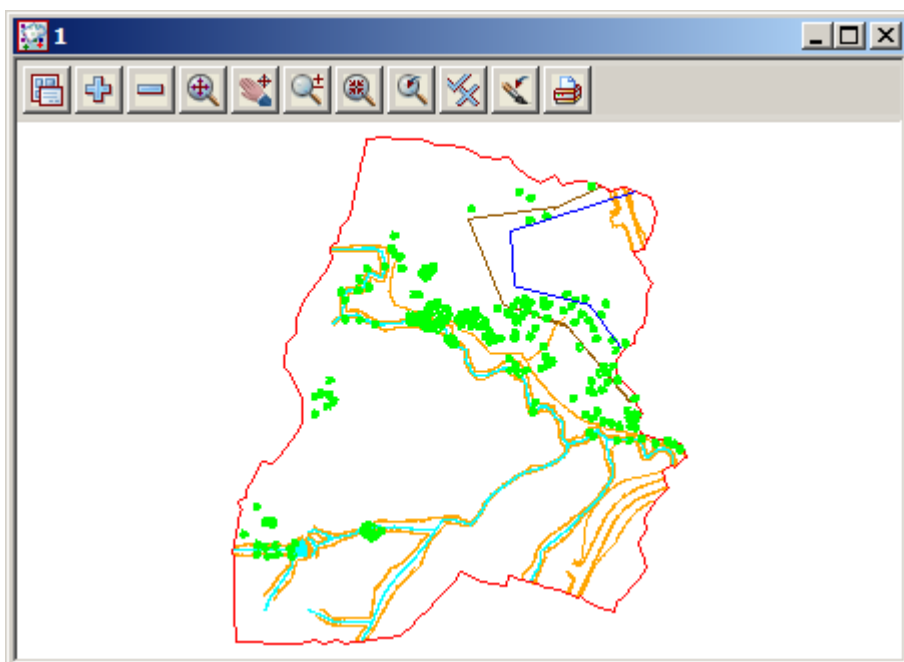

5.2 Plan View Operations

Now that we have some data, we can begin to look at some more of the Plan view features of 12d.



Menu

Bring up the Plan view Menu.



Adding/removing models



In the Plan View Button Area, you will observe a '+' and '-'. This is a shorthand technique for turning models on and off.

Click on the '-' sign button with LB. A list of available models to remove from the view pops up. Pick 'survey VEG TREE' and click LB on 'Select'. You will observe the tree symbols in model 'survey VEG TREE' are removed from the view. The '+' works in a similar way to add models to the View. Practice adding and removing models from the view with the + and -. Remember, the models are not being deleted with the '-', merely removed from the current View. Turn back on the tree model 'survey VEG TREE'.



Fit

After multiple pans and zooms, you sometimes wish to return to a point where all of your data appears in the view. This is equivalent to an AutoCAD Zoom-Extents. Click on Fit with LB to see all of your data.



Dynamic Pan

This facility allows you to move the centre of the view but retain the current zoom factor. Click on Pan with LB. You then press down LB on a point in the View and then drag the mouse. The data in the view will move with the mouse until LB is released.



Zoom

Select Zoom (to Zoom In) from the Plan View Button area with LB. Click LB on two diagonal points of a rectangle and then click LB once anywhere in the plan view. The information will appear enlarged based on the size of the rectangle.

MB Wheel Zoom

If your mouse has a wheel as part of the middle button, then it can be used to dynamically zoom in or out. Simply click LB in the plan view at the point you want to zoom about and then roll the wheel forward to zoom in and backwards to zoom out.



Shrink

This is equivalent to Zoom Out. It works just like Zoom but in reverse.



Previous

If you click LB on Previous, the view will appear as it was prior to the Zoom. 12d always keeps the details

of the previous view setting available so that you can return to it quickly. Only one level of previous view settings is kept.



Toggle

There are multiple items under the Toggle Pop Up menu. At this time, we will try only one of them. Select **Grid** with the LB. A rectangular grid should appear. If you click LB on **Toggle =>Grid** again, the Grid will be removed from the display.

The appearance of the grid can be changed by clicking LB on the Menu button in the View Button Area and click LB on **Settings =>Grid**. You can change any of the settings in the panel. Try changing the grid spacing from 100 to 10 in both x and y directions and click LB on **Set**. You will notice that the Grid can be turned on and off from either the panel settings or the **Toggle =>Grid** switch. Click LB on **Finish** to terminate the panel.



Refresh

All the information on the view will be redrawn. This can also be achieved by clicking MB anywhere in the *View Title Area* or anywhere in the *View Button Area* except over the '+' or '-' buttons.



Plot

Bring up the Plan view Plot Menu.

5.3 Birds-Eye Views and ‘Throwing’ Between Views

We saw in Chapter 3.10 ‘Basic View Operations’ how to create a new View. To introduce some new concepts in 12d, we need a second small Plan view on the desktop. Firstly resize your existing ‘Plan 1’ view to take up around 2/3 of the left hand side of your desktop.

From the main menu, click LB on **Views=>New=>Plan** and place a small view about 50mm square in the top right hand corner of your desktop. This will create View ‘Plan 2’. See Chapter 3.10 for full details on how to create and resize Views.

Note that when creating a View using **Views=>Create=>Plan View**, 12d pops up the ‘New Plan View’ panel. The View Name field will already have a ‘number’ in it supplied by 12d. 12d will always supply you a View number that is not currently in use. If you want, you can overwrite the number suggested by 12d provided the number you type does not currently exist (it may have been created earlier and then been deleted. It is OK to reuse a previous number).

In the View ‘Plan 2’, use the ‘+’ sign button to turn on all of the models. From the ‘Plan 2’ View Button area, click LB on **Zoom** and click a point in the lower left corner of the View ‘Plan 2’. Before selecting the second point of the Zoom rectangle, move the cursor into the other View i.e. ‘Plan 1’.

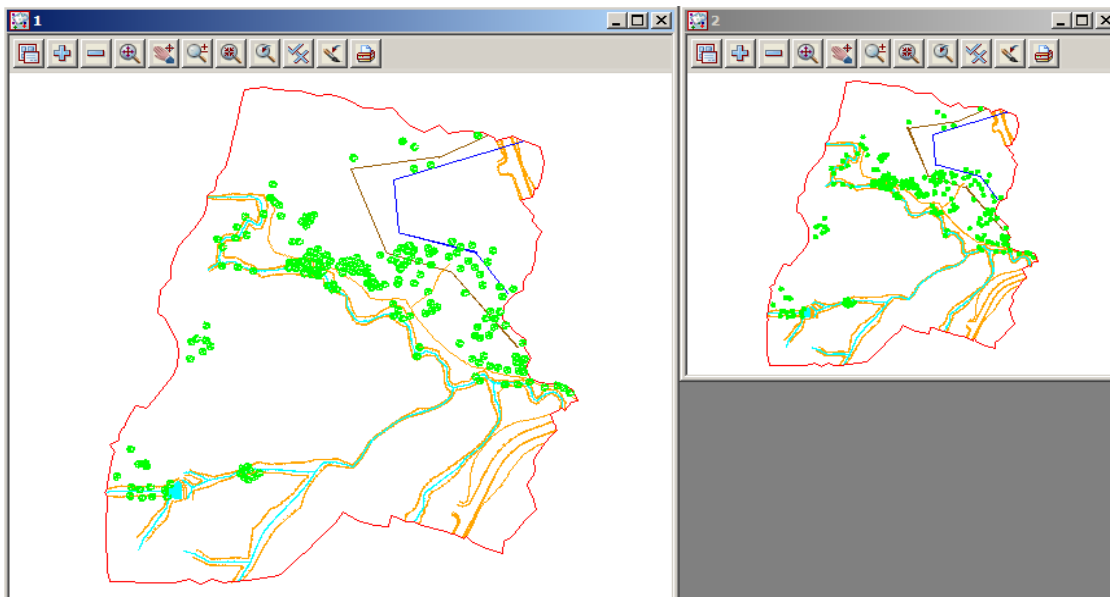

Select the second point of the Zoom rectangle in either View. After selecting the second point of the Zoom rectangle, you will notice the following prompt in the View Message Box

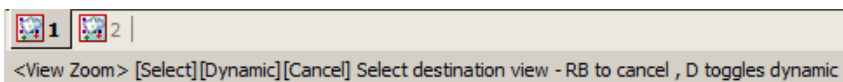

12d is prompting you to select the View you want ‘zoomed’. Click LB in View ‘Plan 1’. The zooming will then take effect in View ‘Plan 1’.

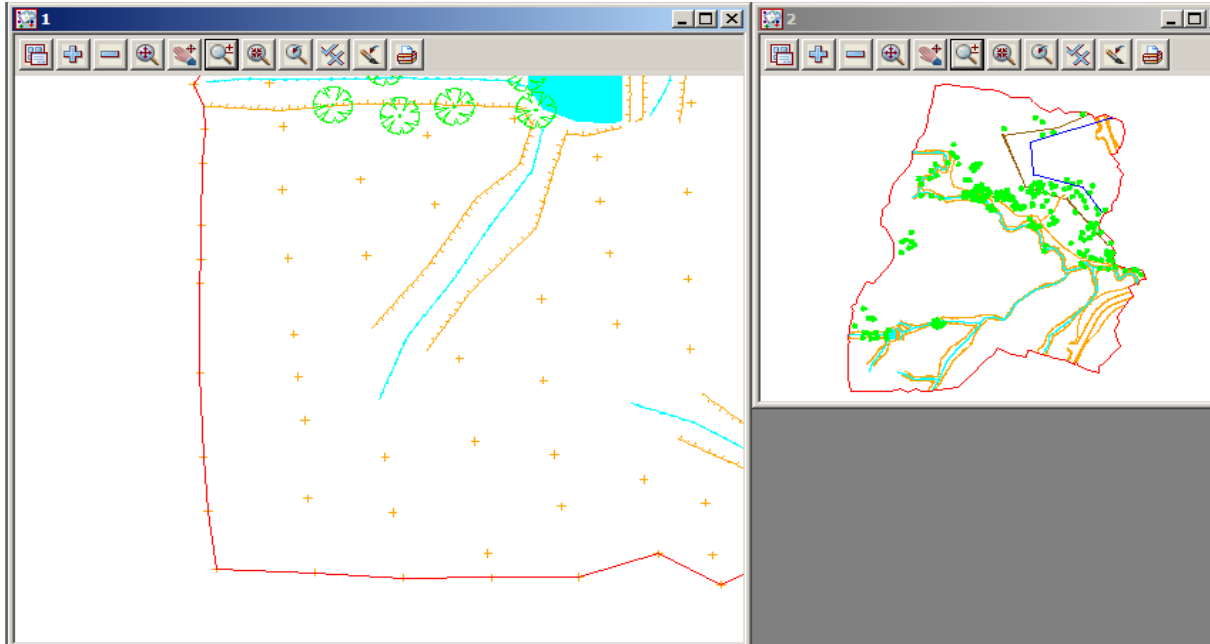

Notice that using this technique, it is possible to achieve a birds-eye effect where the smaller View displays the complete model whilst the larger 'working' view is zoomed to an extent where it displays only the detail that you are currently working on. You would typically do all of your zooming in View 'Plan 2' but have the detail updated in View 'Plan 1'. You could even do this with different models turned on. In the birds-eye view, you would typically only turn on sufficient detail to enable you to zoom on known features.

It is suggested you practice zooming and throwing between Views as this is a powerful concept in 12d and you should feel comfortable at using it.

After completing this exercise, delete View 'Plan 2' as it is no longer needed. You will now see a second way to delete a View. Click LB in the View Menu button in the View Button Area of 'Plan 2' and select **Delete** and **Yes** to confirm the deletion. The Delete View menu can also be brought up by clicking LB on the Menu button in the View Button Area of the View you wish to delete and select **Delete** and **Yes** to confirm the deletion.

It is suggested that you maximise 'Plan 1'.

5.4 Deleting a Model

As we now wish to look at an alternative (and preferred) way of importing data into 12d, we will delete the existing models as they will be recreated in the following option.

From the Main menu, click with LB on **Models=>Delete=>Delete all models**

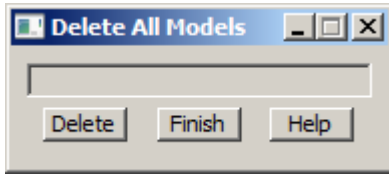

Click LB on **Delete**

Click LB on **Yes** to confirm

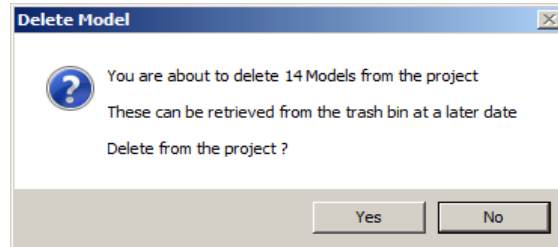

When models are deleted they are sent to the **Trash Bin** in case they need to be restored at a later stage. A trash bin icon appears at the bottom right of the 12d screen

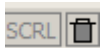

To access the deleted models double click LB on the icon or select **Project=>Management=>Trash Bin**

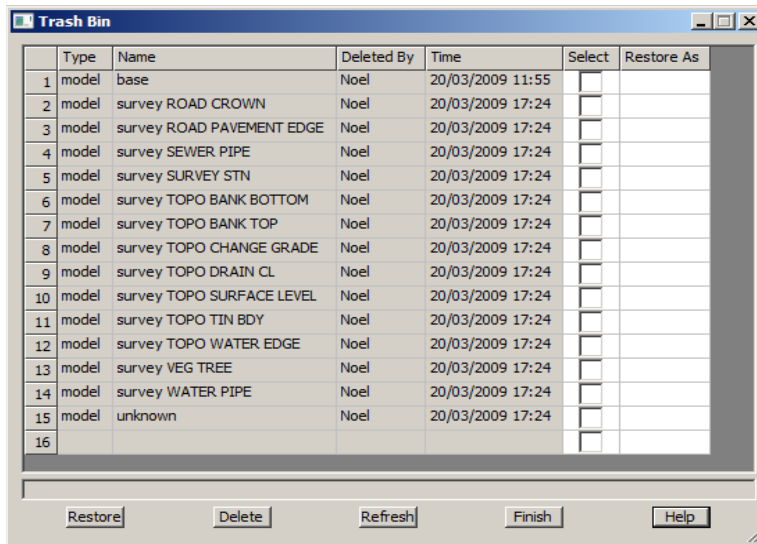

To restore a model click LB next to the model under the **Select** column then click LB on **[Restore]**

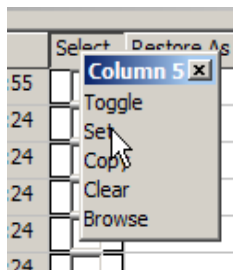

To delete all models in the trash bin (like emptying the Windows Recycle Bin) highlight all of the models by clicking LB then RB over the top of the select column. Click LB on **Set** to highlight the models and click LB on **[Delete]**

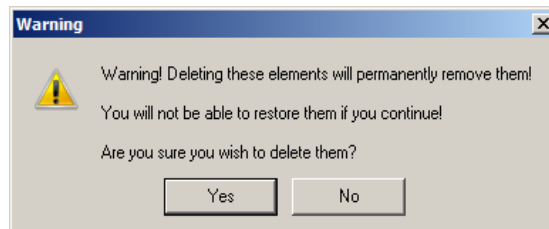

Click LB on **[Yes]** to confirm deleting the models

5.7 Saving a Project

The changes to the Project you are working on are currently only stored in memory. To make the changes permanent and update your files on disk you need to Save the Project. This can be done at any time by clicking LB on **Save** from the Projects Menu (**Project =>Save**).

12d will occasionally pop up a panel reminding you 'Do you want to save the project?'

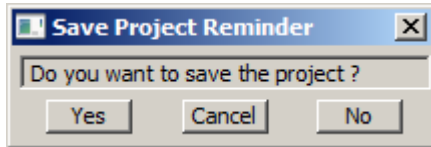

Click on **Yes** with LB to force a Save to occur.

The timing at which this message appears is set from the Main menu in **Project =>Management =>Defaults**. See the data field 'Save Interval (min)' under the 'System Settings' tab.

The default is every 15 minutes. You can set the time interval to zero to turn this feature off altogether.

If you ever crash out of 12d due to a power failure for instance, any changes since your last **Save** operation will be lost.

5.8 Exit

To terminate a 12d session, click LB on **Exit** from the Project menu (**Project =>Exit**). If you try to Exit 12d after changes have been made to your Project, 12d will remind you of the changes by prompting you for a further **Save** operation.

5.9 Restarting 12d with an Existing Project

When you restart 12d and return to an existing project, the appearance of the desktop will be just as you last left it. The number of Views, appearance of all models and user defined parameters are redisplayed using the settings that are stored with the Project data.

The next time you start 12d, the project 'Stage 1' will appear in the previous projects list.

Double clicking LB on 'STAGE 1' in the list and you will be taken into the project 'STAGE 1'.

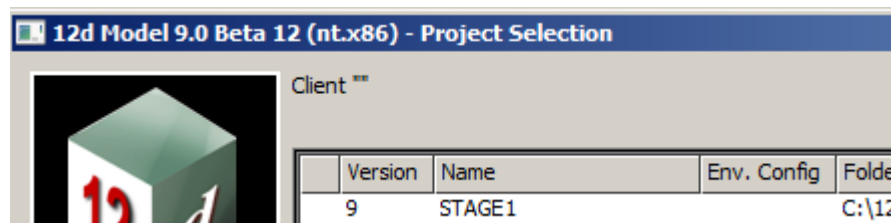

Alternatively, if you navigate to the folder containing the project 'STAGE 1', you will automatically get a pop up list of all available projects in that folder to select from.

Click LB on 'STAGE 1' to highlight it and then click LB on the **Select** button. Alternatively, you can double click on 'STAGE 1' to bypass the Select button.

If you have trouble restarting 12d, remember you called this Project 'STAGE 1'. See Chapter 3.2 to remind yourself how to start 12d.

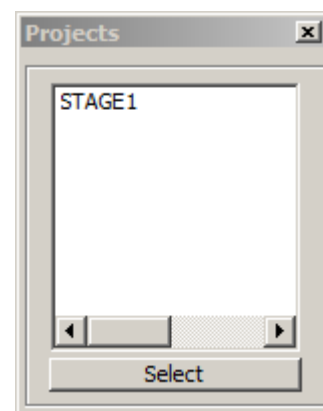

6 Basic Modelling

6.1 Alternative data entry

We will now repeat the process of importing data into 12d but this time we will use a 12d ascii file.

This option is the more common way of transferring data from Surveyor to Designer when both parties use 12d. The ascii format will often include all of the strings with the correct model, colour and other properties so that no mapping is required. Also a tin (triangulation) can be included in this file format so that the Designer has no need to create a new tin from the survey data. In this instance we will assume the coding is correct but the models are different so that mapping is required. Also a tin is not included.

We will import the file 'DETAIL SURVEY.12da'. To read in the file, click LB on **File I/O=>Data Input=>12da/4da data** from the Main menu.

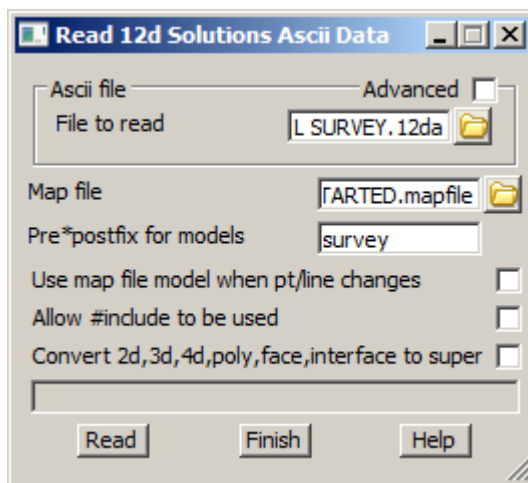

Click LB on the File folder icon then browse back up to the folder
C:\12d\9.00\Training\design\getting started basic

Click LB on the file **DETAIL SURVEY.12da**

Click LB on [Open] to select the file

Select the map file icon and again browse to the folder **C:\12d\9.00\Training\design\getting started basic**

and select the file **GETTING STARTED.mapfile**

A model prefix 'survey' is again typed in to group the survey models away from the future design models.

Click on **Read** to read the data into 12d Model.

Turn on all of the models

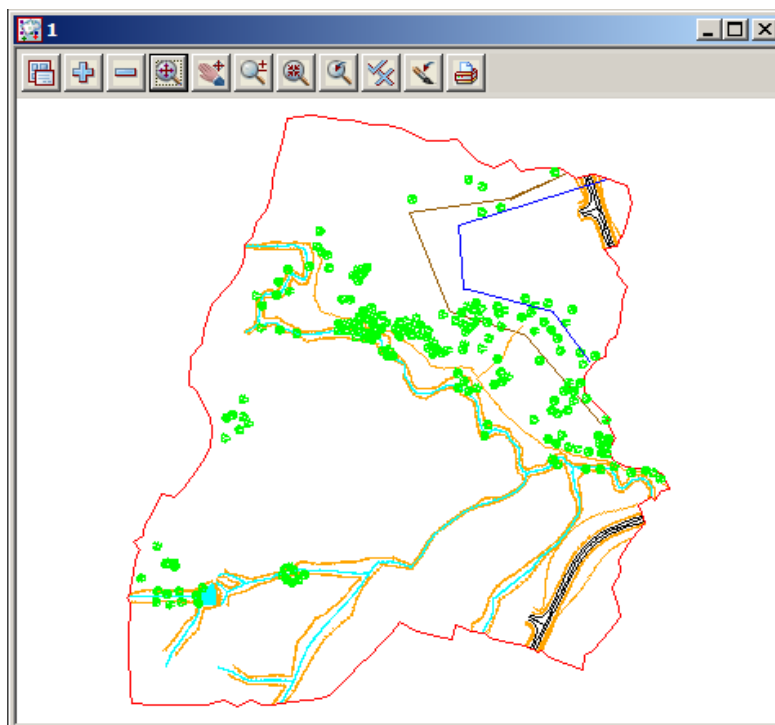

6.2 Saving model listing to a file for future use

We will now perform a function that is only meaningful later on when we are manipulating TINs. First we need to click on the 'Plan 1' view tab such that Plan View 1 is now our focus. The heading in view 'Plan 1' should appear coloured bright blue and it should be to the forefront.

The current thirteen models on the view are exactly the models that are used to create the 'natural surface' tin. We will now see how to record these models in a form that can be used in the future to restore those same models to another view.

From the Main menu click LB on **View=>Models Save/Restore**

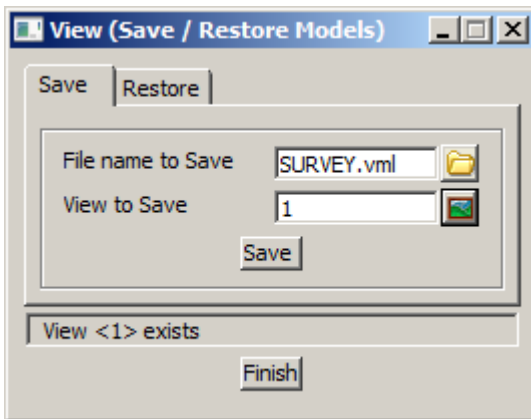

Type in the file name **SURVEY**.
Pressing [Enter] will add the extension **.vml**

Click LB on the view icon then select view **1**

Click LB on **Save**

Click LB on **Finish** to exit the panel

This file can be read at any future time by use of the Restore option. This will add the same models to a view which need not necessarily be plan view '1'.

6.3 Triangulation

We will now use this point and line information to create a 3d surface or TIN (Triangulated Irregular Network). One of the concepts in 12d is that a TIN can be created from a single Model, a single View or model list. In general, you will use Views to create models since you can control which models are on display in a View. It is important to understand that when creating a TIN from a View, only those models on display in the View will be used in creating the TIN and only then if they are set to be tinable in the map file. For instance, if you were forming a TIN to represent the natural surface, you could leave turned ON any models that represented underground surfaces prior to creating the TIN, because in the mapping file they would be set to be non tinable.

When using a mapping file to read in data, strings can be flagged as being tinable (Breaklines) or non-tinable. Only tinable strings are used in the triangulation. Breaklines are used to pick up the topographical features accurately. When forming triangles, 12d ensures that every breakline has the sides of one or more triangles along the entire breakline i.e. triangles never cross breaklines (unless the breaklines themselves cross).

In this exercise we are assuming that the survey strings have been checked for errors (See Getting started for Surveying manual)

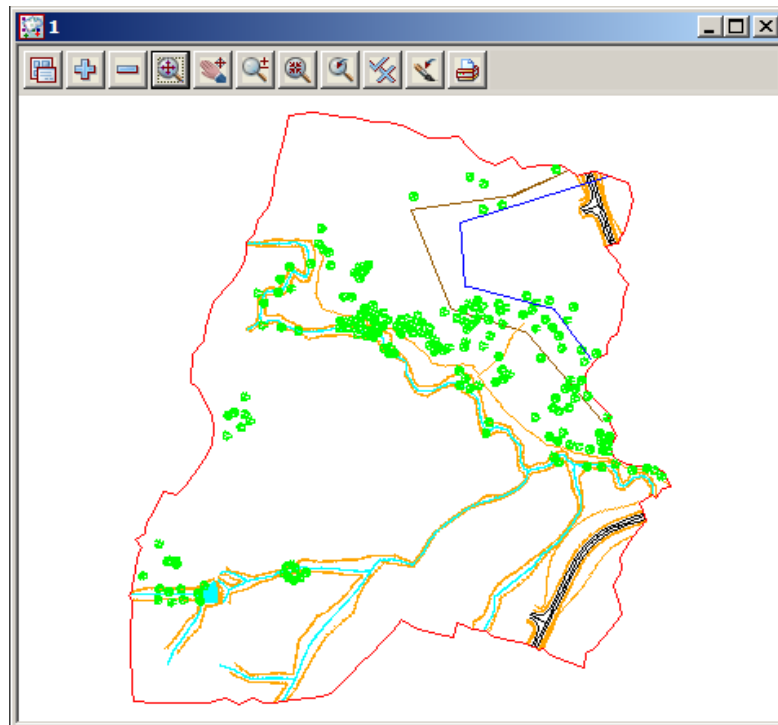

For the purposes of the ongoing tutorial, please ensure that all models in view 'Plan 1' are on display prior to creating the TIN. 'Plan 1' should look as shown above. Note that the points do not display when zoomed out.

From the Main menu, click LB on **Tins=>Create=>Triangulate data**

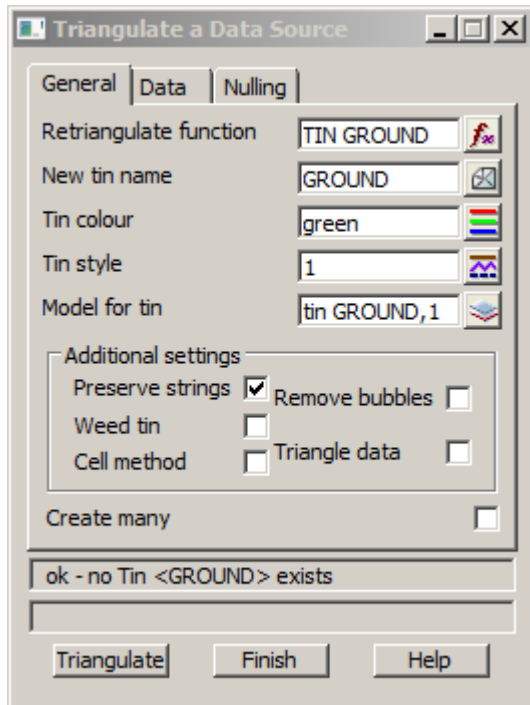

Fill in the first tab of the panel as shown.

The **Retriangulate function** option is used to construct a function which, when recalculated, will run a retriangulation on the tin. Place the cursor in the data field with the LB and type in '**TIN GROUND**'

Each TIN requires a name. Position the cursor in the **New tin name** field and type in '**GROUND**'. If you press the Enter key, this name will also be used to fill in the **Model for tin** field but with the prefix 'tin ' (see panel). The TIN name is subsequently used to refer to this specific TIN.

Position the cursor in the 'Model for Tin' field and type in the suffix '**,1**' after the name so that the model is displayed as the TIN is created. It is permissible to overwrite this name but this is not recommended.

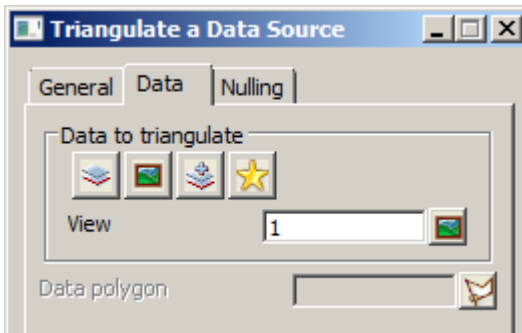

Click on the **Data** tab.

As we wish to triangulate all the data in plan view 1 and leave the tinability to determine which data to use, click LB on the view  icon. Select '1' from the list.

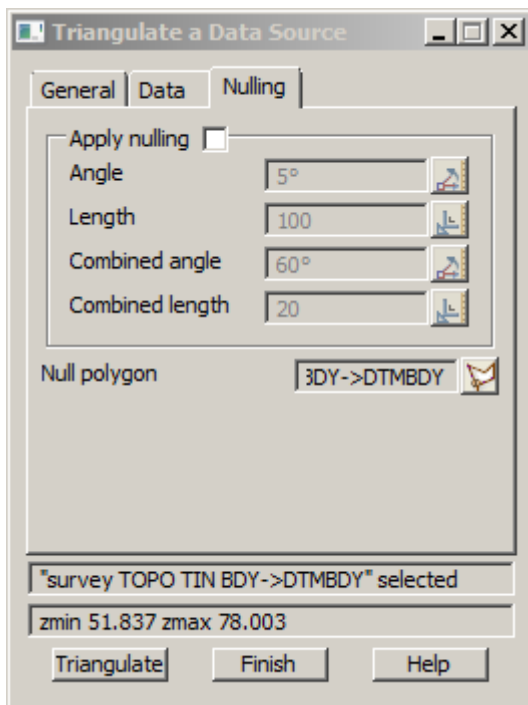

Click on the **Nulling** tab.

Click on the **Apply Nulling** check mark.

There are two options here, you can either set the parameters to null the external triangles or you can use a polygon to null all triangles outside this polygon. The **DTMBDY** string will be used as the boundary for the tin. Click LB on the **Null polygon** string icon then click LB on the **DTMBDY** string followed by clicking middle button (MB) to accept the string.

Click LB on **Triangulate** to create the TIN. There will be a short delay and then your TIN will be created and on display as shown below.

Click LB on **Finish** to terminate the panel.

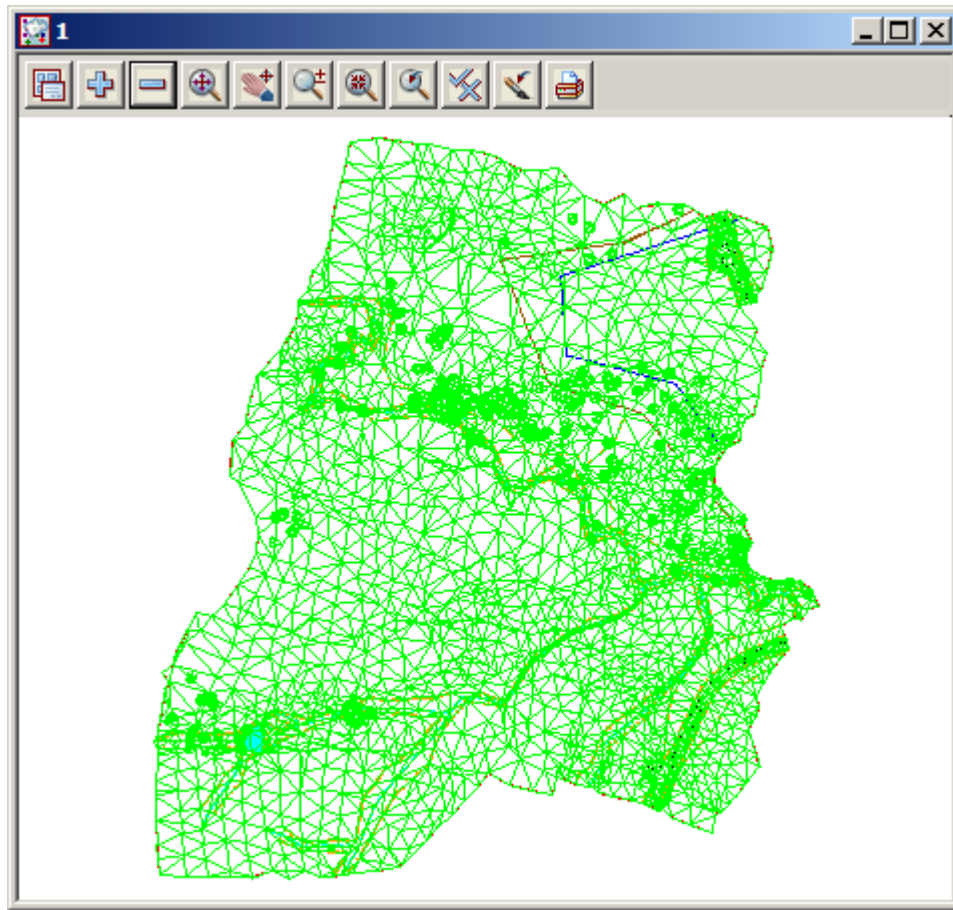

Note that the TIN is clipped at the selected null polygon ensuring only the surveyed data is included. Now that we have a TIN we can display the TIN data in a variety of ways

6.4 Tin inquire.

From the Main menu, click LB on **Tins=>Inquire** and the Tin Inquire panel pops up.

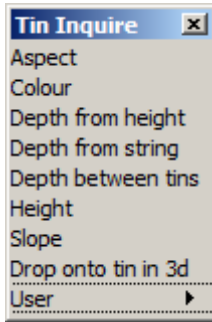

Click LB in the menu title area (where it says Tin Inquire), move the menu and Pin it with the LB. This operation is necessary to stop the menu from collapsing after the first menu pick.

Click LB on **Aspect**, and the Tin Aspect Inquire panel will pop up.

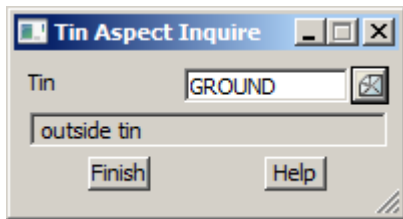

Move the cursor over the *Tin* icon button at right end of the 'Tin' field and use the LB to pop up a list of Tins. Double click LB on **GROUND**. Then click LB in the menu title area (where it says Tin Aspect Inquire), move the panel to a clear area of your screen and pin it with the LB. Do not Click on the Finish button in the panel.

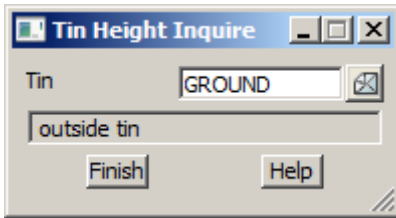

Repeat this procedure with both the **Height** and **Slope** menu items.

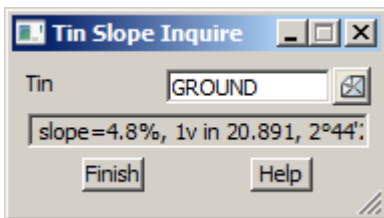

Once all three panels are on the screen, move the cursor anywhere over the TIN and observe what happens. When the cursor is positioned over any one triangle, the three point coordinates of the triangle are being used to linearly interpolate 'on the fly' to calculate the exact x,y,z coordinates of the cursor. Also the aspect and slope of the triangle is shown in the respective panels.

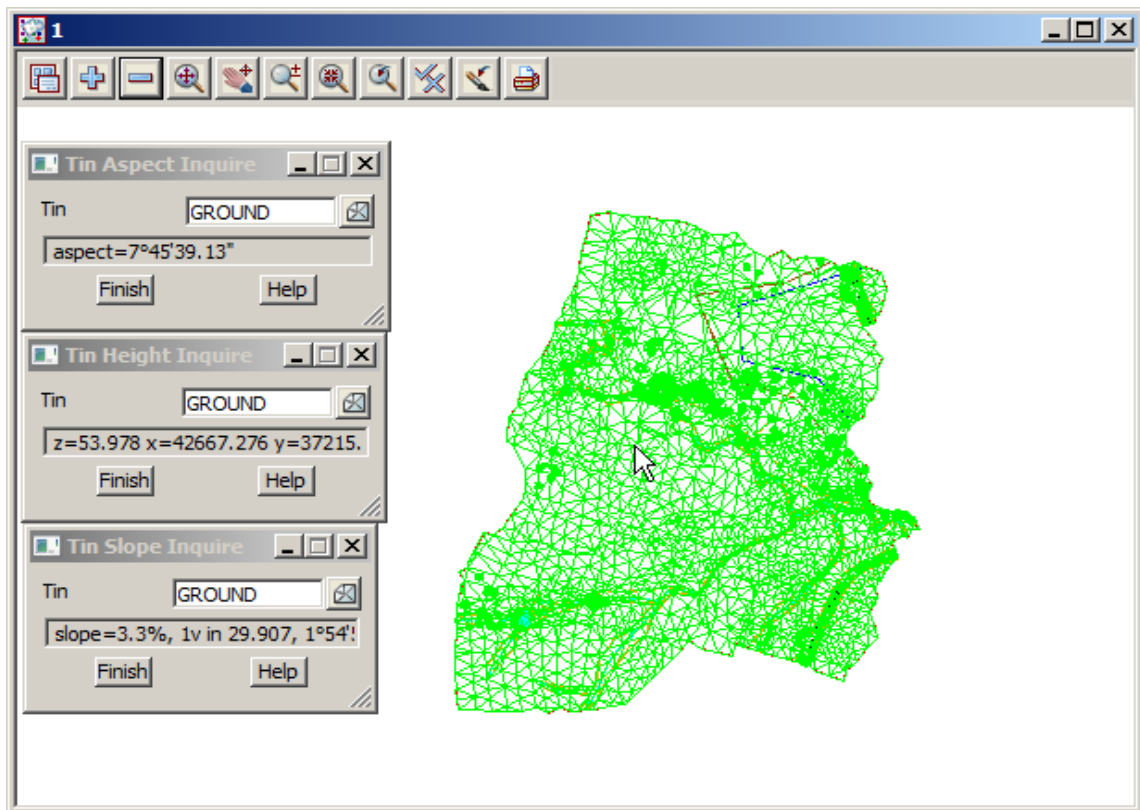

Click LB on **Finish** on all three panels to put them away. Also click LB on '**X**' on the Tin Inquire menu to shut it down.

We will now look at the various ways information in TINs can be viewed.

6.5 'Fast' Contours

We now want to remove all of the models from the View except 'tin GROUND'. From the View menu (in the View Button area), click LB on the '-' sign to pop up the Models to Remove panel.

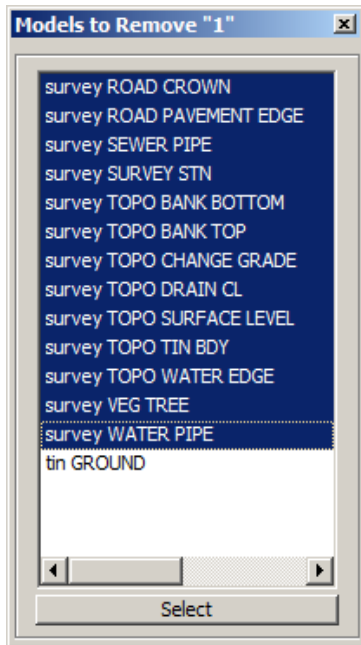

Click LB in the panel title area (over the words Models to Remove), move the panel and repin it with LB so that it doesn't collapse after each selection.

Now click the LB on the first survey model. Drag the mouse down the list to highlight all the survey models and click on 'Select'. Alternatively, you could double click LB on each model in turn *except* 'tin GROUND'. Click LB on 'X' to shut down the panel.

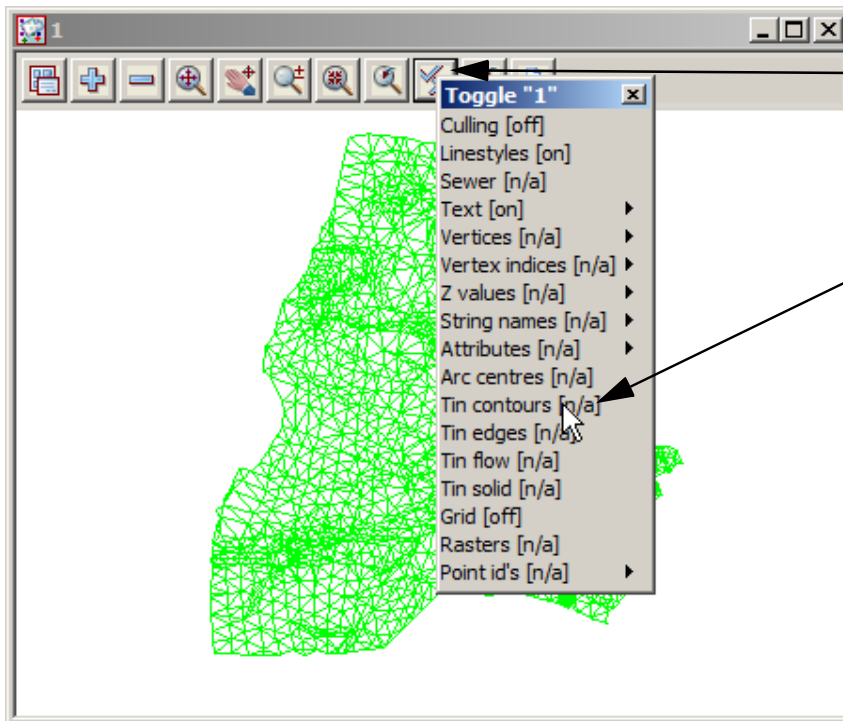

Now from the View buttons, click LB on the **Toggle** button to bring up the Toggle menu.

Then click LB on **Tin contours**. You should see the following red and green contour lines appear.

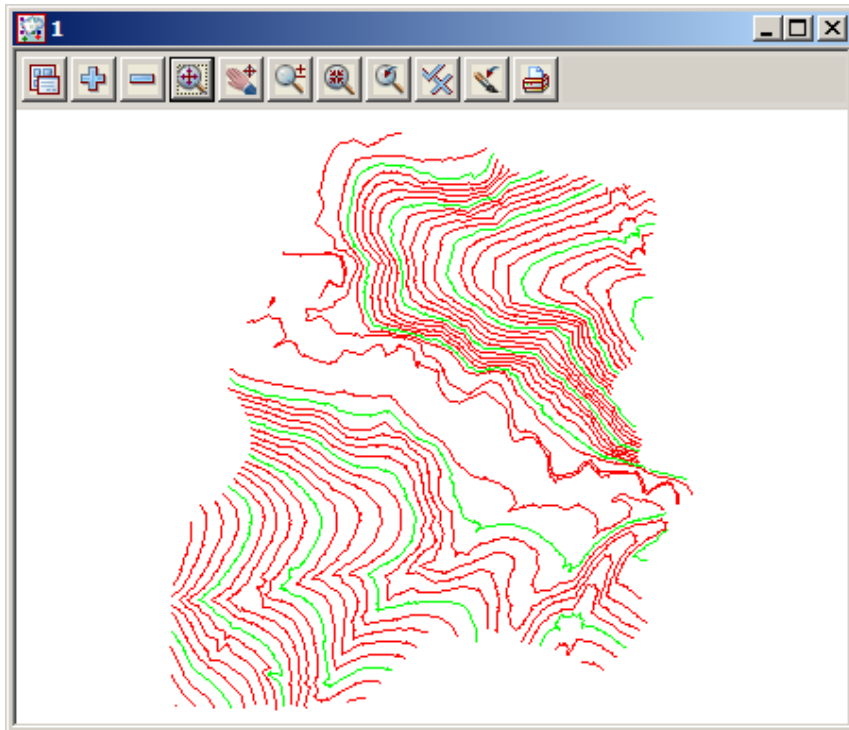

If you click **Toggle=>Tin contours** again, the View will revert to the 'green triangle' display.

The appearance of the contours can be changed by clicking LB on the Menu button in the View Button Area. Click LB on **Settings=>Tins=>Contours** and the following panel will pop up.

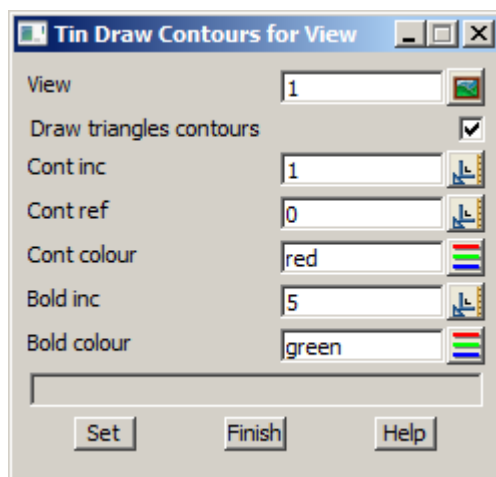

You can change any of the settings in the panel including colour. Click LB on the colour icon at the right end of the contour colour field to see a popup list of available colours. Select one by double clicking LB.

Try changing the contour increment (spacing) from 1 to 5 and the bold increment from 5 to 1 to 5. Click LB on **Set** to activate the changes. You will notice that the 'Fast' contours can be turned on and off from either the 'Draw triangles contours' tick box panel setting or the **Toggle=>Tin Contours** switch.

At the completion of experimenting it is suggested that you put the settings back to their default values (as above) at this time.

Click LB on **Finish** to terminate the panel. Your new settings will remain in effect indefinitely until changed.

6.6 'Fast' Flow Arrows

It is recommended that you turn on the drainage models for this exercise. From the View menu (in the View Button area), click LB on the '+' sign button and double click LB on 'survey TOPO BANK BOTTOM', 'survey TOPO BANK TOP' and 'survey TOPO DRAIN CL'. Make sure that the 'tin GROUND' model is also still turned on. The easiest way to confirm this is click LB on the '-' sign button in the View Button Area and look at the list of the models that could be turned off. Click LB on the 'X' button to terminate the list.

Now from the View menu, click LB on **Toggle=>Tin contours** then **Toggle=>Tin edges**. The purpose of this is to outline each triangle. Then click LB on **Toggle=>Tin flow**. You should now see an arrow appear at the centre of each triangle representing the direction of water flow.

Try zooming in on a section of the model for a closer look. When you have finished zooming, click on **Fit** to again fill the View window.

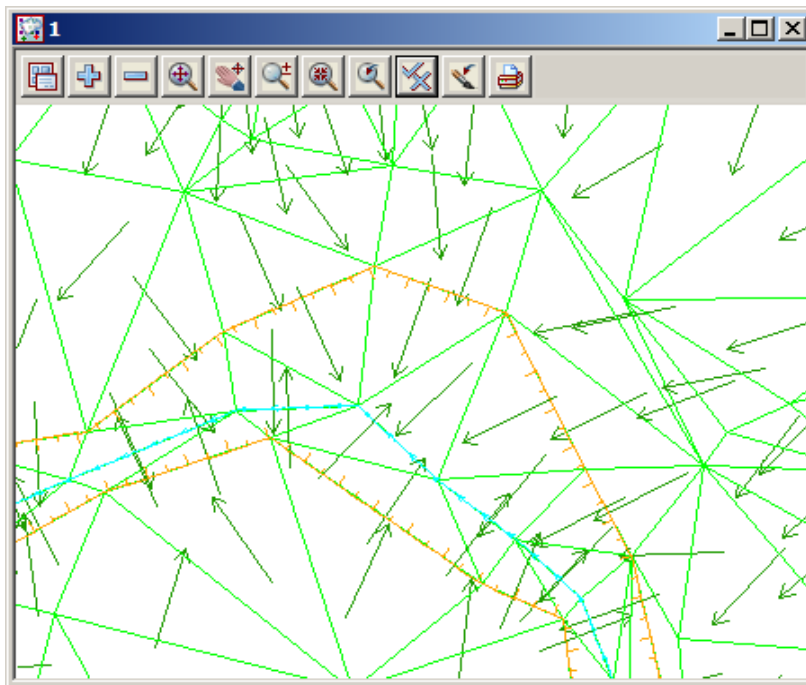

The appearance of the flow arrows can be changed by clicking LB on the Menu button in the View Button Area. Click LB on **Settings=>Tins=>Flow Arrows** and the following panel will pop up.

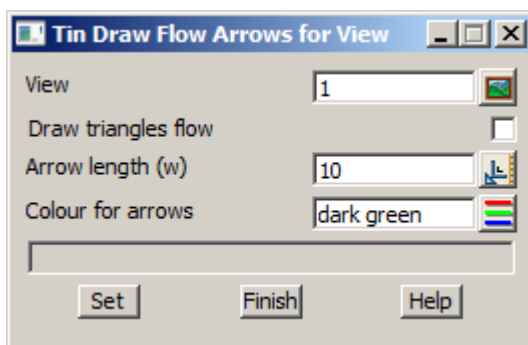

You can change the size of the arrow heads and their colour. Click LB on the colour icon for the 'Colour for arrows' field to popup a list of available colours. Select one by double clicking LB.

Try changing the arrow length from 10 to 5 world coordinates (in this case metres).

Click LB on **Set** to activate the changes. You will notice that the Flow arrows can be turned on and off from either the 'Draw triangles flow' tick box panel setting or the **Toggle=>Tin Flow** switch.

Click LB on **Finish** to terminate the panel. Your new settings will remain in effect indefinitely until changed (for this project only).

Click both **Toggle=>Tin edges** and **Toggle=>Tin flow** again and the View will revert to the 'green triangle' display.

6.7 Perspective View

We will now look at the perspective view facilities in 12d to examine the surface we created above.

Create a new perspective view. Click LB on **Views=>New=>Perspective OpenGL** from the Main menu and a new view pops up. Alternatively by selecting **Views=>Create=>Perspective OpenGL view** from the Main menu, a panel pops up.

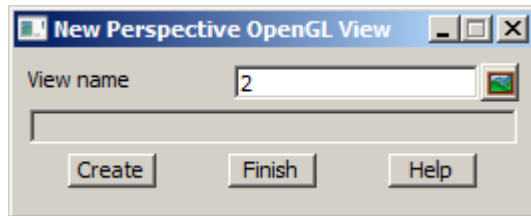

If necessary, put the cursor in the View name field, backspace over the existing entry (or use the Delete key) and type '2'.

Click LB on **Create**.

Note the new view is created immediately and is placed over the top of your existing windows.

You should use the standard windows features to 'Tile' the views. Click in the view title area for 'plan view 1' then select **Windows=>Tile Vertical**

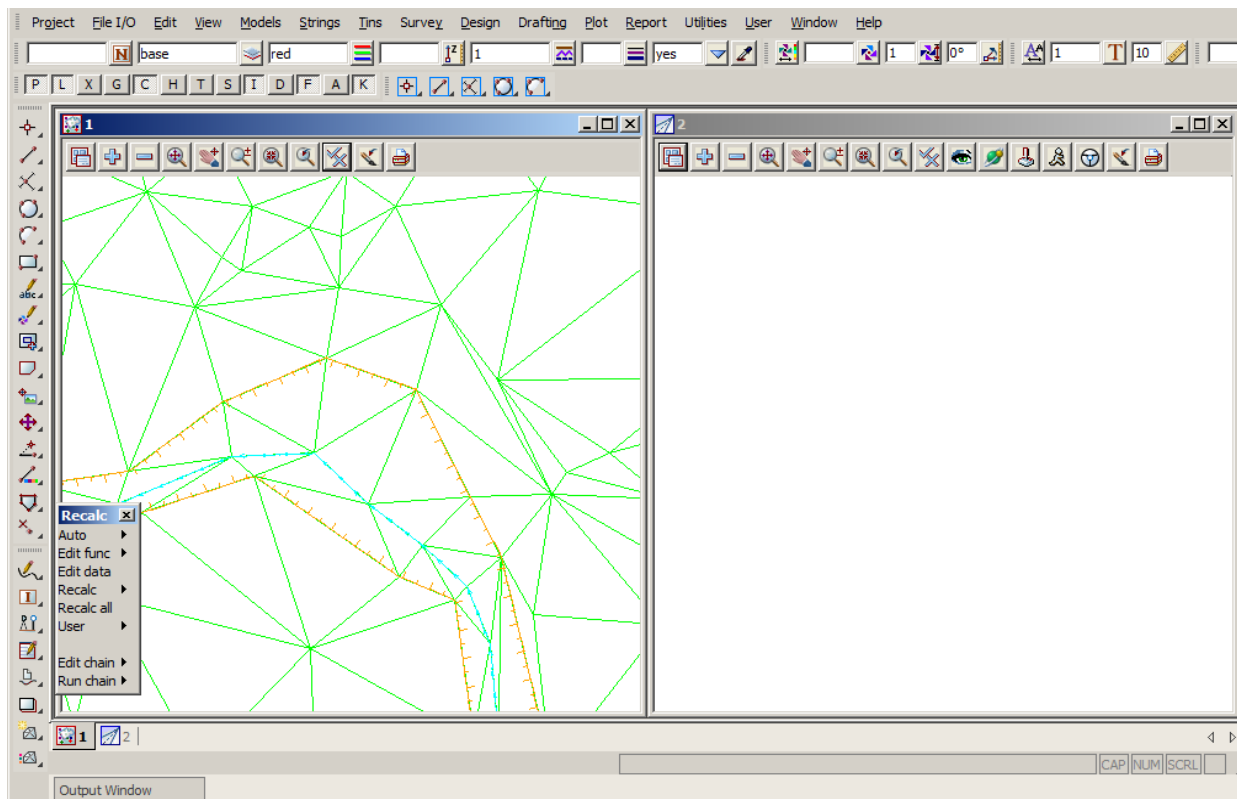

Your overall screen layout should now look something like this.

The view buttons on the Perspective view are:

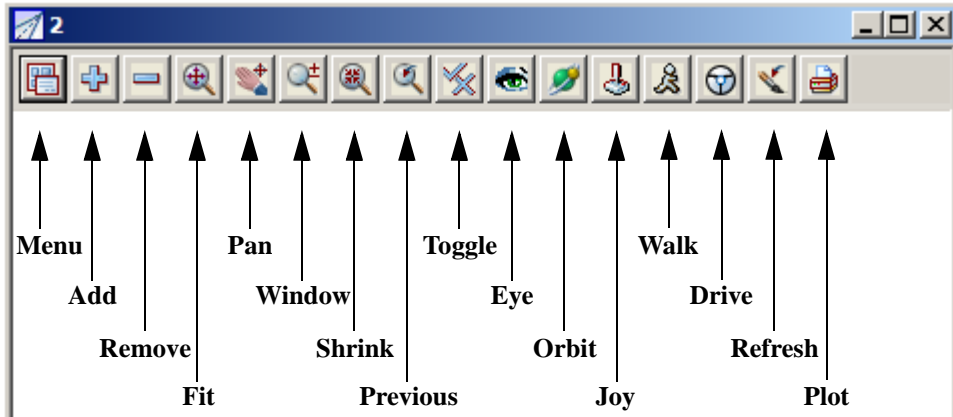

We now need to add the TIN to the perspective view. In the View Button Area of 'Perspective 2', click LB on the '+' sign button and double click LB on **tin GROUND**. Click LB on the **Fit** icon. Your Perspective view should now look as follows

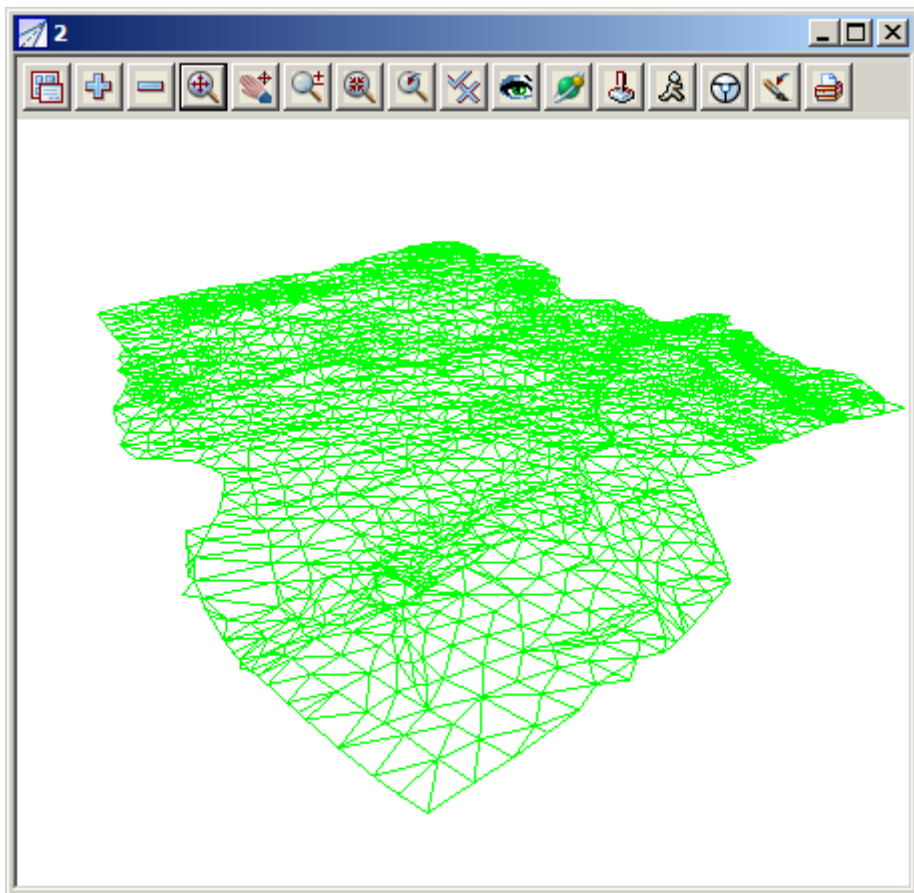

6.8 Joy Panel

The Joy (short for Joystick) provides a quick way of orientating your eye in relation to your data when manipulating a Perspective view.

The Joy panel is accessed from the View Buttons Area. Click LB on the *Joy* button in the View Button Area of 'Perspective OpenGL 2' and the **Joy View** panel appears.

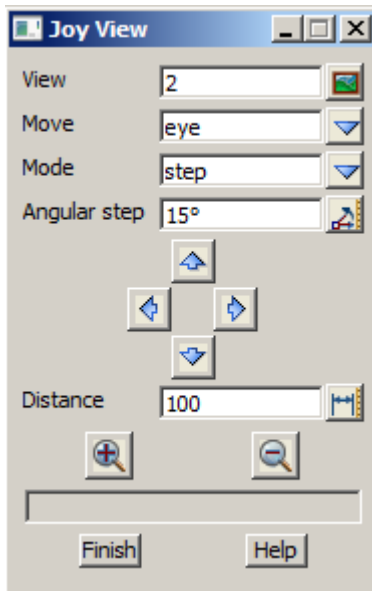

Try clicking LB on **In** and **Out** icons



and observe what is happening. Your eye is moving inwards or outwards from the data.

Also try **Up**, **Down**, **Left** and **Right** icons



If you get lost or zoom in too far, you can always start again by clicking LB on **Fit** in the View Button Area.

The angular step between each up or down step defaults to 15 degrees. You can change this if you want smaller increments by entering a new value in the Angular Step field.

Similarly, the Distance changed on each In/Out movement defaults to 100 (metres in our case as all data is in metres).

The easiest way to reset a view so that you can see all of the data is to click LB on **Fit** from the View Button Area.

6.9 Orbit Panel

The Orbit is another way to orient your eye in relation to your data when manipulating a Perspective view. The Orbit panel is accessed from the View Buttons Area. Click LB on the *Orbit* button in the View Button Area of 'Perspective OpenGL 2' and the **Orbit** panel appears.

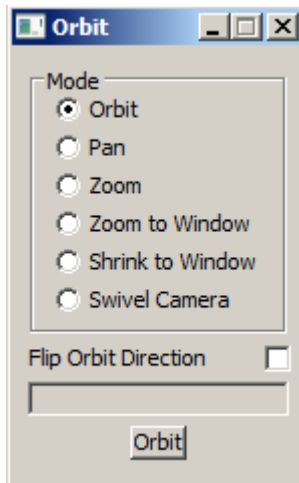

With the 'Orbit' radio button selected use the LB to rotate the image in the perspective view.

You can use the middle button wheel at the same time to zoom in and out in the perspective view

If you get lost or zoom in too far, you can always start again by clicking LB on **Fit** in the View Button Area.

The easiest way to reset a view so that you can see all of the data is to click LB on **Fit** from the View Button Area.

6.10 'Fast' Meshes in Perspective view

We will now see how to quickly display the TIN in mesh form.

From the Perspective View menu, click LB on **Toggle=>Tin mesh**. You should see a coarse rectangular grid of red and green mesh lines appear.

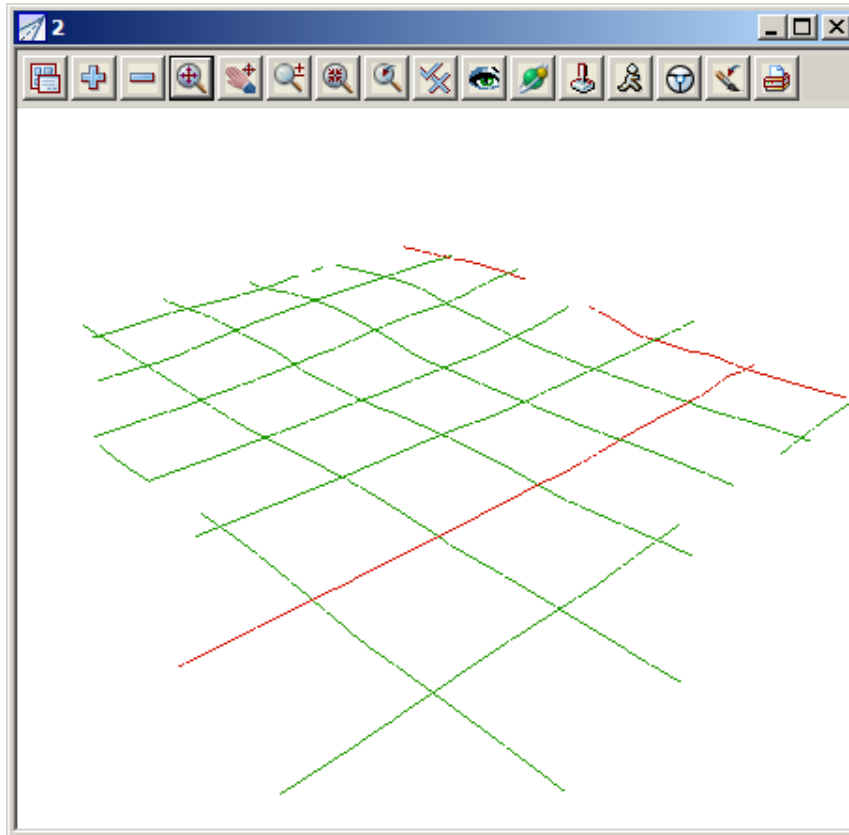

The appearance of the mesh can be improved by reducing the mesh spacing. Click LB on the Menu button in the View Button Area of the 'Perspective OpenGL 2' view and then click LB on **Settings=>Tins=>Mesh**. The following panel will pop up.

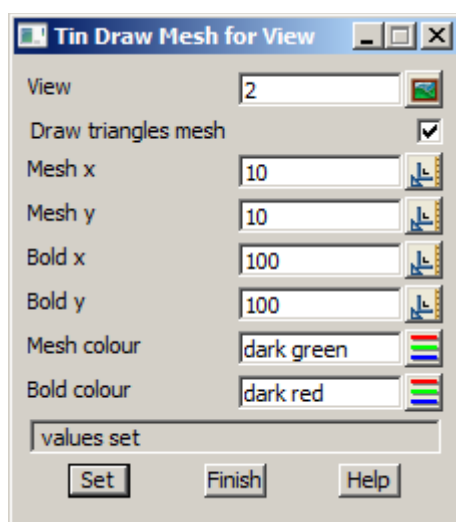

Change the settings to those shown in the panel. Change the mesh spacing from 100 to 10 in both x and y directions and bold x and y spacing from 1000 to 100. Click LB on **Set** to activate the settings.

You will notice that the Mesh can be turned ON and OFF from either the 'Draw triangles mesh' tick box in the panel or from the View menu via the **Toggle=>Tin Mesh** switch.

Click LB on **Finish** to terminate the Mesh settings panel.

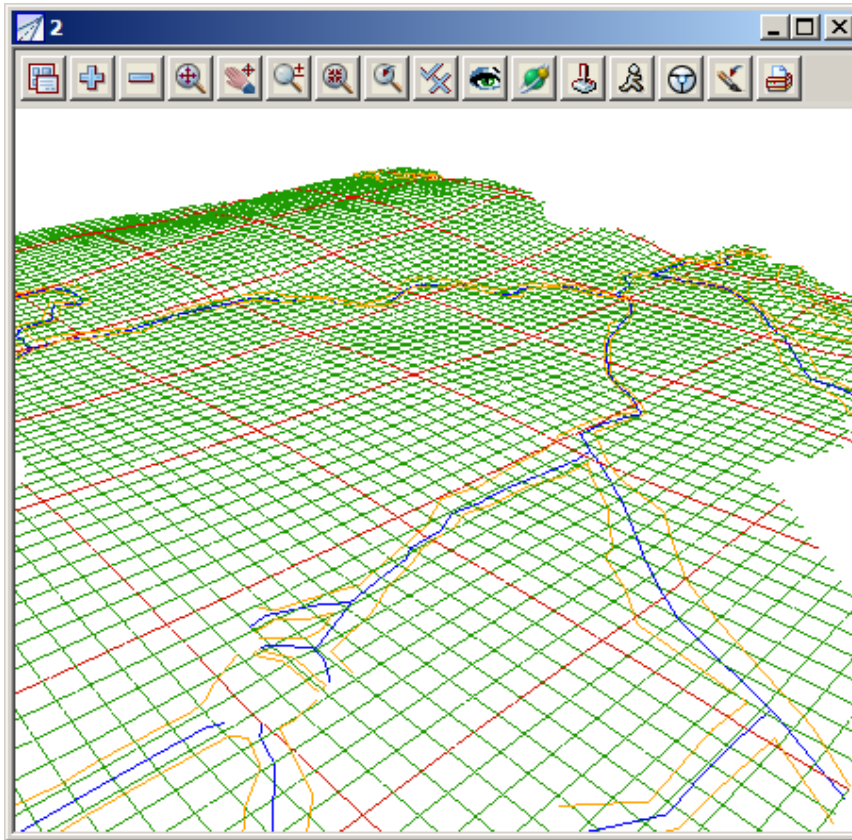

The effect of the creeks superimposed on the TIN (shown above) is created by turning on the Drainage models. Click LB on the '+' sign button in the View Button Area and double click LB on 'survey TOPO BANK BOTTOM', 'survey TOPO BANK TOP' and 'survey TOPO DRAIN CL'.

Note that 12d always displays the models in the order that they are turned on with the '+' and '-' buttons. Thus to get the effect of survey DRAIN CL (and any other models) superimposed on your TIN, you first turn all models off, then turn the TIN on first and then any other models to be superimposed last. Note that clicking LB on the Menu button in the View Button Area for 'Perspective OpenGL 2' and selecting **Models=>Remove all models** is a fast way to turn all models off.

The above perspective view orientation will stay as set indefinitely unless changed by further Joy or equivalent perspective view operations.

Toggle off the tin mesh from the View menu via the **Toggle=>Tin Mesh** switch.

6.11 Contours in Perspective Views

Sometimes it is useful to display contours in perspective views. You do this from the Toggle button. Simply click LB on **Toggle=>Tin Contours** as before.

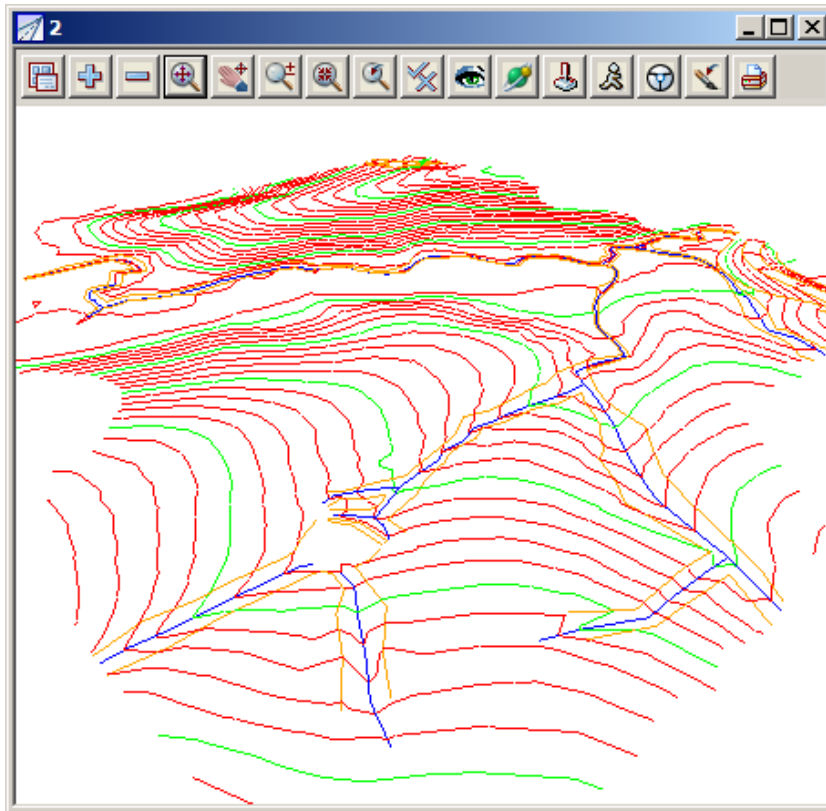

The contour spacing and colours of the Perspective view can be changed just as we did before in the Plan view. This time however you would click LB on the Menu button in the View Button Area of the 'Perspective Open GL 2' view. As before then click LB on **Settings=>Tins=>Contours**. See Chapter 6.5 for more details.

Click **Toggle=>Tin contours** again to revert to the 'green triangles' display.

6.12 Shaded Views

It is also useful to view a perspective as a colour shaded view. 12d has the ability to define up to 10,000 colours and use these to create a flat shaded view. During the shade, 12d will find and use the 'colours.12d' file supplied with the tutorial. The angle that each triangle makes with the sun (a point light source at infinity) is used to click LB on a different shade of green. The angle of the Sun can be varied but 45 degrees (the default) gives the maximum contrast.

To quickly shade all the TINs on the perspective view, simply click LB on **Toggle=>Shade**.

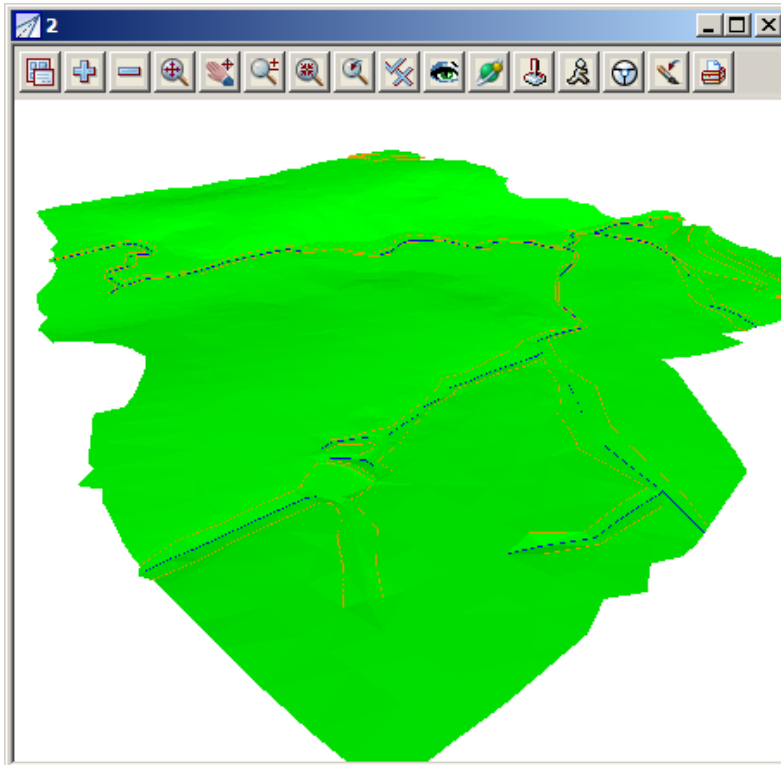

To access the Shade View panel to modify the shade settings, click LB on the Menu button in the View Button Area of 'Perspective OpenGL 2' and then click LB on **Settings=>Shade**.

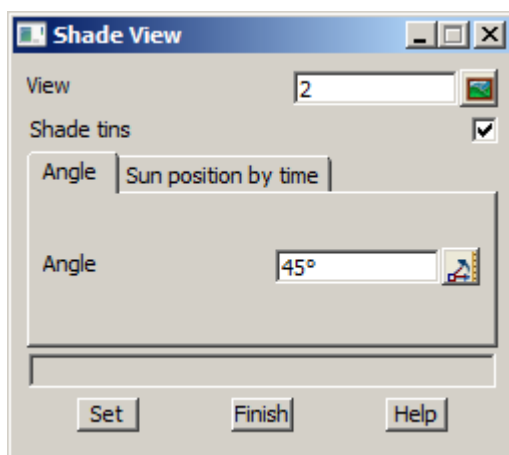

Clicking LB in the 'Shade tins' field tick box will toggle on or off the shading. A tick indicates the shade is activated.

Click LB on Set to create the shaded view. All TINs in the view will be shaded using the faces in order furthest to nearest the viewer. This has the effect of removing faces that are hidden from view.

Click LB on **Finish** to terminate the panel.

Now every time the view is refreshed or the view changed, the shaded view will reappear.

To get back to a 'green triangles' rather than a shaded view, click LB on **Toggle=>Shade** to toggle the shade off.

7 String Picking Concepts

We will now investigate picking concepts and how the mouse is used to interact with 12d when pointing to and selecting items on your screen. Initially, do all picking (i.e. mouse clicking) with the LB. This uses the 12d Model Tentative pick. Later we will look at Fast picking using MB.

In plan view '1' turn on all the models except the triangulation (tin GROUND).

Zoom in to the left dam. Your overall screen layout including the 'Plan 1' view should now look as shown below.

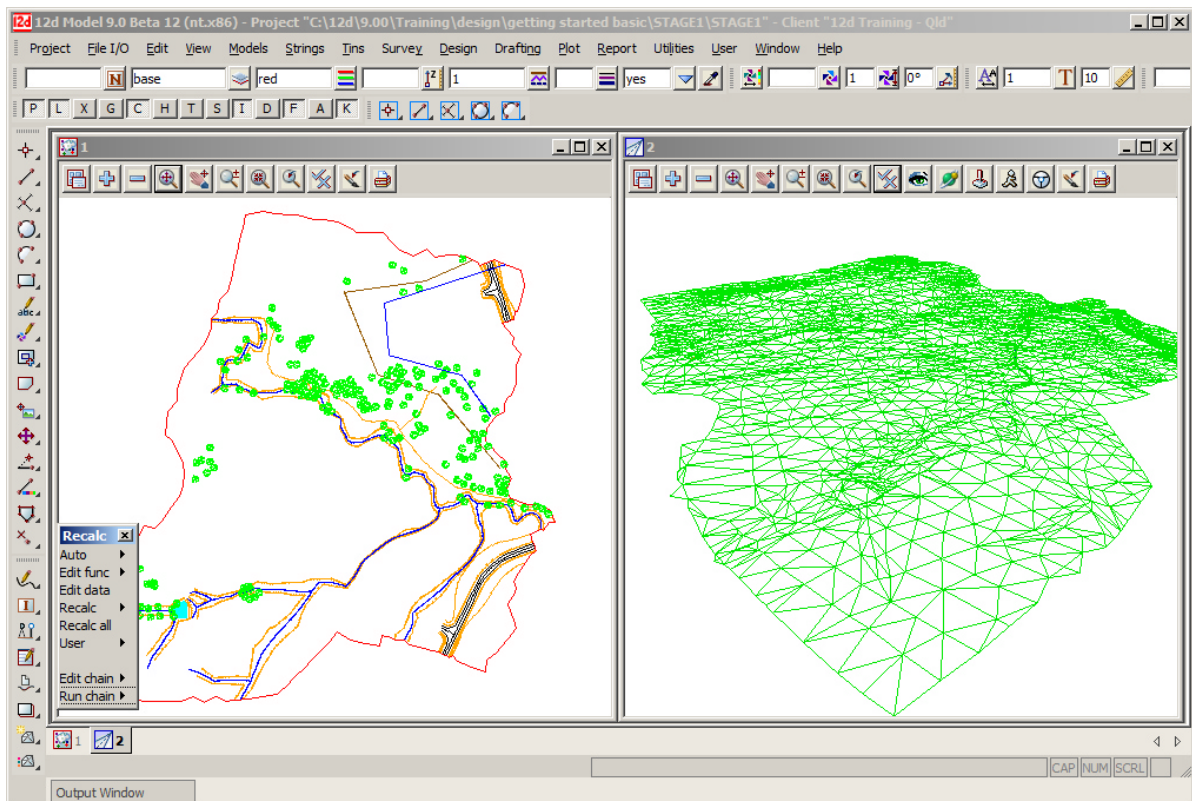

Whilst the 'string picking' concepts are used throughout 12d, especially during construction of design features where we want to connect into existing geometry, we will learn about them by example through the relatively simple 'String Inquire' feature.

7.1 String Inquire

String Inquire is used to inquire and view the details of a typical line (i.e. string) that is already present in the View. From the Main menu, click LB on **Strings=>Inquire** to bring up the following panel.

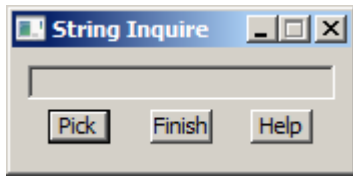

Click LB on **Pick** and then move the cursor anywhere over one of the bank strings and click LB.

NOTE: the *String Inquire* panel can also be brought up by pressing the F2 key. This has been defined in the standard 12d Model function key short cuts (userkeys.4d).

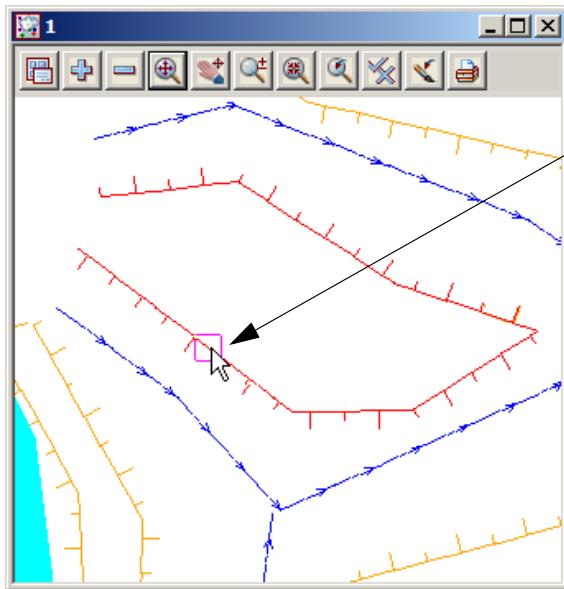

If you placed the cursor over a line:

If your Snap settings are still set to their default values, you should see the line go white (shown here as red) and a yellow (shown magenta) square box appear at the last location of your cursor when you clicked LB.

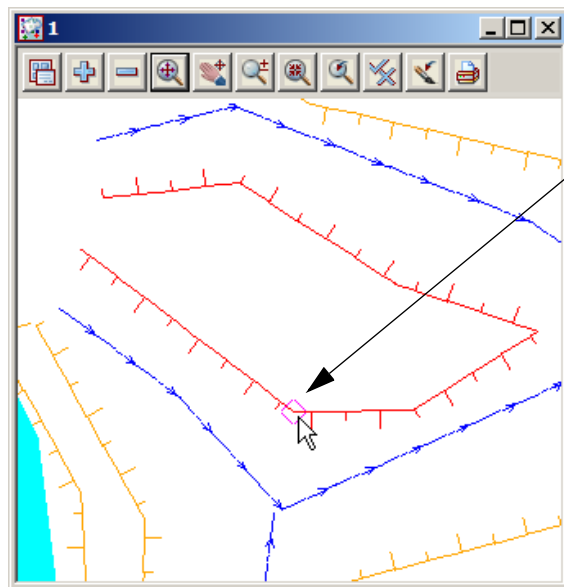

If you placed the cursor over a point connecting the line segments:

If you happened to snap to a point on the line rather than the line itself, you will see the line go white (shown red) and a yellow (shown magenta) diamond appear at the last location of the cursor when you clicked LB.

In either case, an Information panel will pop up as shown at right (provided the Info tickbox is set ON - see Chapter 7.4 'Snap Settings'). It advises such information as the name of the Model which contains the selected string (survey TOPO BANK TOP), the string name (TBR), the type of string (Super). The colour, line style and number of points in the line are also returned along with it's length.

The x and y coordinates are those of the cursor at the time of the string 'pick'.

In this case the panel shows that the string was accessed via a 'Point snap'.

If you haven't moved the cursor very far and now pick with the LB again, you will notice that the Information panel changes, the string goes back to its original orange colour and the cursor is now replaced with a yellow (shown magenta) circle.

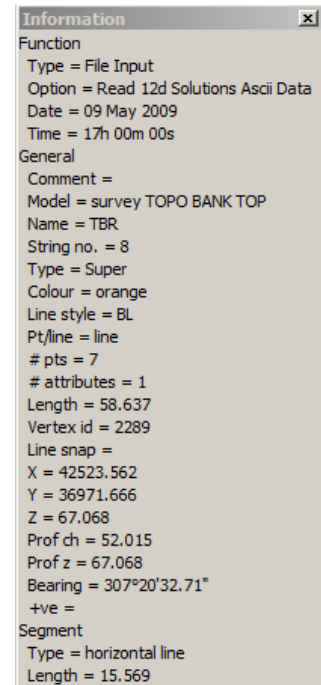
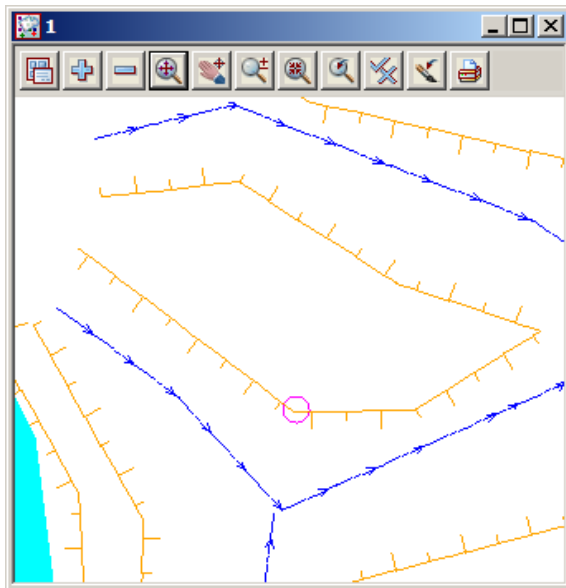

This sequence may seem strange at first. What has happened is that the first pick located a string within snapping distance of the cursor so the string 'highlighted' in yellow and the Information panel for this string popped up. The pick location showed a diamond to indicate that a 'snap to the nearest point' had occurred. 12d is in effect asking you 'Is this the string you want?'. To reject the currently highlighted string, without moving your mouse, simply pick with LB again.

The second pick couldn't find any more strings to snap to (adjacent strings were outside snapping distance) and so no more information panels popped up. Instead, a circle showed at the pick location to indicate that a 'snap to the cursor' location had occurred i.e. the only thing that 12d could find at the pick location was the cursor.

The above sequence will only happen this way if the snap settings are in their default setting i.e. points, line and cursor ON. See below for more about snap settings.

Now if you try to click LB again on the same string, you will only get the yellow circle indicating a cursor snap. This happens even if you try to pick it multiple times.

The reason for this is that 12d only ever gives you one chance to snap to a string in any one picking sequence. Any strings already rejected during the pick sequence will be ignored. The purpose of this behaviour is so that if there are (say) three lines one on top of the other, it is possible to sequentially snap to each one in turn by looking at the Information panel details as you perform each LB mouse click. The fact that we could only snap to one string confirms that there is only one string present at this location.

A quick method of restarting a pick sequence when a string is highlighted, is to move the mouse (i.e. cursor) a short distance from the last pick point. All strings can then be picked again. The next section shows how the mouse buttons can also be used to restart a pick sequence.

To terminate the String Inquire i.e. this pick sequence, click LB on **Finish** in the String Inquire panel.

7.2 Use of Mouse Buttons and Enter Key when using Tentative Picking

The three mouse buttons and the Enter key all have a function when picking strings. Those functions are

LB - Left Button	Select the nearest string
MB - Middle button	Accept the current 'highlighted' string. This will also terminate the current pick sequence.
RB - Right button	Bring up the Pick Ops menu
Enter key	Accept the current 'highlighted' string. This will also terminate the current pick sequence. This is the same as MB and is very useful if you only have a two-button mouse (not advisable).

7.3 Pick Operations Menu via the Right Mouse Button

We will now focus on the use of the RB. Repeat the above picking sequence but now after getting the yellow square cursor (i.e. picking the string), click the RB and the Pick Ops menu will pop up

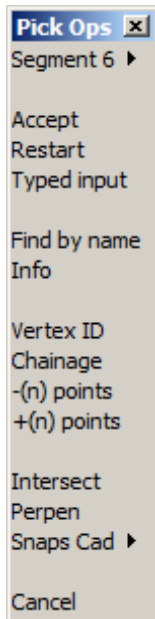

Click with LB on **Restart**. This resets the pick sequence to start over as if the previous pick sequence had never occurred.

If you now try to click on the string with LB, you will notice that the string can now be picked again with the LB. The lesson here is that if you ever get confused during a picking sequence, the safest way to get operational again is to put up the Pick Ops menu, select **Restart** and start over from the beginning.

The **Accept** menu item needs special mention. During a picking sequence, once you have located the string you are after, you normally terminate the sequence by clicking the MB. This accepts the current string and terminates the pick sequence.

The **Accept** menu item has the same function as clicking the MB during the pick sequence i.e. it is used to indicate to 12d that the string found is the one that you wanted. If you are using a 2-button mouse, this is another way around the lack of the middle button (using the Enter key for accepting was described in the previous section). You can accept a string by using the RB to put up the Pick Ops menu and click LB on **Accept**. If you have a 3-button mouse, it is easier to use the MB to accept the string directly.

The **Info** menu item also has a special function. The Information panel that pops up when a string highlights is displayed temporarily. If you move the mouse cursor out of the panel, the information panel will disappear. This occurs even if you don't click any mouse buttons. The **Info** menu item is used to pop up the Information panel (again) of the currently highlighted string.

The **Cancel** menu item is used to terminate many of the operations that are recursive. For instance when creating a string, 12d assumes that it will involve multiple line segments so it stays in create mode after each segment is placed. After the last point on the string is placed, use the RB to pop up the Pick Ops menu and click LB on **Cancel** to terminate the creation.

7.4 Snap Settings

In the context of String Inquire, the snap settings are used to selectively choose from 12d data sets when inquiring on existing items. The snap settings can be toggled on and off from the snaps toolbar.

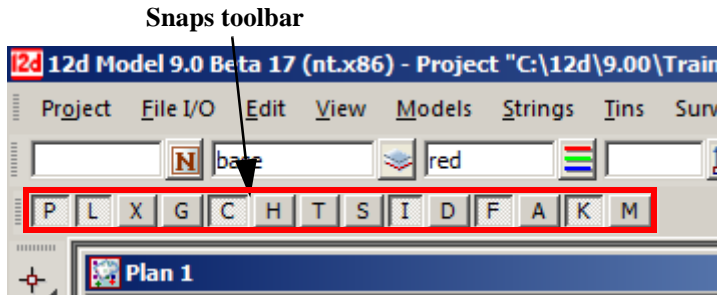

The snap settings can also be set from the Snaps menu under **Utilities** on the Main menu. Click with LB on [Snaps Ops] to pin up the Snaps Ops menu

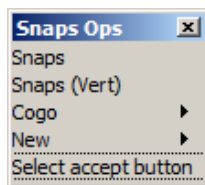

You can select either *Snaps* or *Snaps (Vert)*.

As you use 12d you need to access the snap settings frequently, so it is convenient to leave the snaps menu on display at all times. To minimise menu clutter, the Snaps toolbar and Snaps (Vertical) are merely abbreviated forms of the full Snaps menu. They take up less room on your screen and hence are useful to the experienced user.

Snaps toolbar

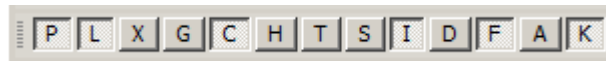

	V x
Point	P
Line	L
Text	X
Grid	G
Cursor	C
Height	H
Vertical snaps toolbar	T
Tin	S
Segment	I
Info	D
Data tip	F
Fast pick	A
Fast accept	K
Fast snaps cad accept	M
Lists all strings within snap tolerance	

At any one time each snap setting is toggled either ON or OFF. For the Snaps toolbar and the Vertical snaps menu, the snap setting is ON when the button is depressed or appears clear and OFF when the button appears raised or blue. The settings shown are the default settings when starting 12d.

If you are new to 12d, it is easiest to use the full snaps menu until you get use to the abbreviations in the Snaps toolbar.

From the Main menu, click with LB on **Utilities=>Snaps=>Snaps**. Move the Snaps menu to the bottom left corner of your screen to get it out of the way.

On the Snaps menu, at any one time each snap setting is toggled either ON or OFF. If a tick appears, the snap setting is toggled ON. The settings shown are the default settings when starting 12d.

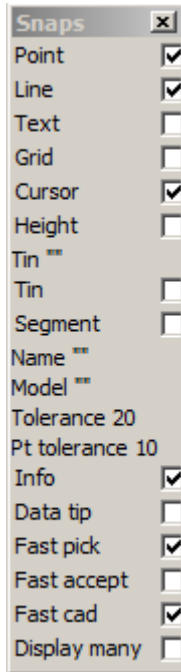

At this stage we will focus on 4 of the first 5 boxes: Point, Line, Grid and Cursor. Upon a successful snap, each snap type returns a unique appearance.

Point Snap - diamond

Snaps to the nearest point or end of line

Line Snap - square

Snaps to the nearest line

Grid Snap - circle

Snaps to the nearest grid intersection point

Cursor Snap – circle

Snaps to the mouse cursor (x,y) position. This is used when drawing freehand.

To change a snap setting, click LB in the snap setting box or on the text describing the snap (e.g. P). The setting will toggle ON or OFF.

As shown above, it is possible to have multiple snap settings on simultaneously. For instance, if you want to be able to select a line on either ‘the line’ or it’s ‘end points’, you need both Point and Line snap ON.

You can generally leave Cursor snap ON. Most times, if all other snaps fail or are not set, you want the mouse cursor position returned. This is useful when freehanding into 12d strings that are not connected to existing features e.g. the centreline of a new road. If you don’t have Cursor Snap ON, you will get a ‘Failed Snap’ error message whenever all other snap settings fail.

Near the bottom of the Snaps menu is an ‘Information’ tickbox labelled **Info**. If this box is NOT ticked, the Information panel will NOT pop up as each string is selected.

Above the ‘Information’ tickbox is the menu item **Pt tolerance 10**. This figure indicates the current point snap tolerance setting is 10. To change the snap setting, click on **Pt tolerance 10** with LB and the following panel pops up

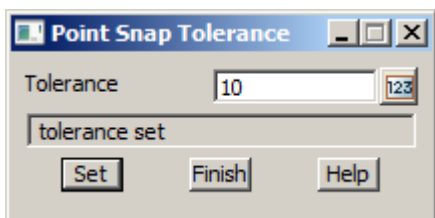

The point snap tolerance is measured in screen pixels. In 1024 resolution, a point snap tolerance of 10 represents about one hundredth of your screen width. If point snap is set, then the closest vertex within this distance of the cursor will be selected.

To change the tolerance, lock the cursor in the *Tolerance* field by highlighting (double clicking on) the existing text, press the Delete key and type a new Tolerance value. Click LB on **Set** to activate the new setting. Click on **Finish** to terminate the panel.

Similarly for the **Tolerance** menu item - click on **Tolerance** and the *Snap Tolerance* panel pops up

NOTE - When *Point* snap is set on, any vertex of a string within the point snap tolerance box around the cursor when LB is clicked, is considered for selection **before any other type of snap is considered**. Centres of circles, centres of arcs and arc end points are considered to be vertices.

When *Line* snap is set on, the cursor only needs to be within the snap tolerance distance of any visible segment of a string when LB is clicked, and that string is considered for selection. Also arcs and circles are considered for selection.

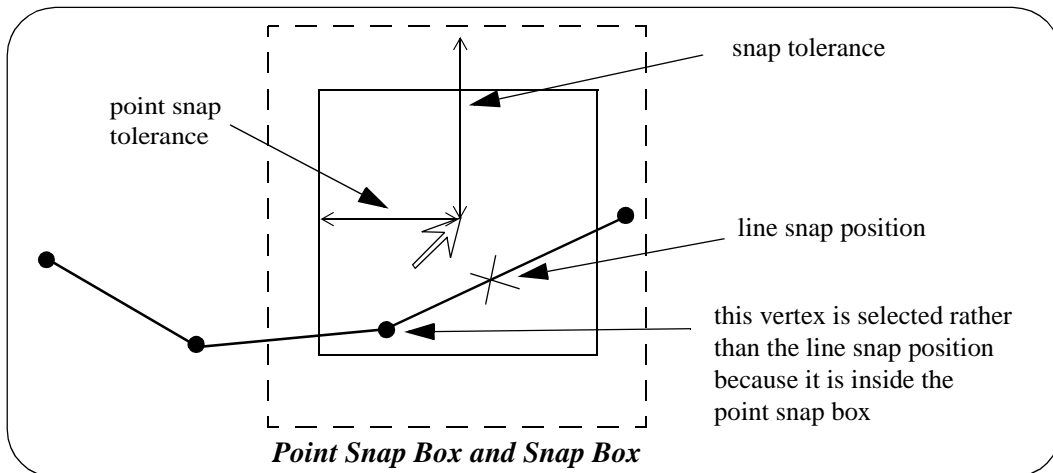

In the area between the point snap box and the snap box, vertices and line snap positions are treated equally and the closest one to the cursor is selected.

To practice this further, do a **Fit** on your current View. Pick a feature in the view where lots of lines meet and without moving the mouse, do a series of 'String Inquires' by repeated use of the LB and observe how 12d will snap to adjacent items near to the mouse cursor. Note the cursor shapes returned that indicate that sometimes you are getting a 'Point snap' and sometimes a 'Line snap'.

Remember points are just a special type of string..

7.5 Models and Snap Settings

Whilst it may appear obvious, it is important to remember that you can only snap to data that is currently on display. Models that are currently turned off will not participate in the selection process during snapping. If you find that you are snapping to unwanted items, consider turning off models that are irrelevant to your current operations

7.6 Fast Picking

To **Fast pick** a string, simply move the cursor near the string and **click MB** or type <enter>. The nearest string to the cursor satisfying the snap conditions is selected.

Hence using **MB** alone replaces a LB followed by an MB.

7.7 Modifying the String Highlighting Colour

12d has various default parameters for the display of data including the string highlighting colour. This is the colour a string is changed to whilst it is selected.

The default highlight colour is *white* but this is not be very useful if you want to draw strings in white, or if you use a white background colour. In either case, it is important to change the highlight colour to a colour other than the white.

To check the highlight colour for the project, we select from the main menu **Project => Management => Defaults** and the **Defaults** panel pops up.

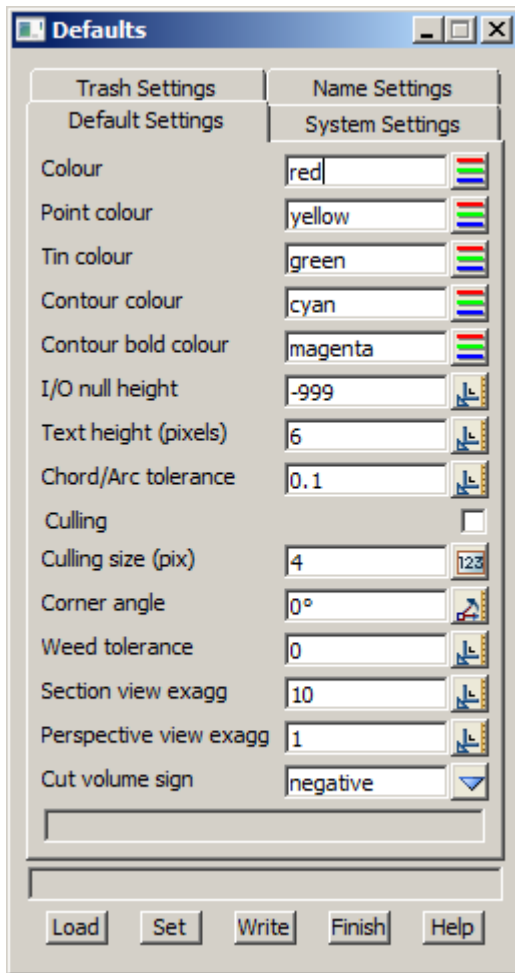

From this panel, the user can change various parameters for this project that 12d uses for calculations, display and data handling.

To change the default highlight colour, select the *Systems Settings* tab by clicking LB on the 'Systems Settings' tab.

The following panel should appear:

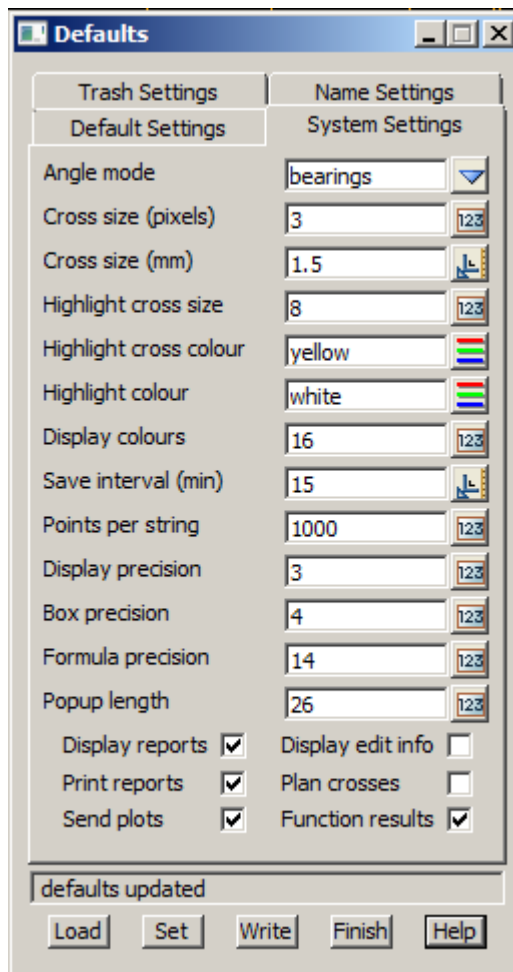

Note that the Highlight colour is set to white.

To change this, LB click on the colour icon adjacent to the Highlight colour input box and select another colour such as cyan from the colour choice box. Then press **Select** on the colour choice box panel. Colours can more quickly be selected from the choice box by double clicking LB on the desired colour - the Select button is not required.

To set the current values for the defaults press the **Set** button.

NOTE: When a new project is created, the values in the **Defaults** panel are loaded from the set-ups file *defaults.4d* which 12d Model looks for on start up in the standard 12d location (for more information on the search order, see Appendix J 'Set Ups' in the on-line Reference manual). For an existing project, all the values in the **Defaults** panel are saved with the project so if any have been changed in the project after the project was first created, then the defaults for the project will differ from those in the *defaults.4d* file.

If you wish to keep the current defaults for a project to use as the initial defaults for future new projects, you can save the file **defaults.4d** to a suitable location by clicking on the **Write** button to bring up the **Write Setup File "defaults.4d"** panel.

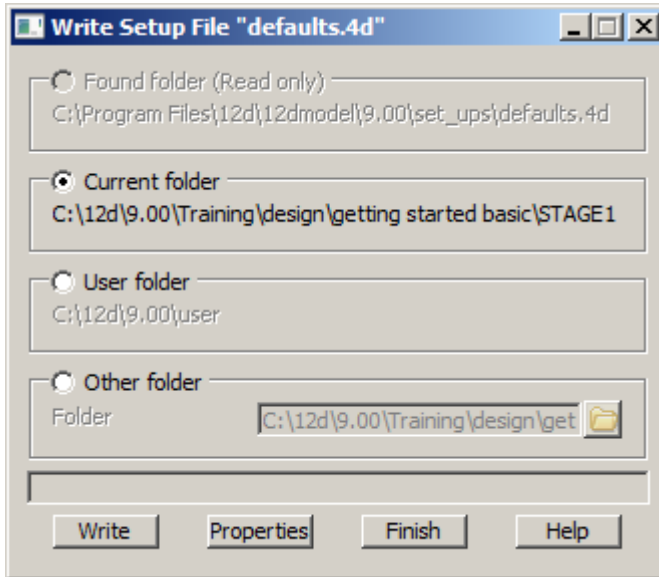

Specify where you wish the *defaults.4d* file to be saved and then click on **Write**.

In this example select the Current folder. If you wanted the changes to apply to any new project you create then you would save the changes to the 'User folder' as shown above

Click on **Finish** to close the **Save Setup File** panel, and then **Finish** on the **Defaults** panel.

8 Creating Strings with CAD

We will now investigate creating strings using the CAD options. We will create points (one point strings), a 2 point line (single segment string) and a line string (multiple segments in the string).

First we will create a new plan view to work in.

From the main menu, click LB on **Views=>New=>Plan**. This will create View 'Plan 3'.

Maximise the view by clicking on the *Maximise* icon on the top right hand corner of the view or by double clicking on the plan view title area.

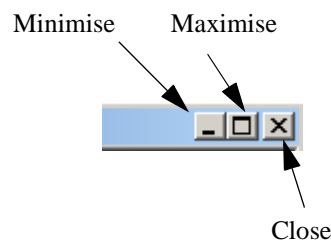

8.1 Creating Points

The CAD options to create points, lines etc. can be done by using the main menu system or by the use of the CAD **toolbar**, which is displayed on the left of the screen at start-up. Regardless of the method used to activate the CAD commands, the CAD **controlbar** as outlined on in Chapter 4.5 will be used to define the characteristics of the created elements. We will change the values in the **controlbar** as follows.

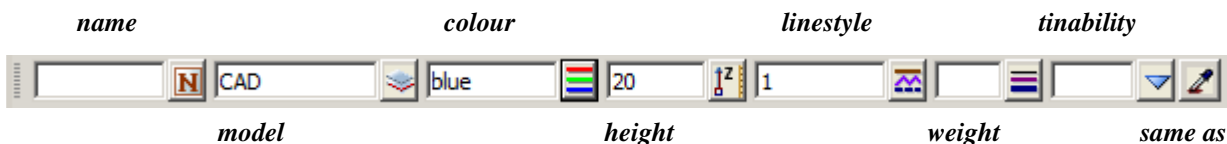

Click LB in the model field and type in 'CAD'. Click LB on the colour icon and choose the colour *blue* from the choice box by double clicking on *blue* in the pop-up list of colours. Enter '20' into the height box and leave the linestyle type as 1.

To create a point string (i.e. one vertex string) we will use the CAD **toolbar** flyout. Pick the points section of the toolbar by clicking LB over the create point symbol and keep LB depressed.

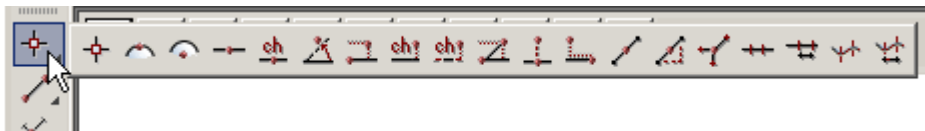

The points **flyout** menu is displayed which has all the options in the points section of the CAD creation tools. This is displayed as a horizontal bar consisting of all the icons that make up all the options in the points section of the CAD tools. Whilst holding down LB move the cursor over each of the icons and the **tooltip** function tells what each of the options does.

To select an option, keep the LB depressed until the cursor is placed over the specific option you want and then release the LB. We will select the 'Create Point' option which is the first icon in the **flyout**.

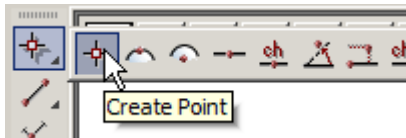

On selecting the **Create Point** option, or any other CAD option, the user is prompted for the relevant data in the screen message box located on the bottom left hand corner of the 12d Model application window

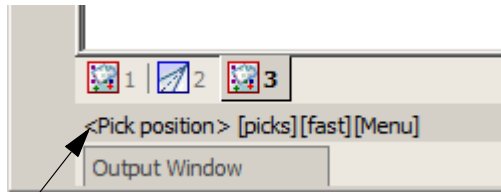

Message area

The user can select a position with the mouse and on accepting that point (Middle mouse button or enter) the point is created at the selected position. The model, colour, height etc. are defined in the **Cad Controlbar**.

The snap mode will influence the mouse selection. For example if cursor snap is on, the user can choose a position not yet defined. If point snap is on and the selection snaps to an existing point, the option will place another point at that location. Ensure that the cursor snap is activated in the snaps **toolbar**. Click LB at a position roughly in the middle of the view.

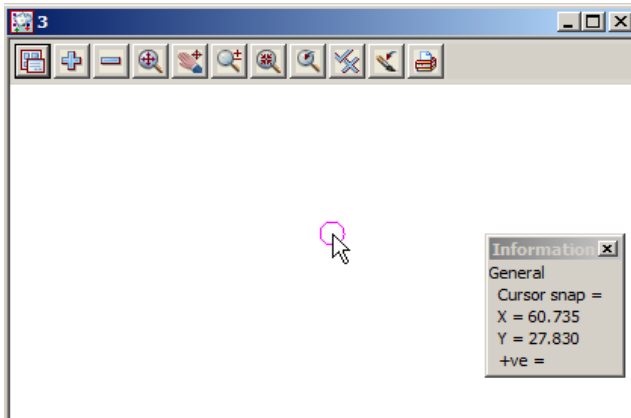

Click MB. The point is then created with the model 'CAD' being added to the view automatically.

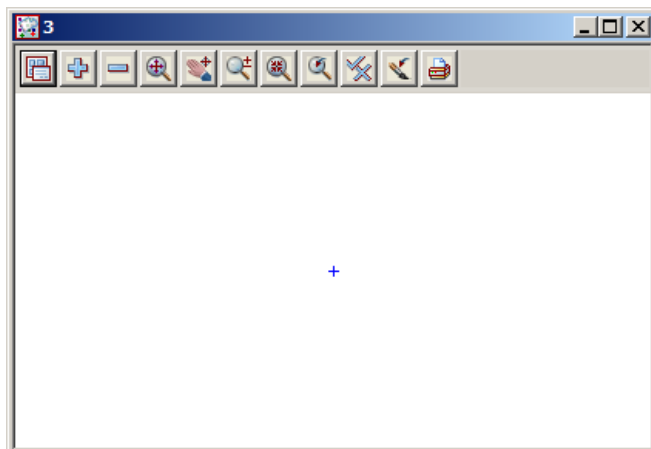

To see the height of the point we must toggle on the Z values. To do this click LB on the toggle button on the view menu to bring up the toggle menu. Then click LB on the 'Z values[n/a]' position. Don't walk right on the arrow near this position. This is to specify individual models to turn the Z values on or off. By clicking LB on the Toggle menu, you turn on (or off) all Z values in that view for all models.

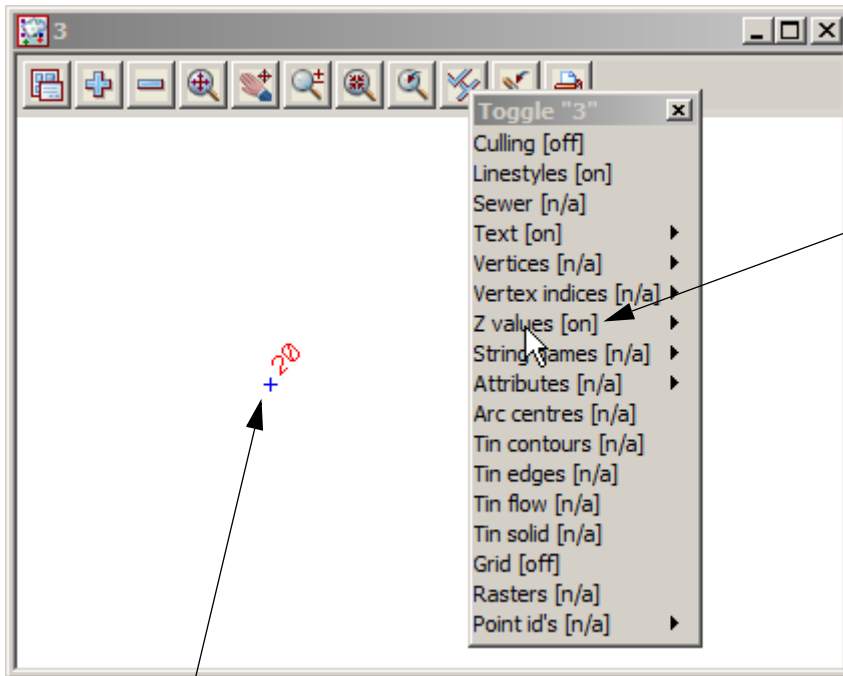

The Z value is then shown near the point that we created.

The default colour for the height text is yellow. To change the colour of the height text so it clearer we can click LB on the menu icon from the view menu to bring up the plan view menu. From that menu we can click LB on **Settings=>Z values=>Single** to bring up the **Z values For Plan View** panel. From this panel, select the colour icon and then select the colour red by double clicking LB on the red colour. It should like as above:

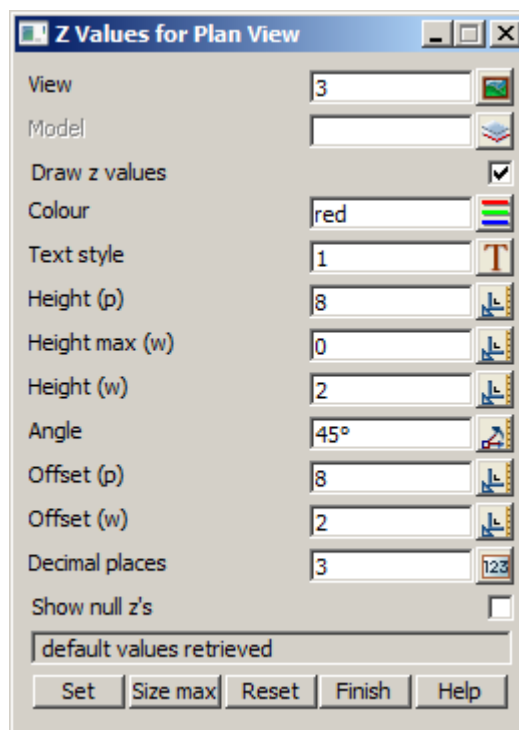

Then press **Set** on the panel to set that colour. Finally press **Finish** to close the panel.

The change is made only for view 3. Any other points added to the view will now have their height text shown in the red colour.

There are various ways of selecting a position when creating a point. Specification of a position can also be done by the direct input of the xyz coordinate of the point by pressing the space bar to bring up the enter XYZ panel or by typing of the value to bring up the XYZ panel. The user then enters the X, Y and Z value into the box separated by a space. e.g. 200 150 40. As we have already set a Z value in the CAD **controlbar**, you only have to specify a X and Y value into the box. **NOTE:** The Z value will default to the value entered into the CAD **controlbar** whether or not it is specified in the XYZ box. If no height value exists in the CAD **controlbar** or the XYZ box, then a value will be interpolated if possible, otherwise a 0 value will be assigned.

We will again create a point by using the CAD **toolbar**.

Firstly, change the Z value in the CAD **controlbar** to '50'. Then repeat the steps outlined above to choose the Create Point option. Instead of selecting a point with the mouse we will type in the coordinate values. To pop up the XYZ box, press the spacebar. Then type into the box, 200 100 and then press the enter key. We did not have to specify a Z value in XYZ box as it was already defined in the CAD **controlbar**. **NOTE:** A space must be placed between the X and Y values.

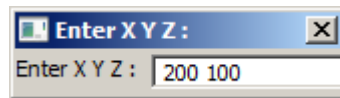

A new point is created. Click LB on the Fit icon on the view menu  to fit the data in the view.

It should now look like as shown below:

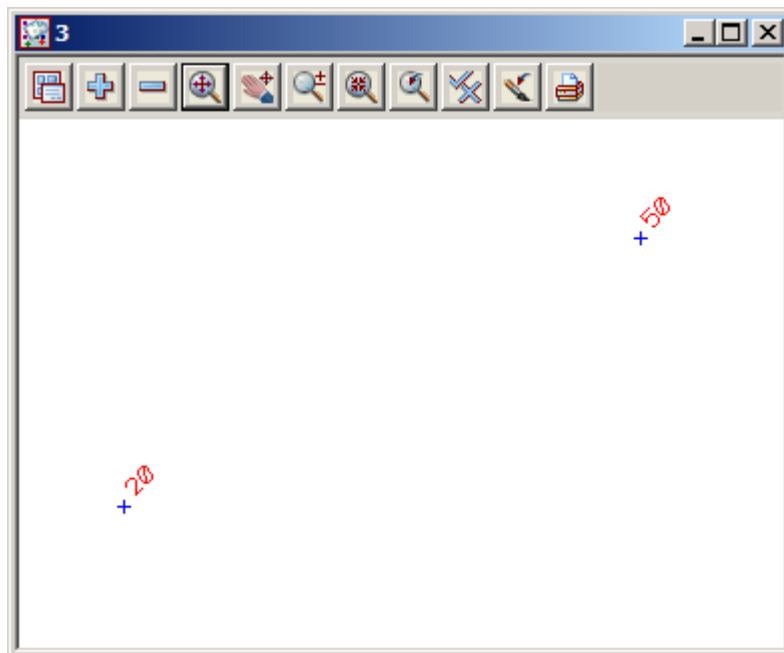

8.2 Creating Two Point Lines

We will now create a simple one segment line. To do this we will use the CAD **toolbar** flyout. Pick the lines section of the toolbar by clicking LB over the create line symbol and keep LB depressed.

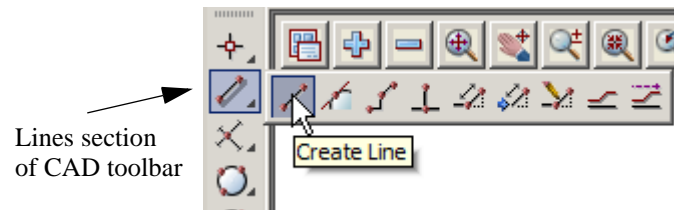

The lines **flyout** menu is displayed which has all the options in the lines section of the CAD creation tool. Select the 'Create Line' option which is the first icon in the **flyout**.

On selecting the **Create Line** option, the user is prompted for the relevant data in the screen message box located on the bottom left hand corner of the 12d Model application window

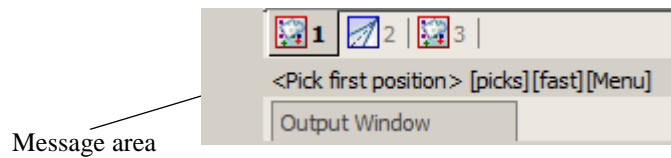

We will pick a position with the mouse to define the start of the line. Pick a position with LB about halfway between the two existing points and then MB to accept. After accepting the start point, the user is told in the message area to pick the end of the line. You will also notice when you move the mouse around that a line is drawn 'rubber banding' to the cursor position. We now select a point going south east to define the end of the string with LB and MB to accept. The created string will be shown given the parameters given in the CAD **controlbar** at the time of construction.

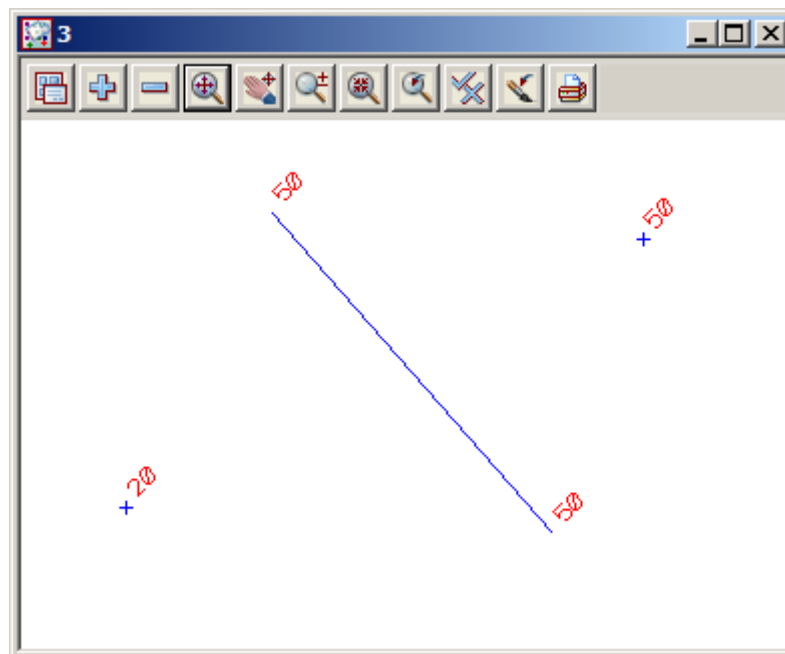

8.3 Creating Line Strings

We will now create a multi-segment string. To do this, we will use the CAD menu from the main menu system rather than from the CAD toolbar

From the main menu, click LB on **Strings=>CAD=>Lines=>Line string**. The **Create Line String** option will now be running. **NOTE:** These options have no panel assigned to them.

The same option can be started from the CAD toolbar as we did for the **Create Line** option except we choose the **Create Line String** icon from the flyout.

On selecting the **Create Line String** the user is prompted for the relevant data in the screen message box located on the bottom left hand corner of the 12d Model application window

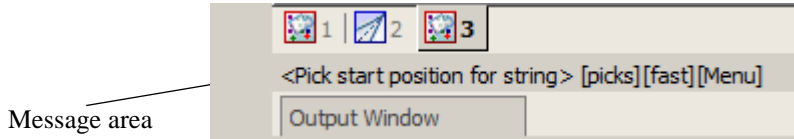

We will pick a position with the mouse to define the start of the line. Pick a position with LB any where on the view and accept with MB. Then move the cursor to a new position and pick and accept a second point. Pick and accept a third point and so on. To finish the string simply press the Esc Key on the keyboard or alternatively RB and then select cancel from the **Pick Ops** menu. The string will be created using the parameters given in the CAD **controlbar** at the time of construction.

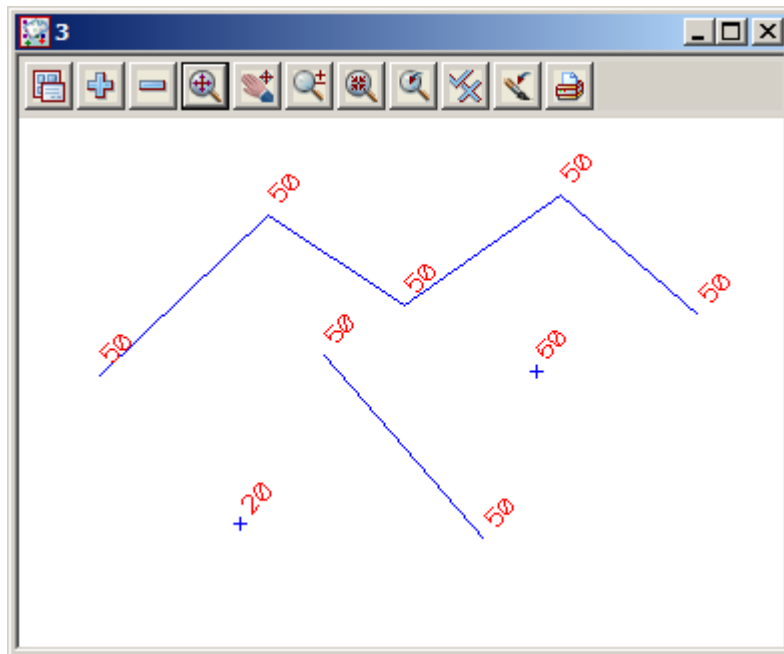

This has given a small introduction to the use of the CAD options. For a more detailed explanation of these tools see Chapter 14 'Strings' in the on-line reference manual and follow the links to the CAD options.

We will now finish this section by deleting the current view. As the view is maximised, select **View => Delete** and select view '3'. Alternatively, we could have restored the view and click LB on the 'X' icon at the top right of the view. This should then leave two views, Plan 1 and Perspective 2. If either Plan 1 or Perspective 2 are left maximised, select the restore button on the top right hand side of that view to leave two views as at the start of this chapter.

Clear the value for the default height in the Cad Controlbar. Leaving the height there may create problems when creating strings at a later stage. Also change the default model to one of the existing survey models

as deleting the current model is not recommended.

Finally, we will delete the 'cad' model. To do this we click LB on the *delete model* option from the main menu **Models=>Delete=>Delete a Model**. This brings up the **Delete Model** panel

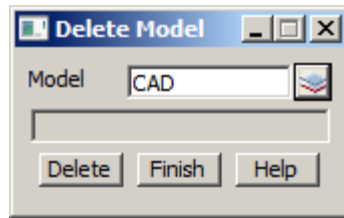

Select the model icon with LB and then double click LB on 'CAD'. Then click on the **Delete** button, and answer yes to any warnings (after reading them). This then deletes the model from the project.



9 Survey Data Reduction

9.1 Coding

9.1.1 Feature Codes

Feature codes are used to define surveyed points in the field. The code will be used to assign properties such as model name, colour, symbol and linestyle via a mapping file.

```
.0200      270.0211      TR0000 FRUIT
.2054      244.7961      TR0806 FRUIT
.9951      240.6725      TR0806 FRUIT
.1618      197.2388      TR0406 WILLOW
.6466      200.8138      TR0406 WILLOW
.9474      196.3686      TR0406 WILLOW
1.6766     116.0166      TR0406 WILLOW
3.6258     117.3819      TR0406 WILLOW
.8728      117.5113      TR0406 WILLOW
```

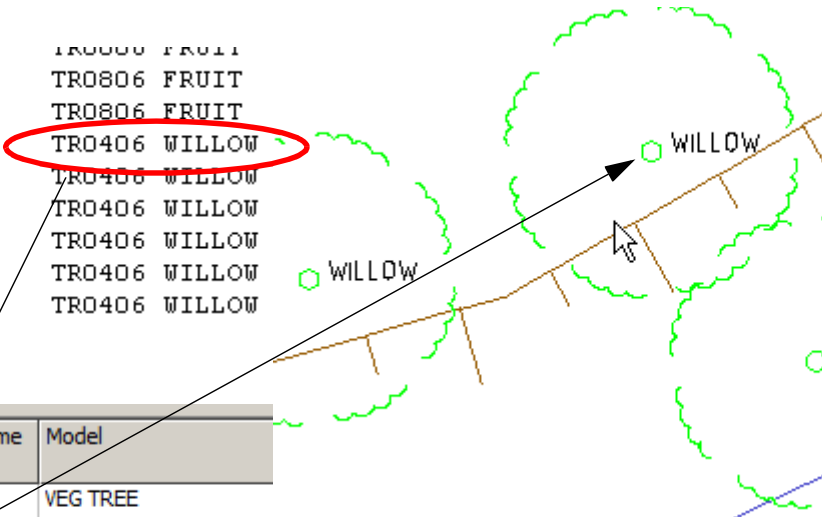

	Key	Att Key	Name	Model			
327	TR0404			VEG TREE			
328	TR0405			VEG TREE	GREEN		POINT 0
329	TR0406			VEG TREE	GREEN		POINT 0
330	TR0407			VEG TREE	GREEN		POINT 0
331	TR0408			VEG TREE	GREEN		POINT 0
332	TR0409			VEG TREE	GREEN		POINT 0

9.1.2 Field Codes

Field codes are used to enhance the effect of feature codes.

Field codes are defined for each data collector and are set up in the **Survey.4d Create/Edit** panel.

We will look at how to bring up this panel later (see **“Creating/Checking/Modifying a 12d Data Collector Definition”** later in this chapter)

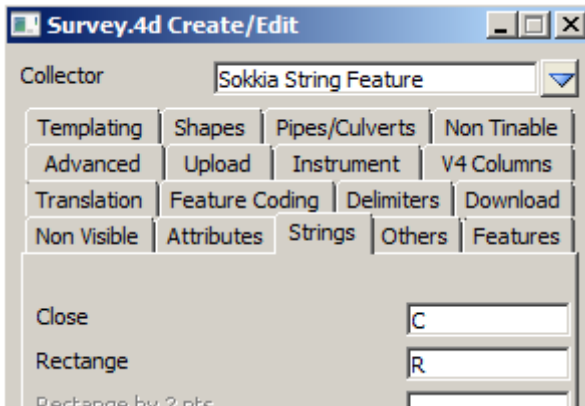

In the *Survey.4d Create/Edit* panel, Field Coding is set up under the panel tabs: **Templating, Shapes, Pipes/Culverts, Non Tinable, Feature Coding, Non Visible, Strings, Others and Features**

The Field codes are user definable and can be any letters. It is advisable to ensure that the codes used are not the same as feature codes.

A list of Field codes can be found in the Reference manual.

9.1.3 String numbers

Numbers can be used to differentiate separate strings using the same code.

11111	354.88750000	21DW
72222	6.0394444400	21DW
38889	323.98361111	21DW
27778	316.98361111	21DW
00000	241.93972222	22DW
72222	211.22555556	22DW
50000	205.80055556	22DW
38889	203.95638889	22DW
38889	193.41583333	22DW
500000	184.32972222	22DW
555500	169.89805500	CHK901

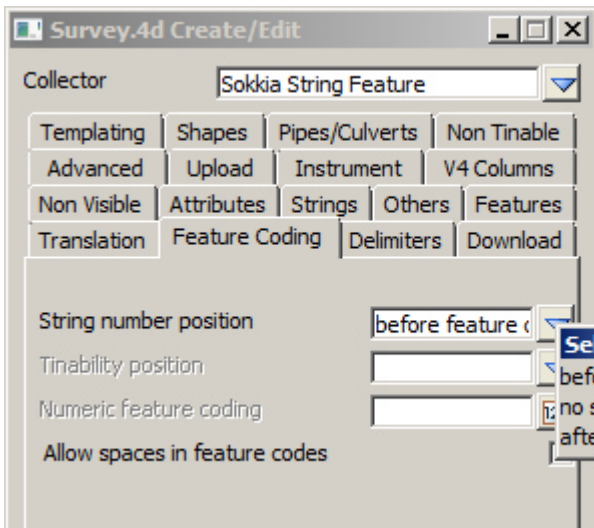
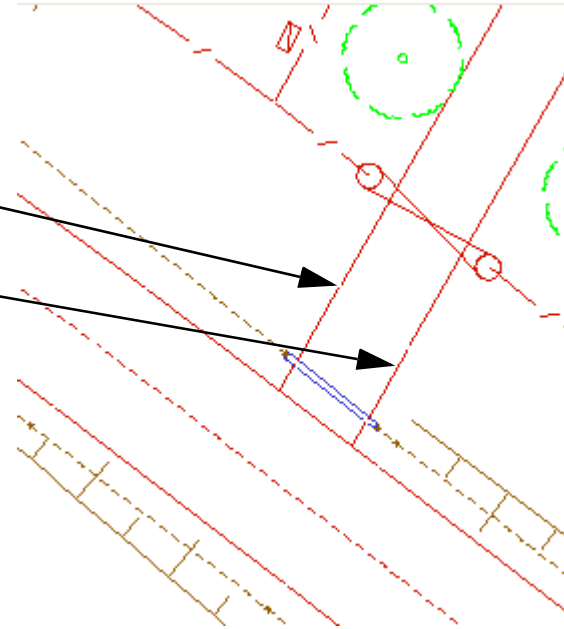

The string number position is specified under the **Survey Data Setup** menu under the **Feature Coding** tab

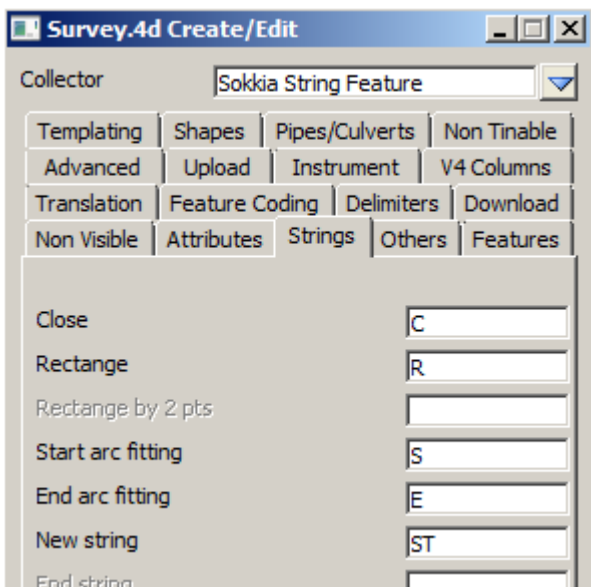

String numbers may be omitted and a **New String** command can be included after the code. This is set up under the **Strings** tab

63083333	12DW
99833333	12DW
79444444	12DW
35750000	13PL*ST
33083333	13PL
.8083333	13PL

9.1.4 Delimiters

There are a number of delimiters used in 12d. Two commonly used ones are the code delimiter and the comment delimiter.

27770	108.94333300	TRO309 WATTLE
13888	81.141111100	TRO306 GUM
02777	292.79027700	TRO608 GUM
11111	350.24777700	25FE
55555	5.8144444000	25FE*XN
00000	60.870277800	25FE
13888	74.994166700	25FE*27BU
88888	78.408333300	25FE
47222	80.721111100	25FE

A Comment delimiter (space) is used to separate a feature code from a text description

A code delimiter (*) is used to separate multiple feature codes and/or feature codes and field codes

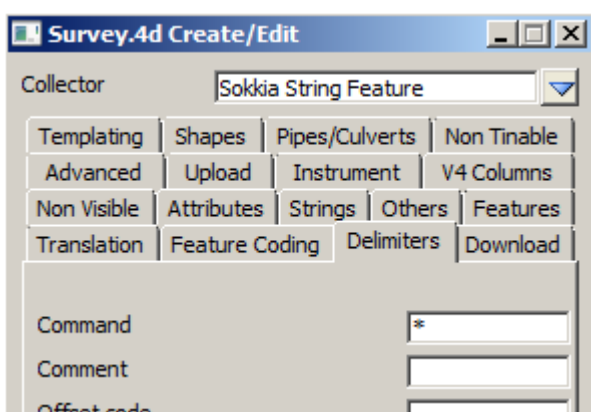

The Delimiters can be defined under the **delimiters** tab of the **Survey Data Setup** menu

9.2 Setting up a New Project

Before we can reduce the survey data, we first we need to create a project to read the survey data into. We will create a new project called 'DETAIL SURVEY' in the Survey Getting Started training area.

First, double click on the *12d Model 9* icon to bring up the **Project Selection** panel.

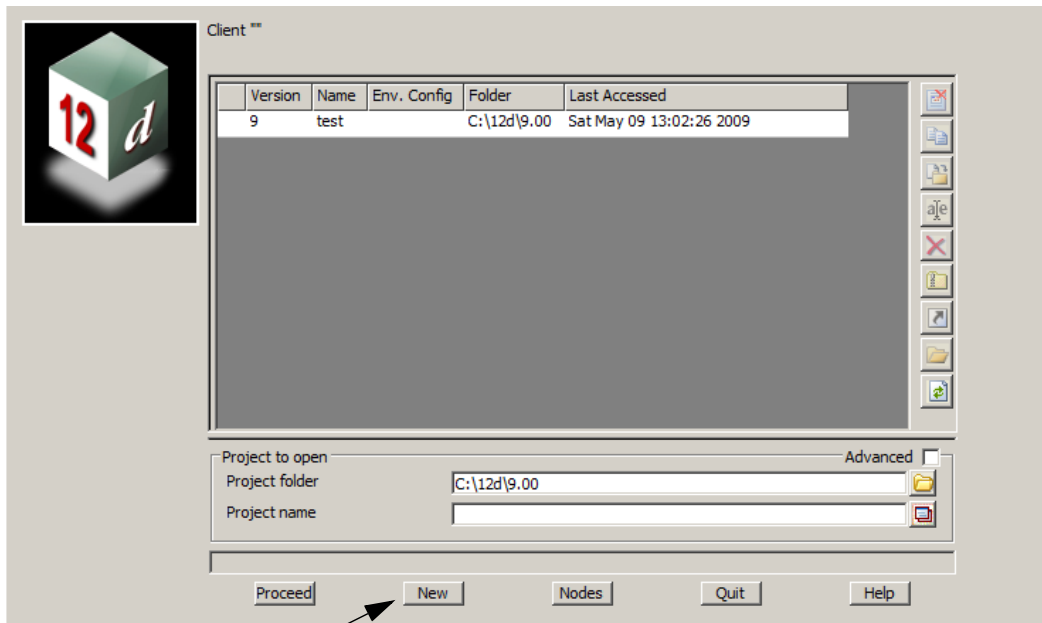
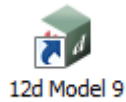

Select **New** button to bring up the **New project** panel.

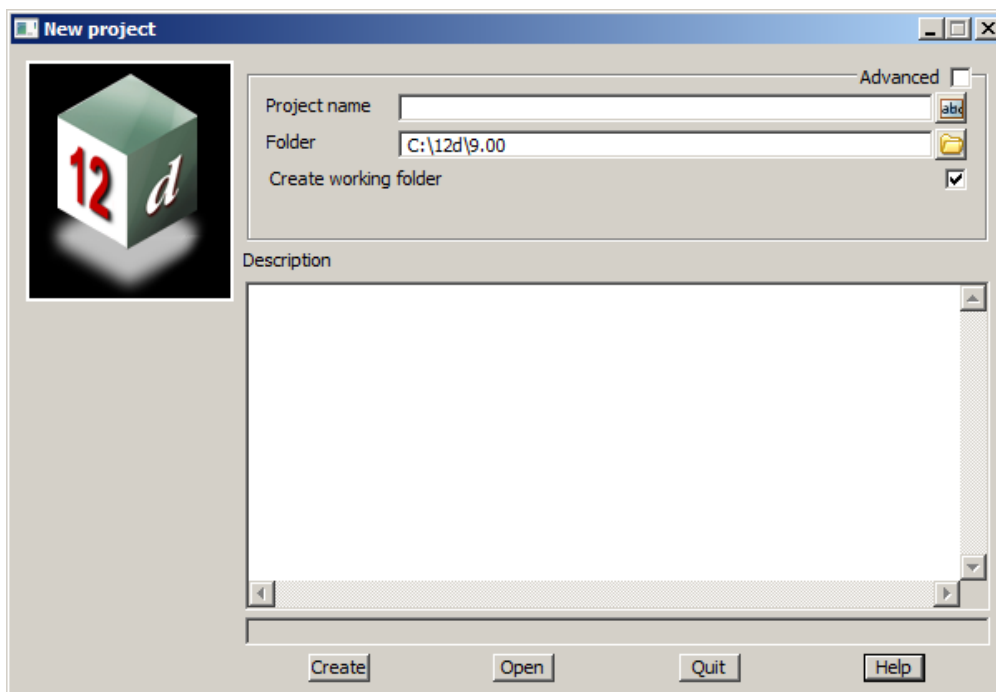

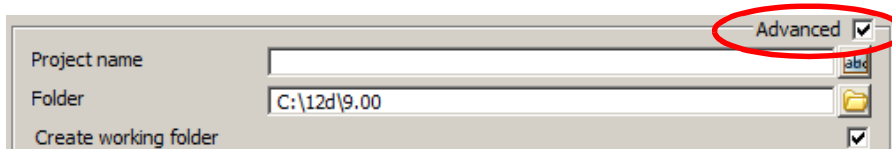

Click on the Advanced tick box

This will allow us to edit the registry file.

Inside the registry file we can then create a link to the environment file that nominates the setup files for this project
 Once this is done the setup files remained linked to the project

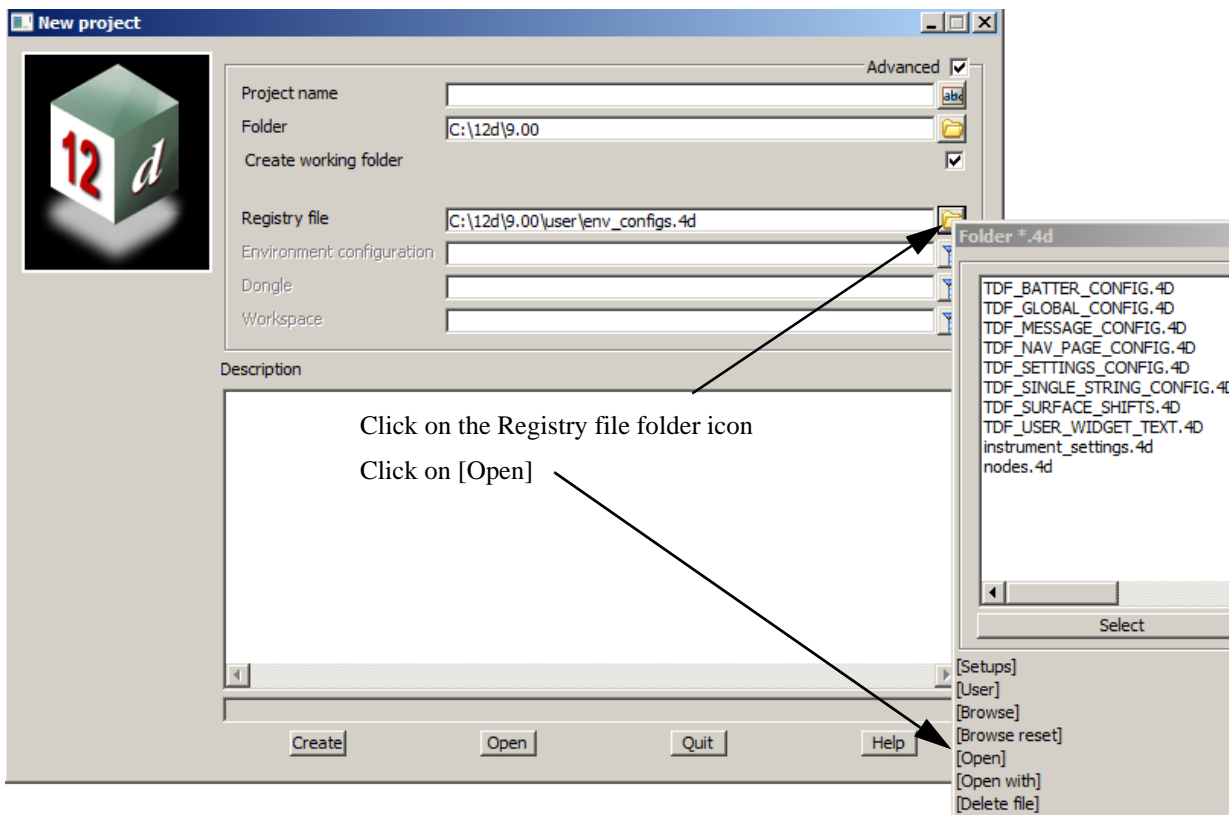

Click on the Registry file folder icon
 Click on [Open]

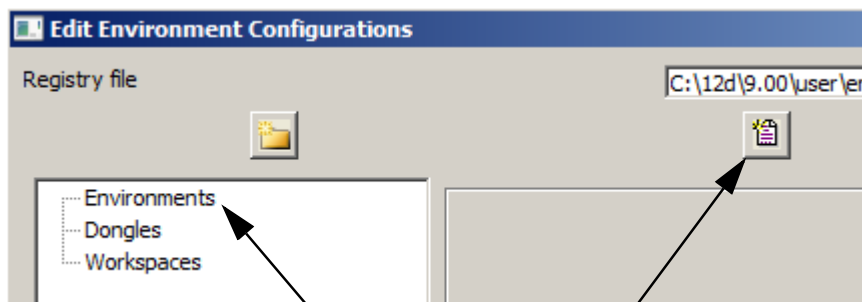

Click on *Environments* then click on *Insert* icon to add a new config name

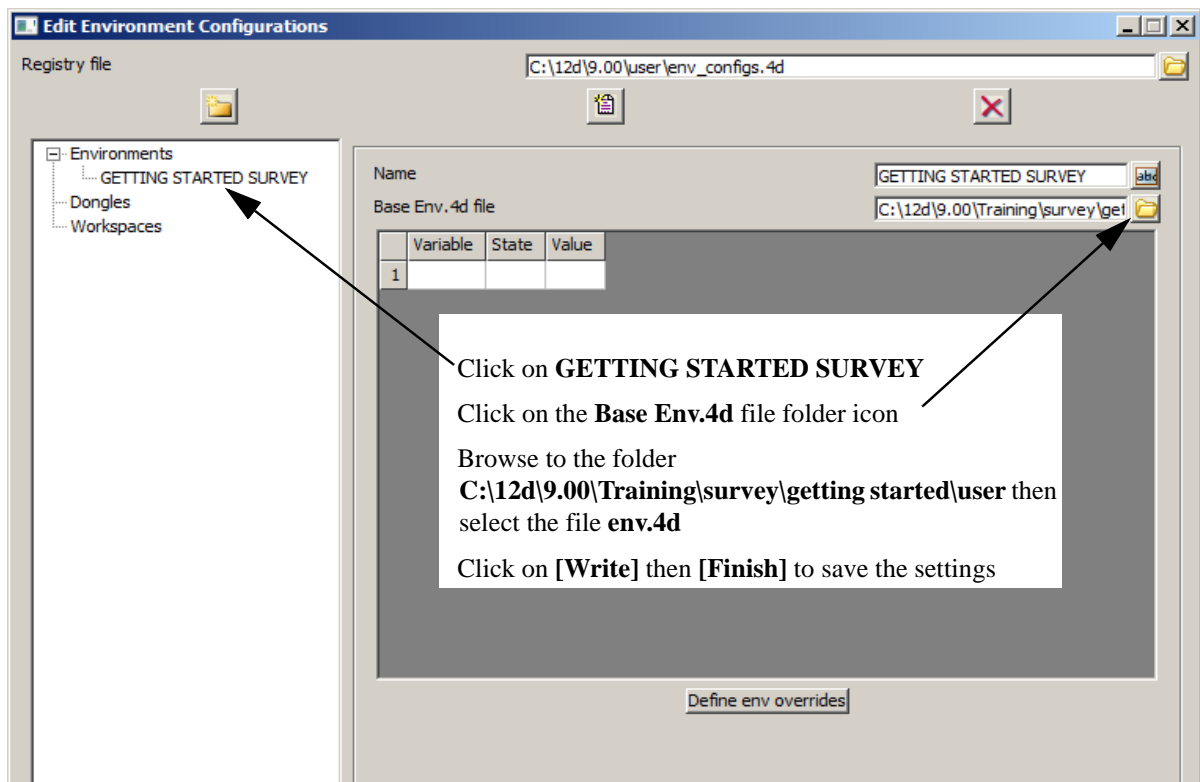
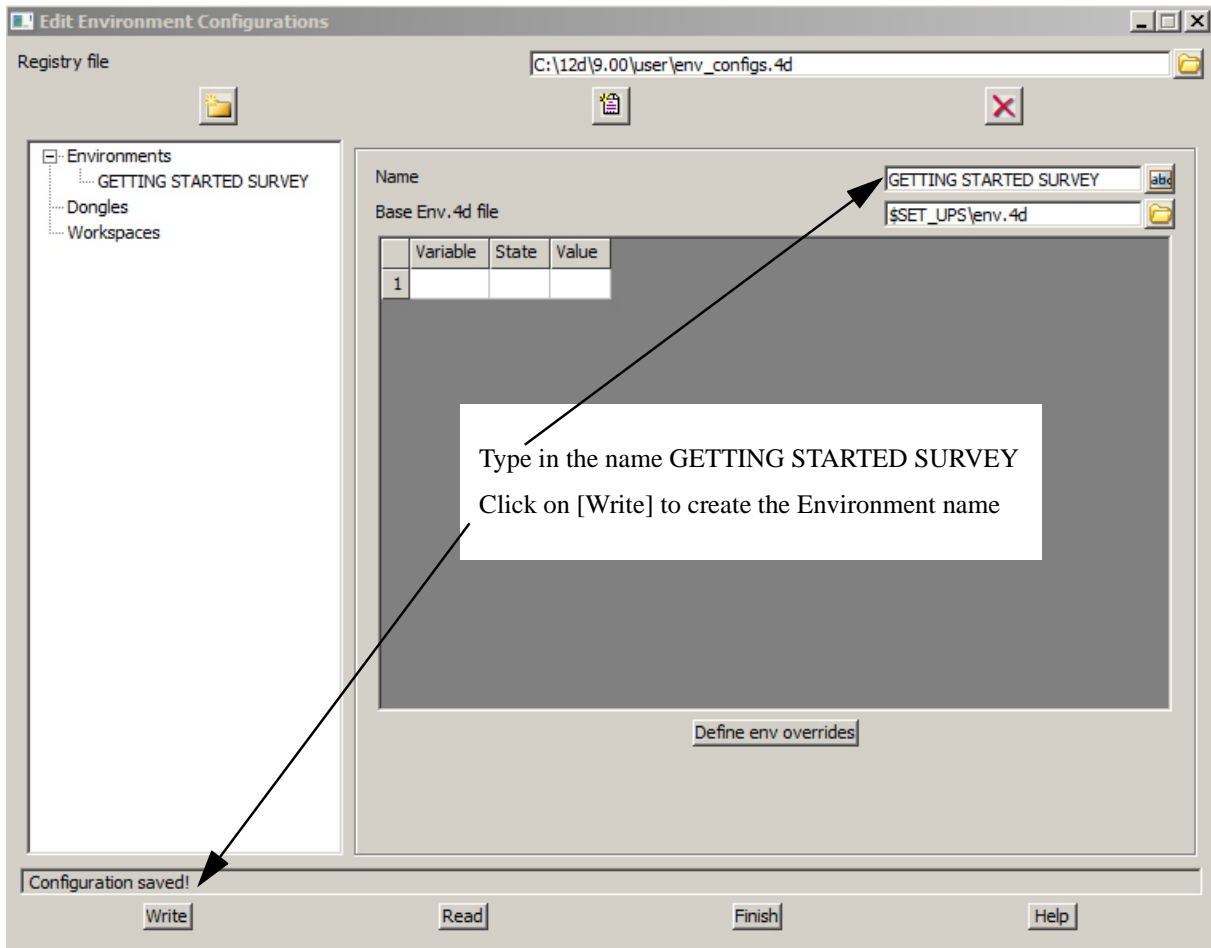



To now use the Config file name just set up we click on the Environment configuration choice icon
 Expand the Configurations by clicking on the [+] icon then double click on **GETTING STARTED SURVEY**

Once the Configuration name has been created any new project can be started by firstly selecting this name in the above manner

For the project name type in **DETAIL SURVEY**

Select the Folder icon then browse to folder
C:\12d\9.00\Training\survey\getting started

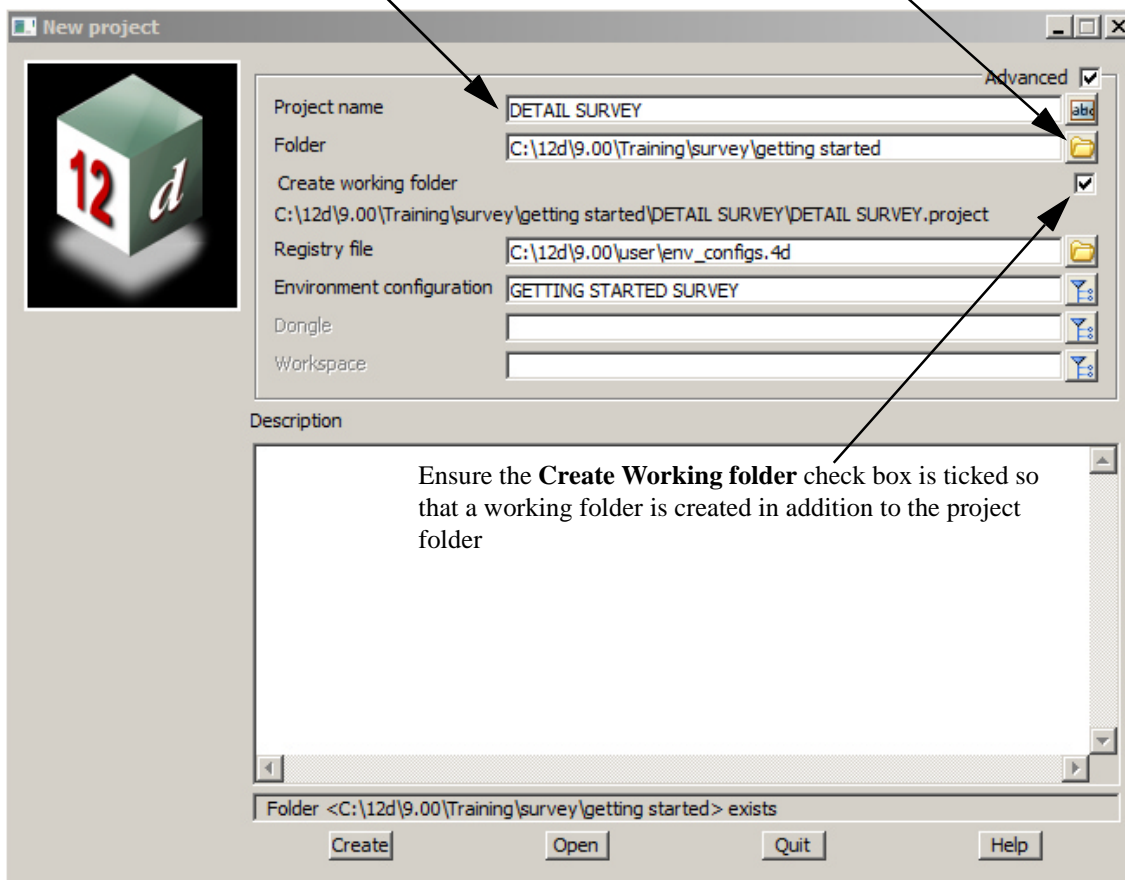

Click on **[Create]** to open the new project

9.2.1 Screen Setup

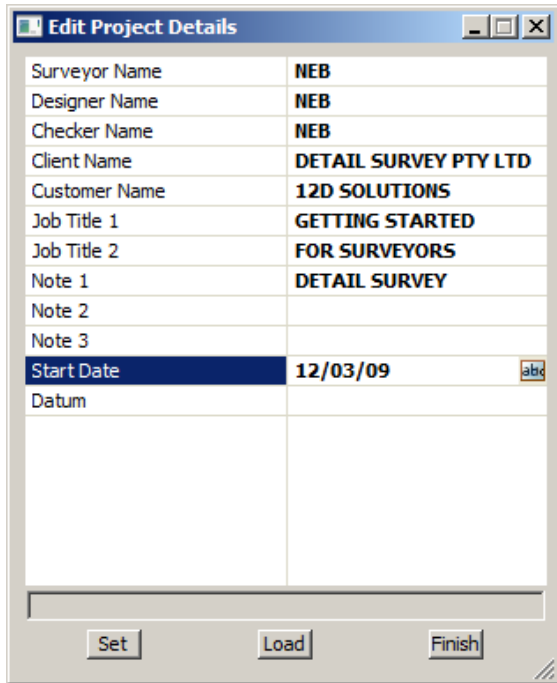

When the project starts up for the first time the **Project Details** panel appears

The information typed in here can be used when plotting from this project

Fill in the various prompts if necessary

Select **Set** then **Finish** to save the settings and continue

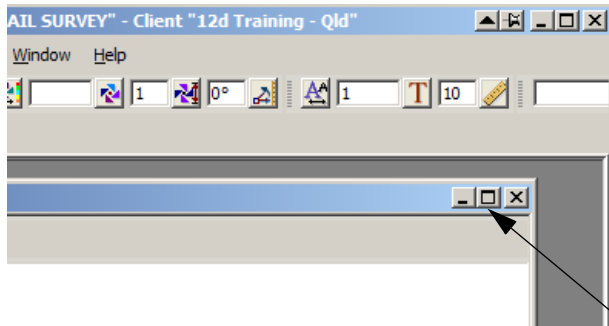

Maximise the plan view

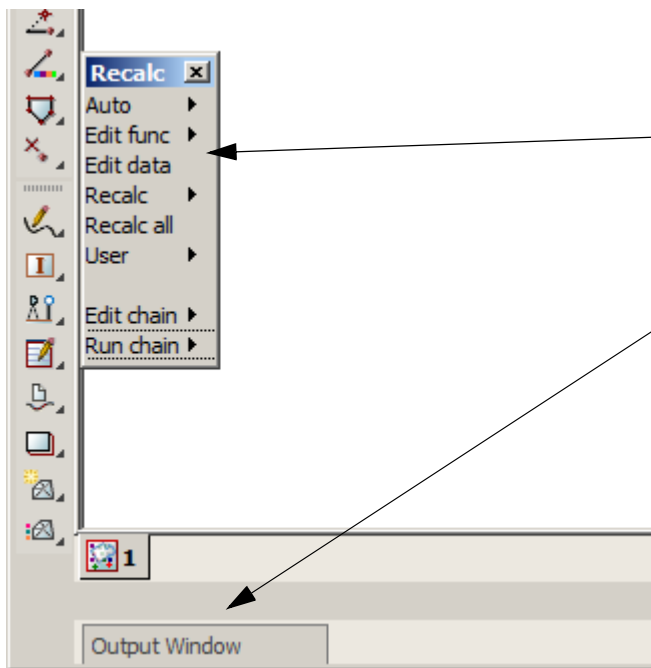

Move the **Recalc** panel to the bottom left

If the **Output window** tab is highlighted blue you can move the cursor over the tab to display the error message if any. Normally when creating a new project there are optional file that are not found.

9.2.2 Project description

It is useful to keep a record of operations performed in the project.

Select option

Project=>Details=>Description

Type in the details

Select **Set** then **Finish**

Alternatively after selecting **Set**
the panel can be minimised for

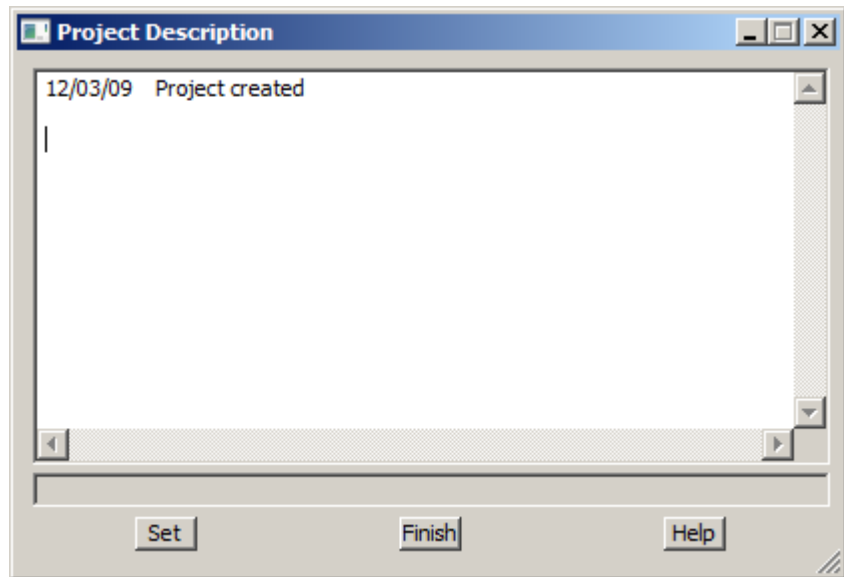

9.3 Survey Station Coordinate entry

Co-ordinates for the survey stations can be stored in the data collector file or created in the project by a number of methods. For this example we will read in an ascii file with the station co-ordinates.

Select the option **File I/O=>Data Input=>12da / 4da data**

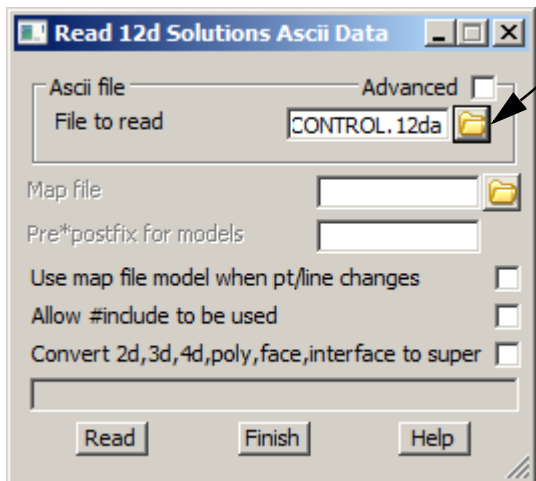

Select the **File to read** folder icon
Browse up one level to the folder
C:\12d\9.00\Training\survey\getting started
Select the file **CONTROL.12da**

Click [**Read**] and the station points will appear on the screen

Note that a new option in 12d allows the data to be displayed on the screen as it is read in.

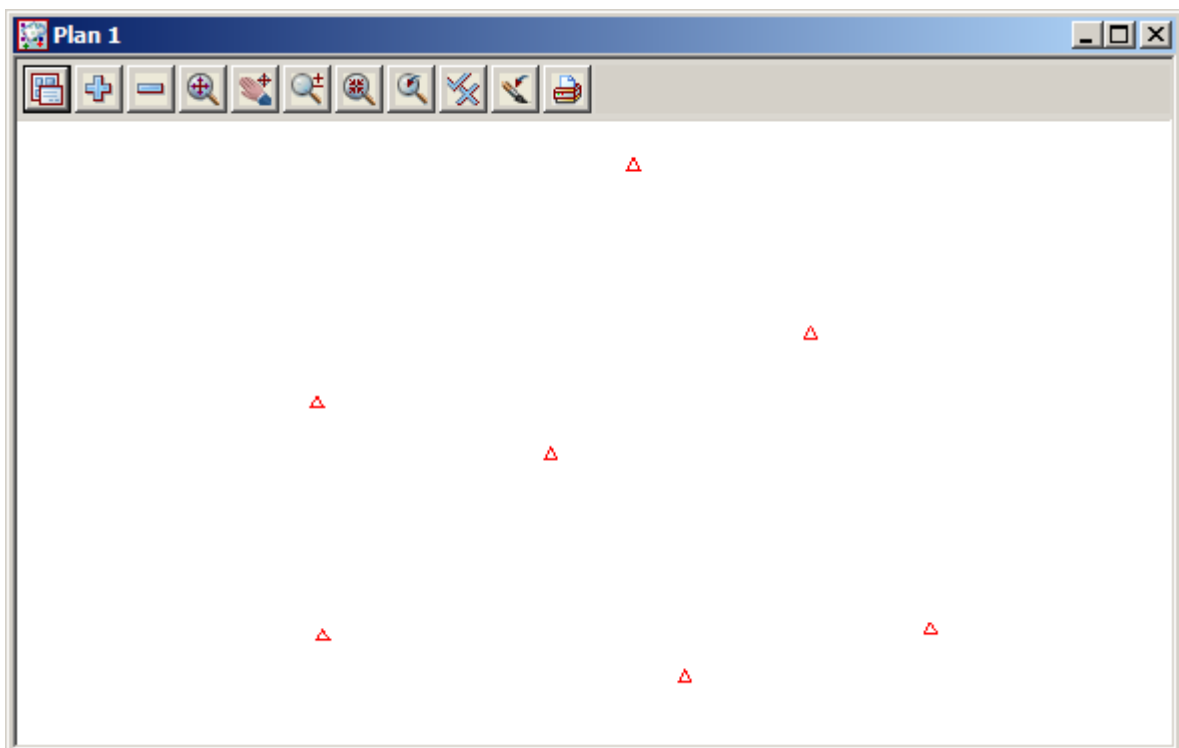

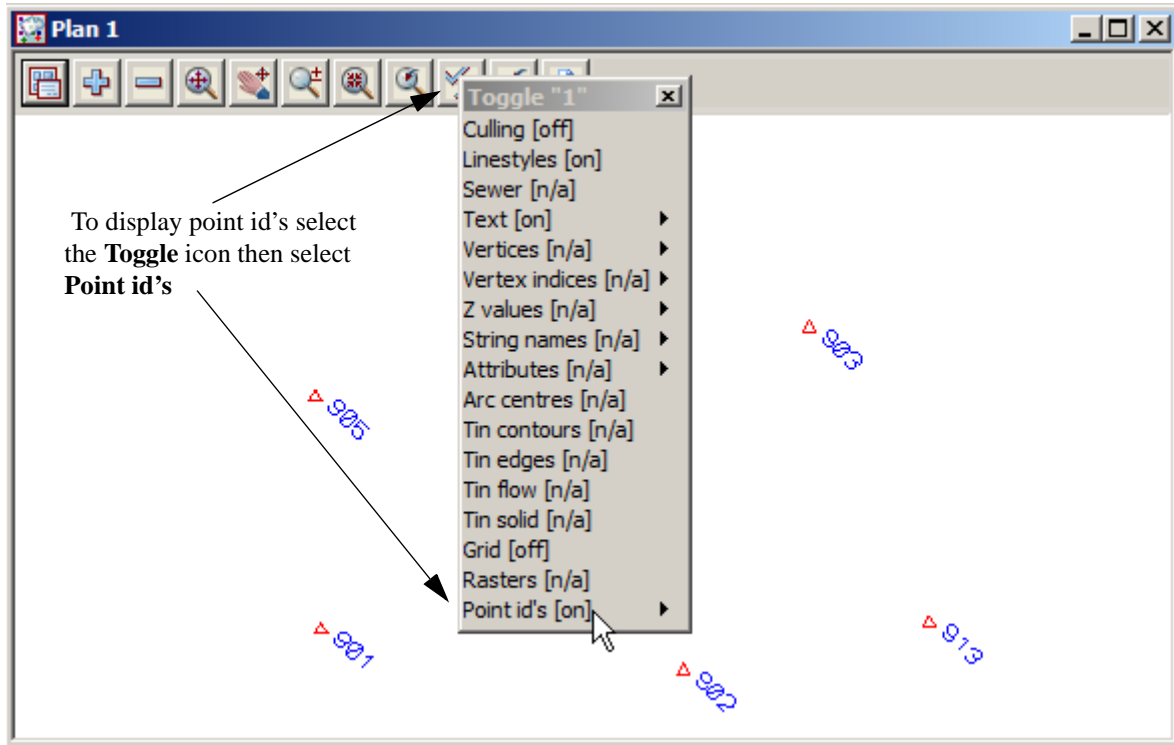

9.4 Data collection reduction

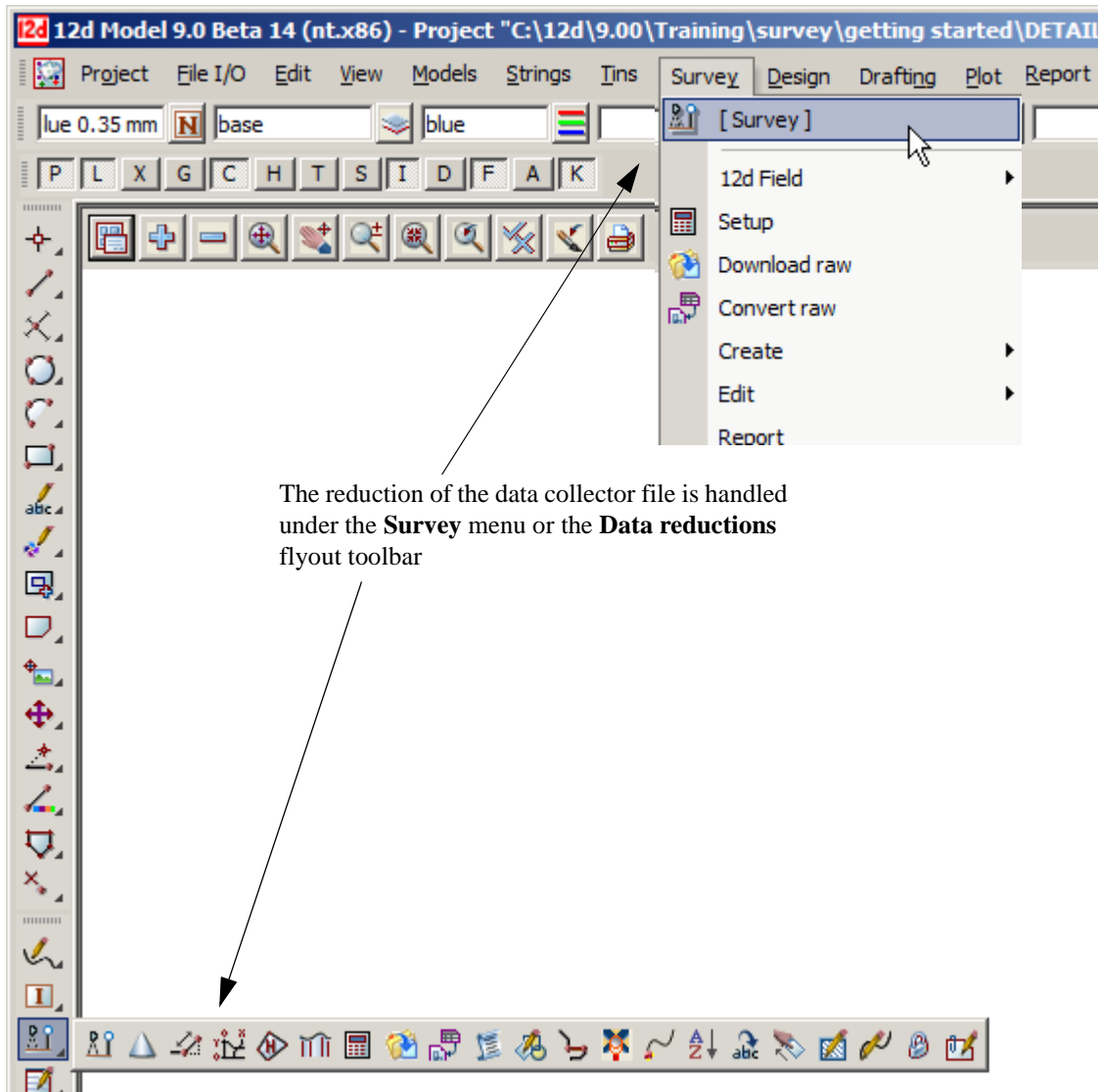

The raw survey data is either

- (a) downloaded from an instrument
- or
- (b) copied to the working folder via a PCMCIA card or other communication package such as *Hyper Terminal*

To allow for a variety of data collectors and coding methodologies, 12d Model allows you to save a user-specified set of data collector parameters away under a user supplied name.

9.4.1 Creating/Checking/Modifying a 12d Data Collector Definition

The data collectors defined within 12d Model include such information as:

- (a) Instrument name, extension for the raw file and vertical circle information.
- (b) Position of the feature code, tinability code and number of digits in the numeric code.
- (c) Delimiters for commands, comments, offset codes, backsight and foresights, check measurements
- (d) Field template codes.
- (e) Communication settings for uploading and downloading.
- (f) Coding for arcs, rectangles, closing strings, pipes and culverts.

Creating new or modifying existing 12d data collectors can be done using option *Project => Tree*, *Survey=>Setup* or by picking the **Survey Setup Data** icon



We will use the option *Project => Tree* for this example

Select the + beside *Survey data collectors* to see the list of existing data collectors.

Double click on **Create data collector** to create a new 12d data collector definition, or double click on an existing data collector in the list to examine or modify it. The **Survey.4d Create/Edit** panel will then appear.

The example below is shown when selecting the **Sokkia String Feature** data collector type

To edit any of the parameters in the **Survey.4d** file select the relevant tab and change the values.

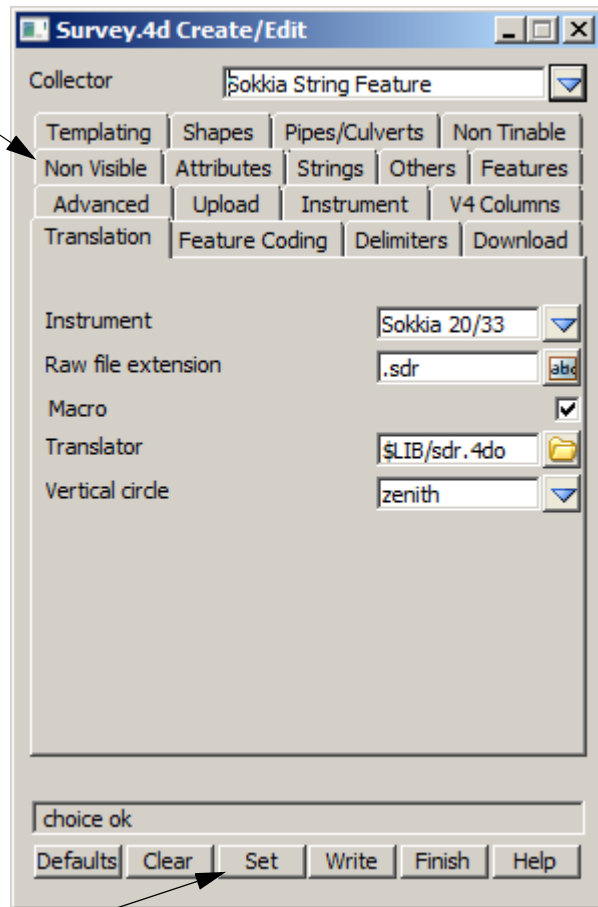

To save the edited file select **Set** then select **Write**

Select **Current folder** to store the file *survey.4d* in the local working folder for use in this project only
Select **Write** then **Finish**

Select **Finish** back in the **Survey.4d Create /Edit** panel

Select **Finish** back in the “**Project Tree**” panel

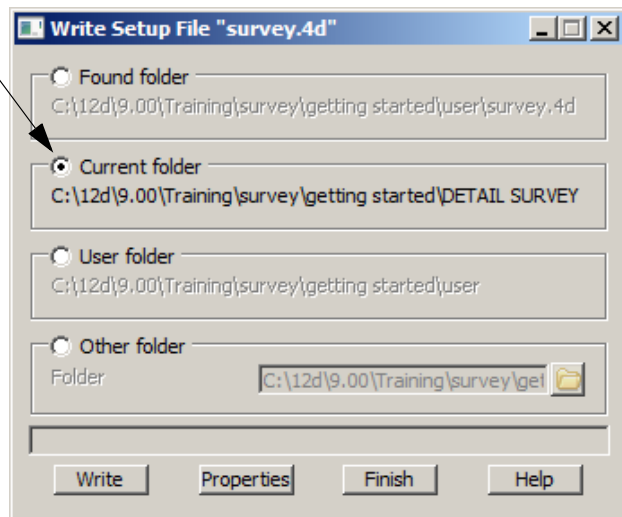

9.4.2 Selecting the Data Recorder type

Select *Survey* => *Setup* or **Survey Data Setup** icon

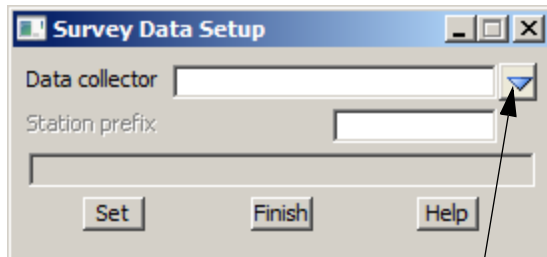

Select the **Data collector** choice icon then double click on the data collector **Sokkia String Feature**

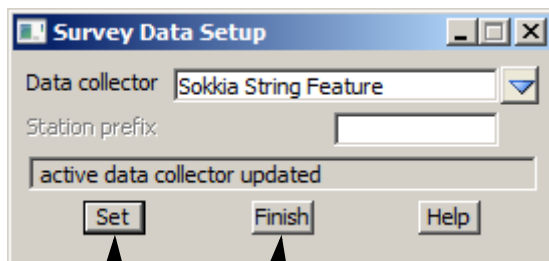
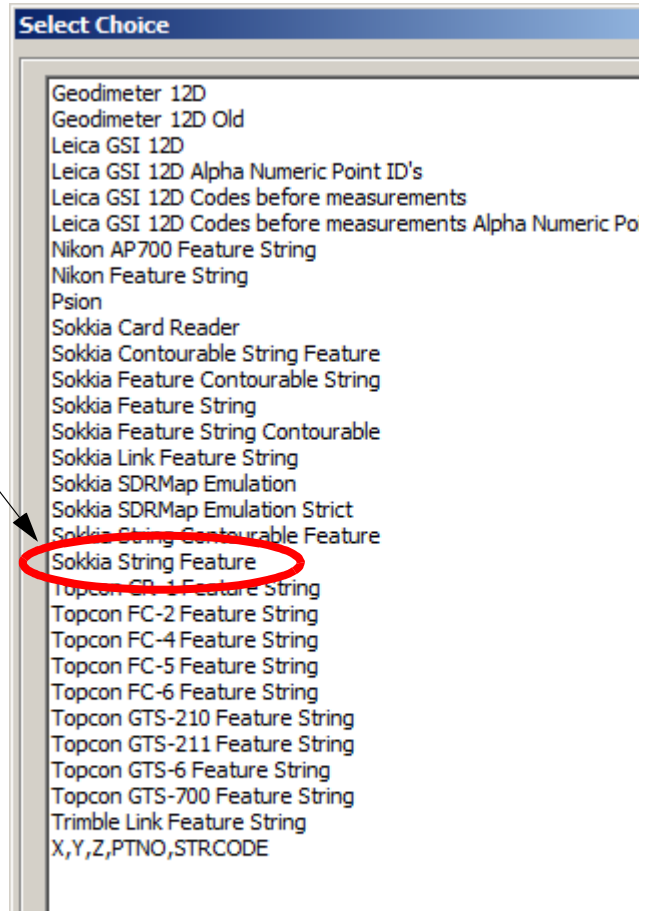

Select *Set* and then *Finish*.

9.4.3 Downloading a Raw Survey File from an Instrument

The raw survey file we require is already on the computer and does not have to be downloaded from a survey instrument.

NOTE - after doing a typical survey job, the raw file for the survey would still be in the data collector and would need to be downloaded using the following procedure:

Select **Survey=>Download Raw** or **Survey Data Download** icon



The values for the communication parameters have come from the data collector definition **Sokkia String Feature**.

If required, the communication parameters can be modified in the panel before commencing the download. For example, the **Port** is the port that you have the data collector connected to.

Type in a name to give the created Field file.

Select **Download** to commence downloading.

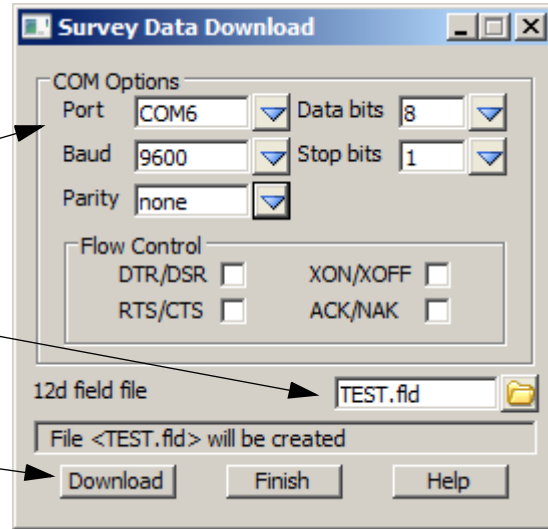

NOTE - you must have a data collector attached to the nominated COM port to be able to download data. The **Comms Capture** panel is automatically placed on the screen to display messages for the download.

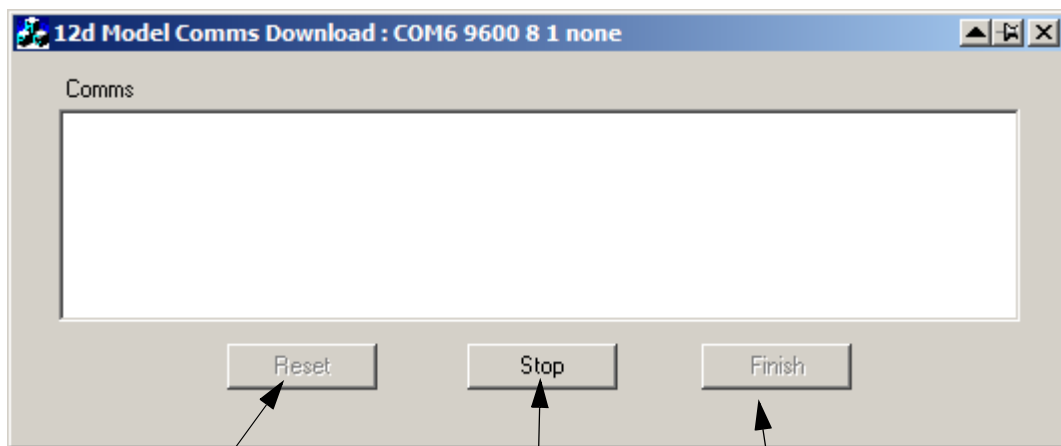

To restart the download press **Reset**

To stop the download press **Stop**

To finish the download select **Finish**

The raw file is downloaded and the field file is created. Both the raw file and the 12d field file are stored in the working folder. In this project the working folder is

C:\12d\9.00\Training\survey\getting started\DETAIL SURVEY

9.4.4 Converting a Raw File to a 12d Field File

If the field data was not downloaded from a data collector then the raw survey data needs to be converted to a 12d Field File before reduction.

For this training example a raw survey data file **DETAIL1.SDR** is already in the **getting started** folder, ready for converting.

However, in real situations, the raw survey data file may have been copied from a PCMCIA or Memory card.

To convert a raw file, select **Survey=>Convert Raw** or **Survey Data Convert raw** icon

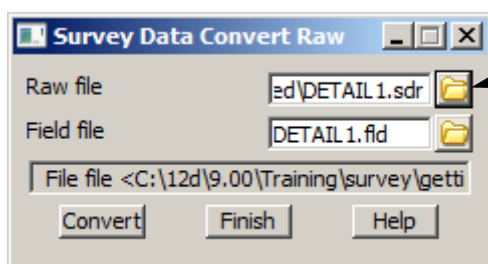

Click on the **Raw file** folder icon

Browse up a level to folder

C:\12d\9.00\Training\survey\getting started
and select the file **DETAIL1.sdr**.

The field file name **DETAIL1.fld** will automatically be filled in or can be user defined.

To create the field file select **Convert** then **Finish**

This will convert the raw Sokkia file to the 12d Field File format ready for reduction.

Note: The list of raw survey files are expected to have the extension **".sdr"** as specified in the data collector definition **Sokkia String Feature**. It is recommended that any files manually copied to the working folder have the correct extension.

9.4.5 Running the Survey Data Reduction Function

Select *Survey => Create => Field File* or select **Survey Data Reduction Function** icon

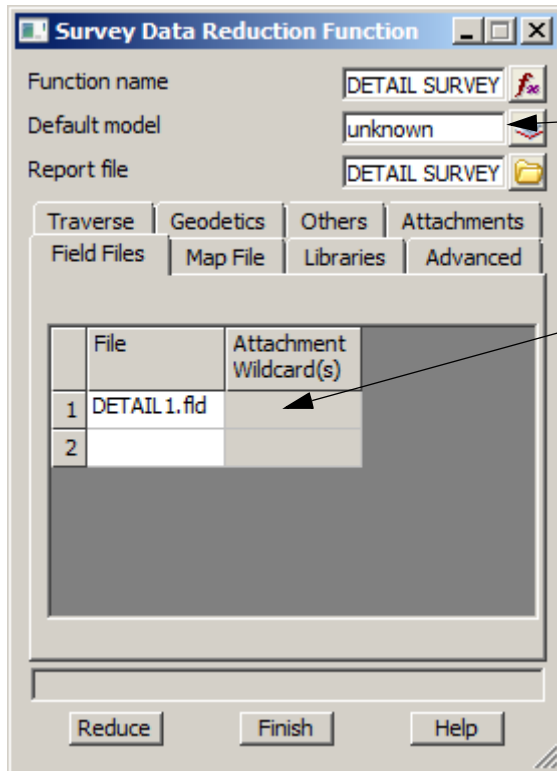

Type in the Function name **DETAIL SURVEY**

Type in **unknown** for the model name for strings that have unrecognised feature codes.

Type in report file name **DETAIL SURVEY** (when pressing [Enter] the file is given the extension **.rpt**).

Under the **Field Files** tab the newly created field file **DETAIL1.fld** is displayed as the default

Map file tab

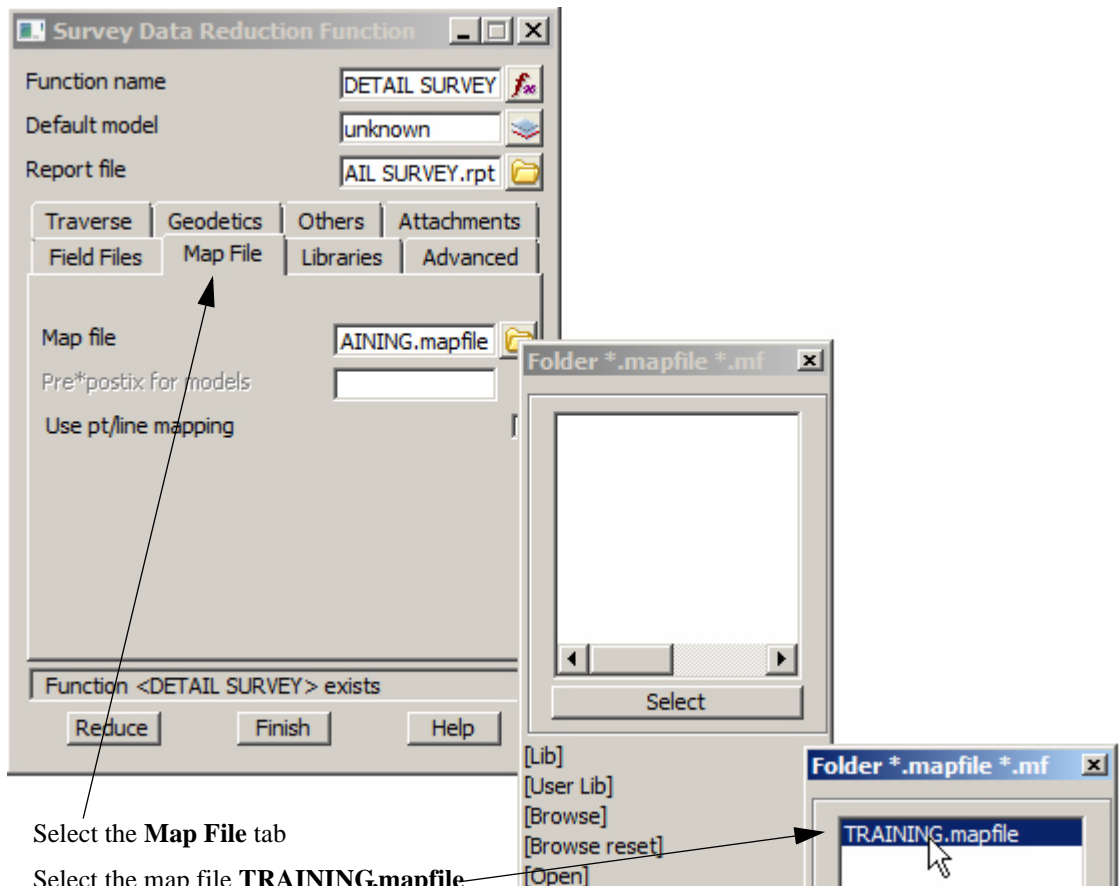

Select the **Map File** tab

Select the map file **TRAINING.mapfile** from the User_lib folder. This will be used to map the survey readings to their correct model and other features.

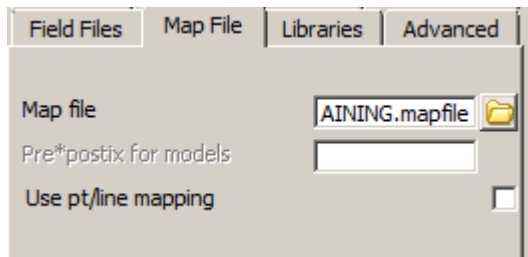

The reduced data can be separated from other surveyed data by using a prefix which goes in front of any model name created using the mapping file.

Advanced tab

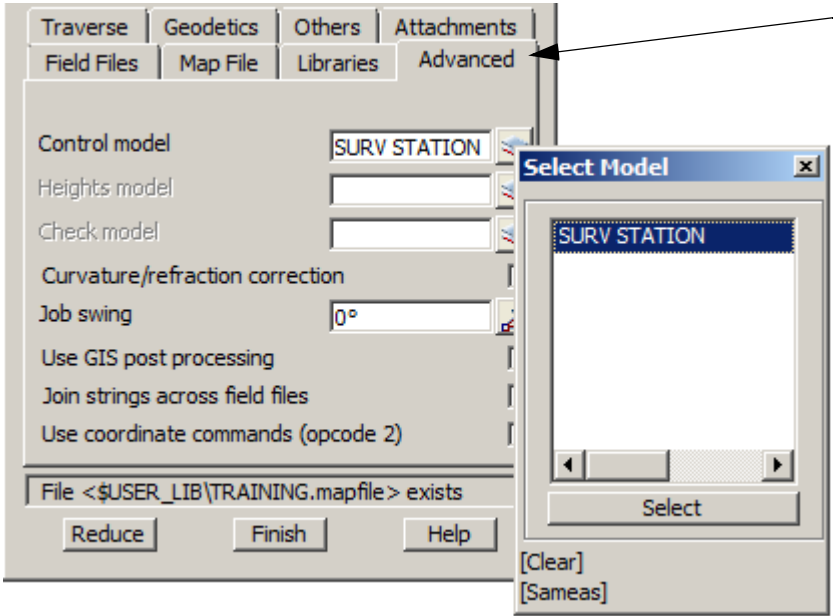

Select the **Advanced** tab

12d can either reduce the survey readings from station information within the field file or by specifying the model containing the survey station points. In this case we have read survey points existing in the project.

Select the **Control model** choice icon

Double click on the model name **SURV STATION**

Others tab

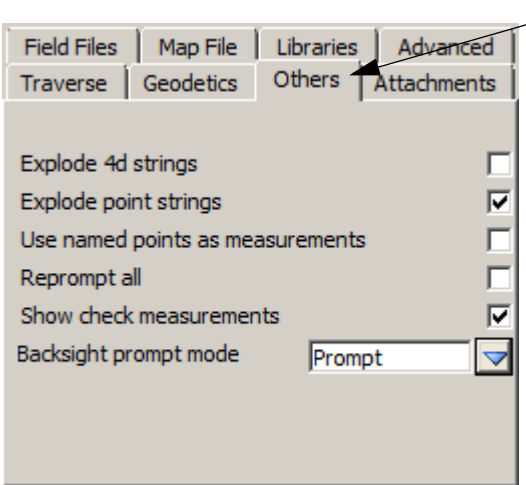

Select the **Others** tab

Tick **Explode point strings** check box to ensure individual survey points are kept separate from other points with the same code

Tick **Show check measurements** check box to display check measurements during the reduction

Select the **Backsight prompt mode** choice icon and select **Prompt** to pause the reductions as each backsight reading is reduced

Reduce the function

Select **Reduce** to reduce the field file

Each time a Backsight measurement appears in the reduction a **Bearing Datum Difference** panel is displayed.

The user has a number of possible responses

Yes will apply the swing to the following readings until the next bearing difference panel appears

Yes to all will apply the swing to the following readings and bypass all following panels using yes as the default.

This is not a good idea unless the file is being re-reduced

No will apply no swing to the following readings until the next bearing difference panel appears

No to all will apply no swing to the following readings and bypass all following panels using no as the default.

This is not a good idea unless the file is being re-reduced

Edit is used to activate the field file to view the reading to the backsight point. This is useful if the wrong backsight point ID is entered. The new ID can be edited and the reduction continued

Cancel is used if there is a major problem with the reductions and the process has to be terminated in order to fix the error.

Note: By pressing Cancel the process stops at that point in the reduction and an incomplete survey may appear in the graphics

You have to rereduce the survey after pressing Cancel

For this exercise select **Yes**

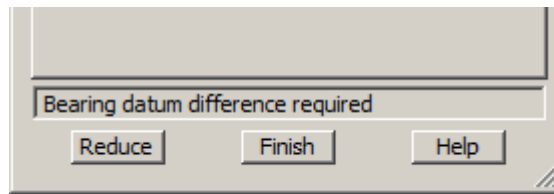

Bearing Datum Difference

Station name: 901
Backsight name: 902

	Observed	Calculated	Observed - Calculated	Corrected	Corrected - Calculated
Easting	42801.561	42801.558	0.003	42801.561	0.003
Northing	36989.254	36989.254	-0.000	36989.254	-0.000
Height	174.506	174.520	-0.014	174.506	-0.014
Bearing	96° 29' 9"	96° 29' 9"	- 0° 0' 0"	96° 29' 9"	0° 0' 0"
Distance	286.712	286.709	0.003	286.712	0.003

Horizontal collimation:

Vertical collimation:

Apply Swing:

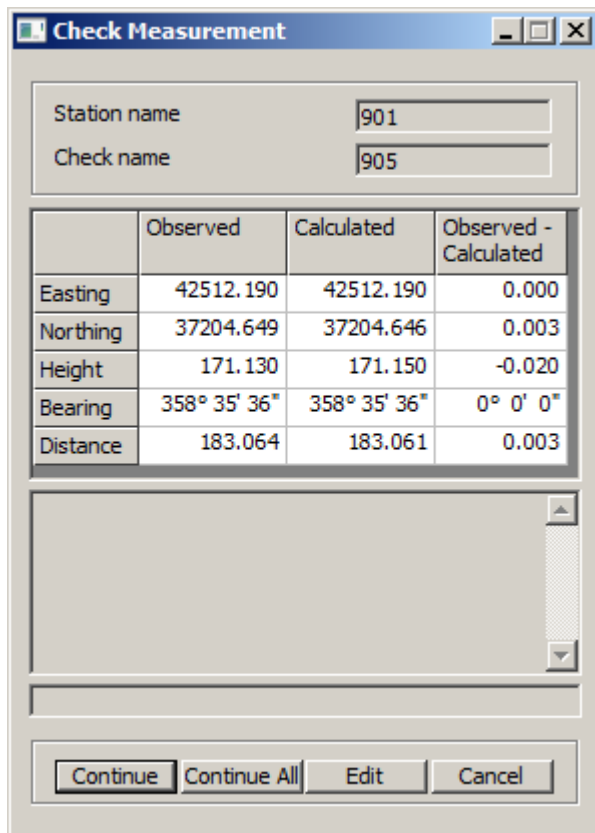

If check readings are taken to known points a **Check Measurement** panel is displayed

Again the user has a number of possible responses

Continue will close the panel and the processing continues until the next check reading is encountered

Continue all will close the panel and the processing continues with all following check measurement panels not displayed

This is not a good idea unless the file is being rereduced

Edit is used to activate the field file to view the check reading to the point. This is useful if the wrong check point ID is entered. The new ID can be edited and the reduction continued

Cancel is used if there is a major problem with the reductions and the process has to be terminated in order to fix the error.

Note: By pressing Cancel the process stops at that point in the reduction and an incomplete survey may appear in the graphics

You have to rereduce the survey after pressing Cancel

For this exercise select **Continue** each time the panel appears.

NOTE - When the survey data is being reduced, the **Bearing Datum Difference** panel and **Check Measurement** panels come up a number of times.

When the reduction is finished **don't** press Finish until the report file has been checked for errors

9.4.6 Checking the Report File for Reduction Errors

We will now check the report for any errors found by the reduction process. This should be done prior to any other editing

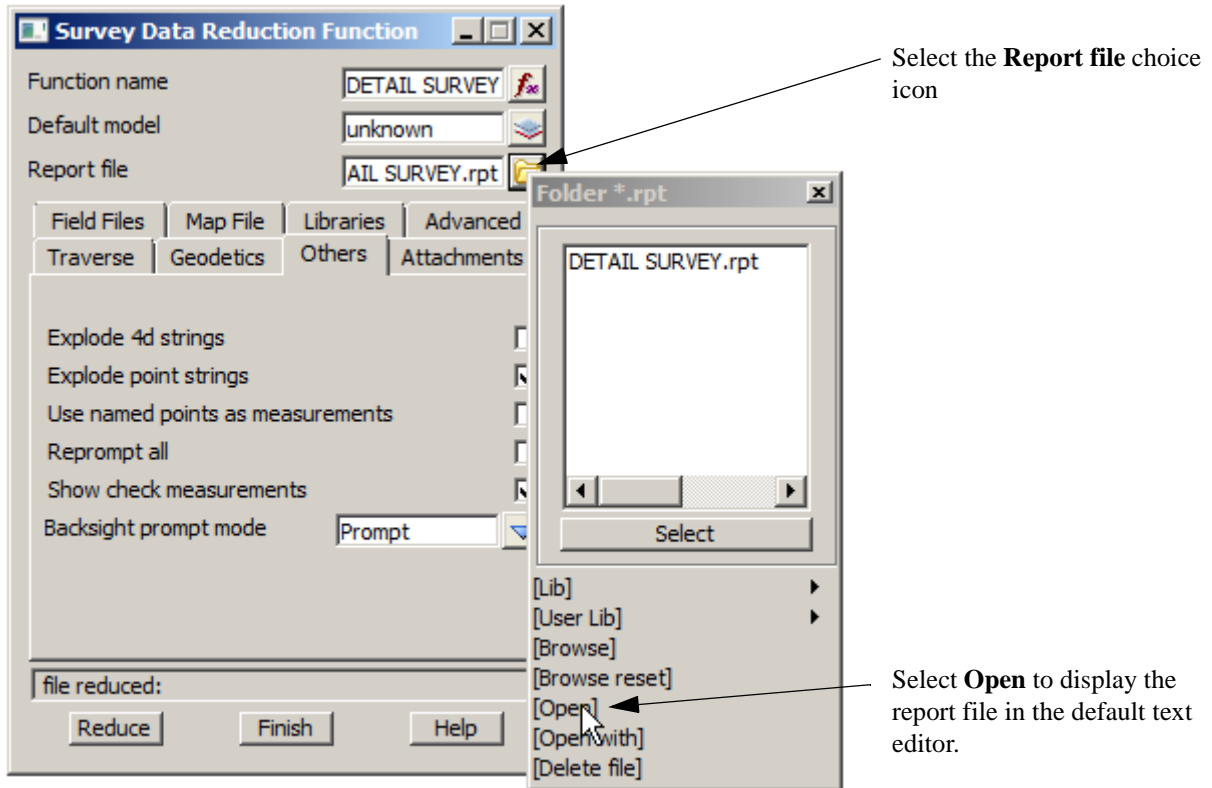

If the Survey Data Reduction Function panel has accidentally been closed the file can be loaded into the text editor by selecting option **Reports** => **Edit** or **Edit a file *.rpt** icon

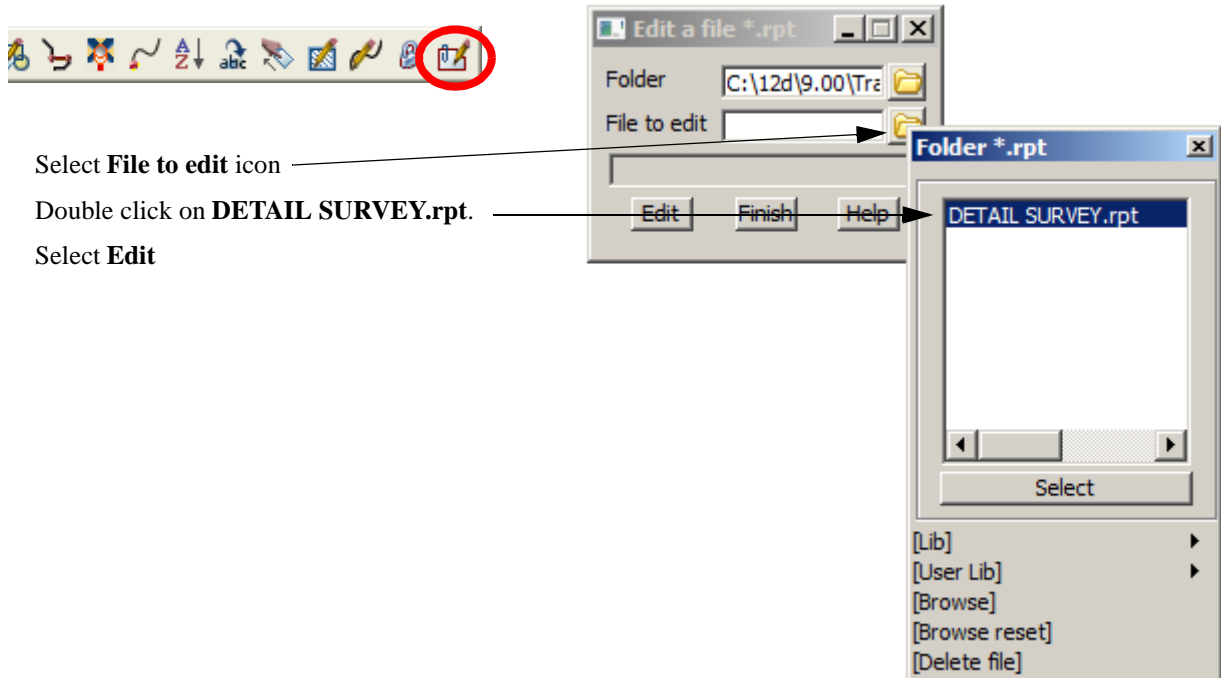

The file **DETAIL SURVEY.rpt** will then displayed in the default text editor.

```

C:\12d\9.00\Training\survey\getting started\DETAIL SURVEY\DETAIL SURVEY.rpt
0 10 20 30 40 50 60 70 80
1 Survey Data Reduction
2 =====
3
4 Reduction report for field files
5 --DETAIL1.fld
6
7 New scale factor 1.00000000
8 Memo: Current view .....
9 Memo: 10000 .....
10 Memo: P.C. mm Applied: 0.000 .....
11 Coordinate for station "901" defined from control model "SURV STATION->STN"
12
13 Occupying Station .....: 901
14 Coordinates .....: E 42516.684 -- N 37021.640 -- H 207.000
15 Code .....: STN
16 Instrument Ht .....: 1.565
17
18 Coordinate for Backsight "902" defined from control model "SURV STATION->STN"
19 ..... 96° 29' 9" -- 96° 27' 37" 288.543 -- 1.600 -- 42801.561 -- 36989.254 -- 174.506
20
21 ***** Backsight to "902" Code "STN" *****
22
23 ..... OBSERVED ..... CALCULATED ..... OBSERVED - ..... CORRECTED ..... C
24 ..... (SWUNG) ..... CALCULATED ..... C
25 EASTING ..... 42801.561 ..... 42801.558 ..... 0.003 ..... 42801.561 .....
26 NORTHING ..... 36989.254 ..... 36989.254 ..... -0.000 ..... 36989.254 .....
27 HEIGHT ..... 174.506 ..... 174.520 ..... -0.014 ..... 174.506 .....
28 BEARING ..... 96° 29' 9" ..... 96° 29' 9" ..... 96° 29' 9" .....
29 DISTANCE ..... 286.712 ..... 286.709 ..... 0.003 ..... 286.712 .....
30
31 Bearing datum difference --- 0° -- 0' -- 0" applied to subsequent measurements
32
33 Coordinate for Check measurement "905" defined from control model "SURV STATION->STN"
34
35 ***** Check Measurement to "905" Code "" *****
36
37 ..... OBSERVED ..... CALCULATED ..... OBSERVED -
38 ..... CALCULATED
  
```

Scroll down through the report file checking for any problems or errors.

At the end of the file is the list of **Unknown Feature Codes**.

These are the feature codes that appeared in the field file **DETAIL1.fld** but were not in the mapping file

```

(659 measurements)
Count Unknown Feature Codes
-----
1 PUMP
1 TBK
End of reduction report
  
```

PUMP and **TBK** were codes found in the field file **DETAIL1.fld** but not in the mapping file **TRAINING.mapfile**.

PUMP is the feature code for a water pump.
TBK was entered in error for the code **TBL**

Quit from the text editor.

9.4.7 Editing the Map File

We will now add the missing feature code **PUMP** into the map file.

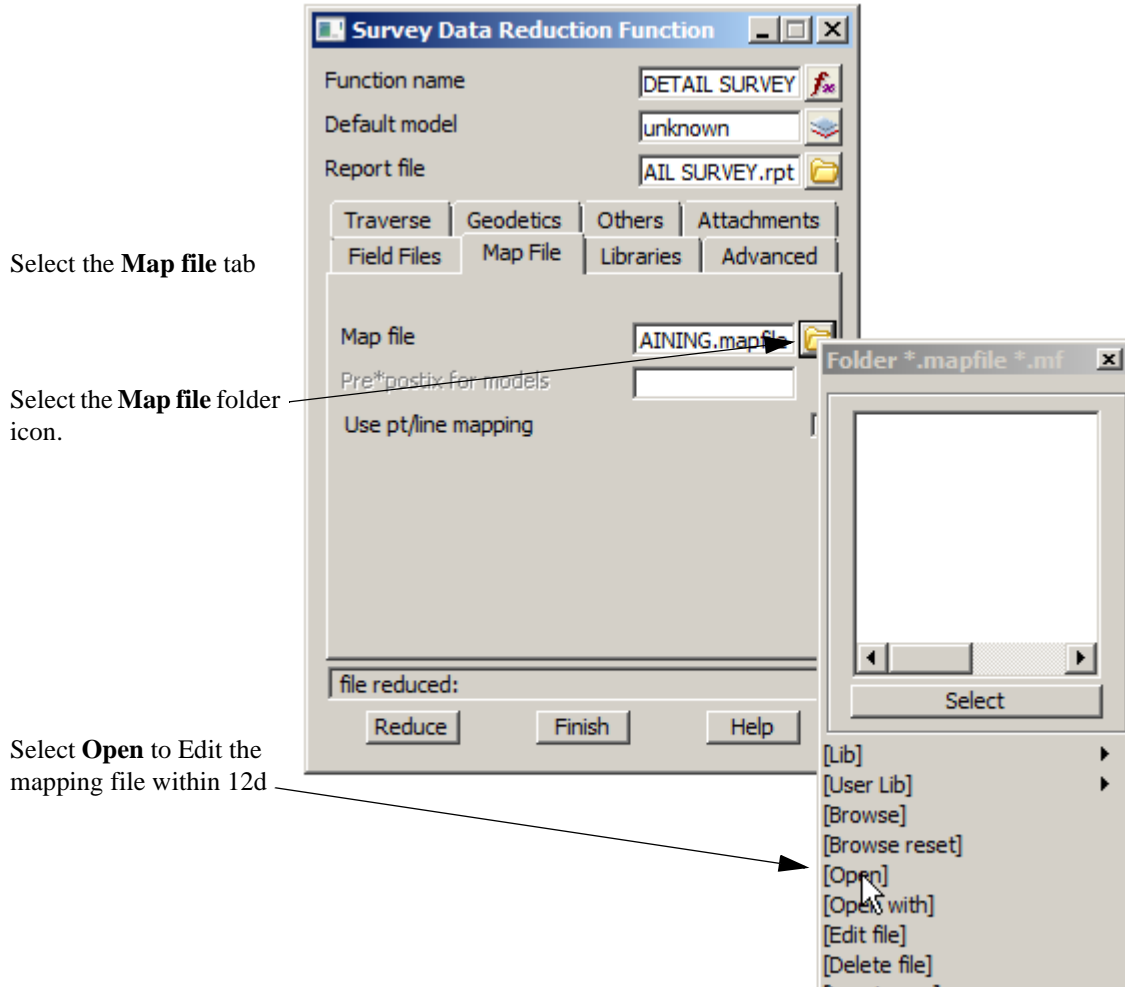

The interactive map file editor will then start up with the mapping file **TRAINING.mapfile** loaded.

If the **Survey Data Reduction Function** panel is not on the screen, the map file editor can be brought up by selecting **File I/O=>Map file** or by selecting **Survey Data Reduction Function** icon



We can also find the function by walking right on **Editor** on the **Recalc** panel

Click on the **Map file** folder icon

Select the map file **TRAINING.mapfile** from the **User_lib** folder.

Click on **Read** to load the map file into the editor.

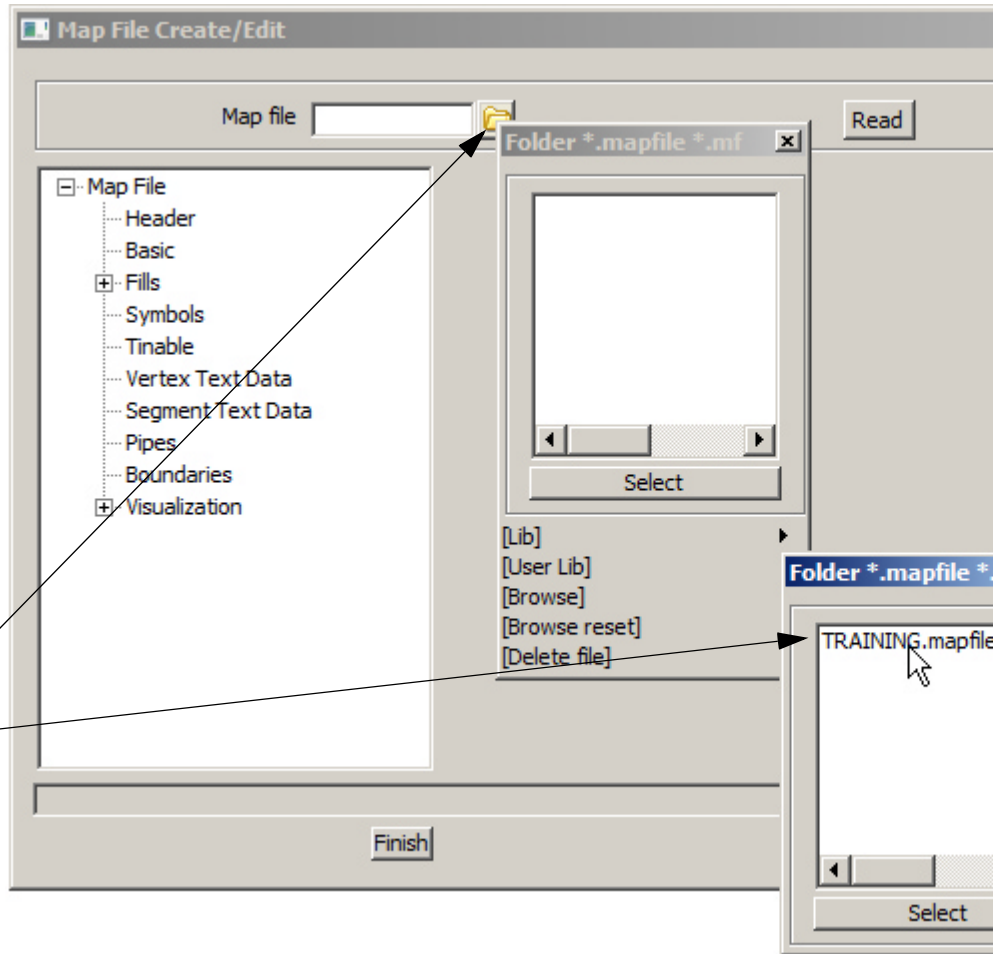

The interactive map file editor with the mapping file **TRAINING.mapfile** loaded looks like:

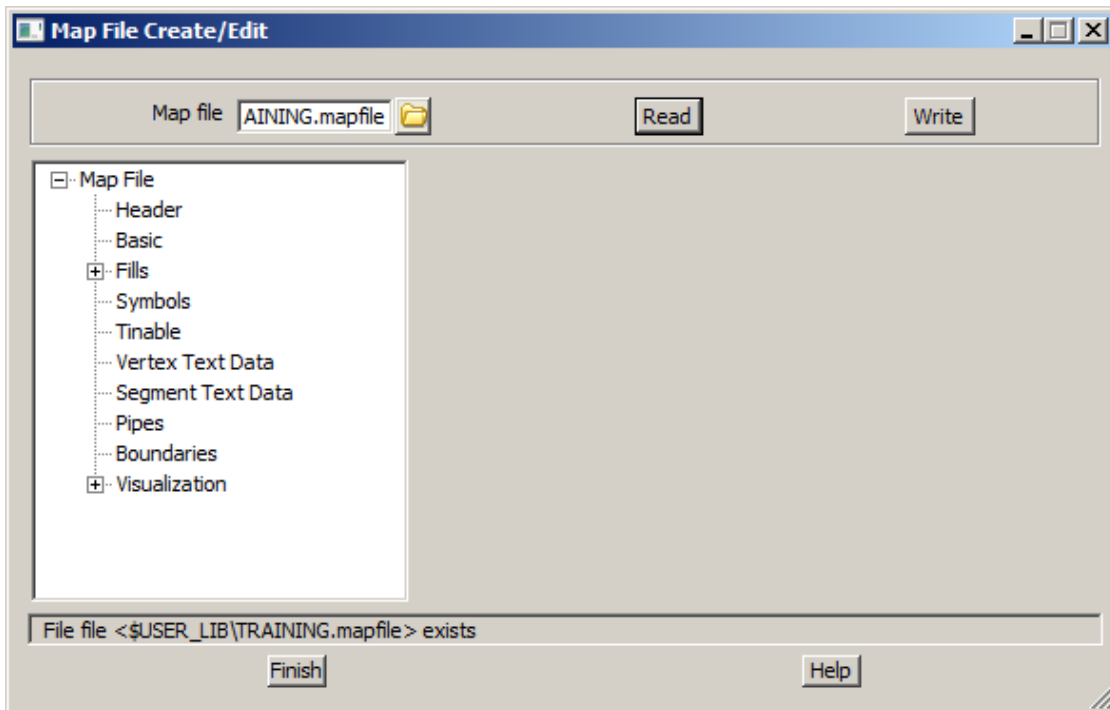

We will now add the feature code **PUMP** to as many tables as required.

PUMP is to be a point type string with a symbol at the vertex and is to be placed in the model **WATER PUMP** with colour **cyan**, linestyle **0** and symbol **DS SC**.

The point **PUMP** is not to be included in the triangulation (Tin).

Basic code

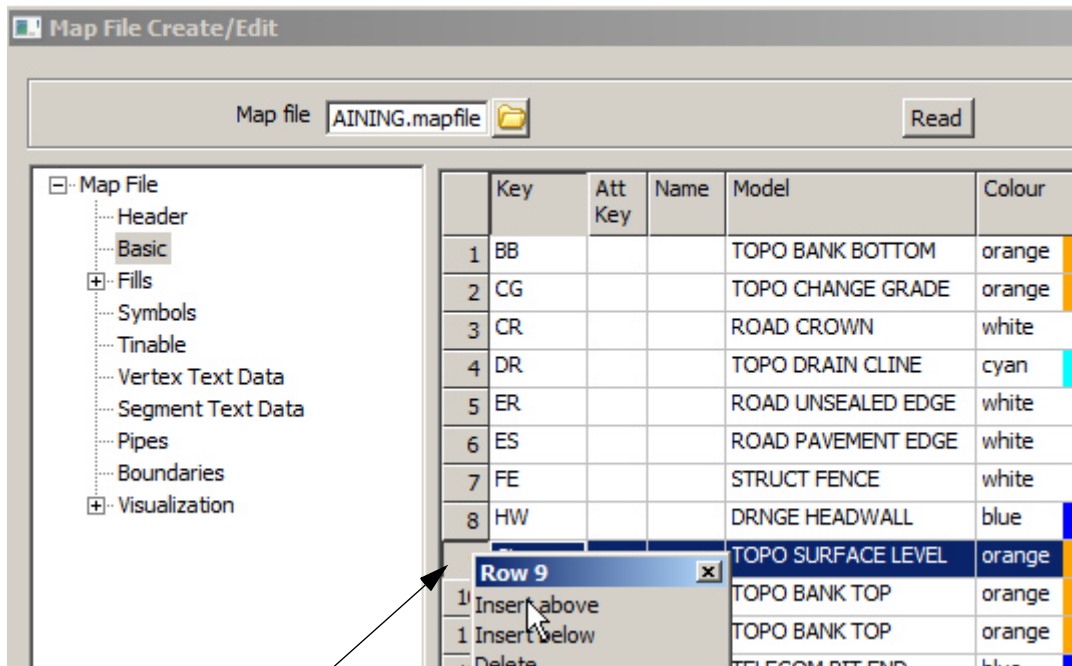

Select **Basic** tab

Scroll down to the line you wish to insert the new feature code above.

Click Right button on the line number **9** and select **Insert above** from the panel.

A blank line is inserted and the rest of the lines move down.

7	FE		STRUCT FENCE	white	line	DS FE	
8	HW		DRNGE HEADWALL	blue	line	1	
9							
10	SL		TOPO SURFACE LEVEL	orange	point	0	
11	TBL		TOPO BANK TOP	orange	line	DS TBL	
12	TBR		TOPO BANK TOP	orange	line	DS TBR	
13	TEL		TELECOM PIT END	blue	line	0	

	Key	Att Key	Name	Model	Colour	Point Line	Linestyle	Weight	Comment
8	HW			DRNGE HEADWALL	blue	line	1		HEADWALL
9	PUMP			WATER PUMP	cyan	point	0		WATER PUMP
10	SL			TOPO SURFACE LEVEL	orange	point	0		SURFACE LEVEL

Type **PUMP** into the Key column.

Type **WATER PUMP** into the Model column.

Right click in the Colour icon and select **cyan**.

Right click in the Point column and select **Point** as the **PUMP** is a point feature.

Type in **0** in the Linestyle column as the point will have a symbol only and this will be applied in another section

Type the description **WATER PUMP** in the Comment column.

Tinability

Select the **Tinable** branch

The tinable parameters define whether the points and/or segments of a string are used in a triangulation.

Note: Data in 12d is tinable by default so the tinable option **yes** is optional

The choice for the tinable flag are:

- no** for points and segments non tinable (points are not used when triangulating and strings are not breaklines)
- yes** for points and segments tinable (points are used when triangulating and strings are breaklines)
- points** for points tinable but segments non tinable (points are used when triangulating but strings not breaklines)

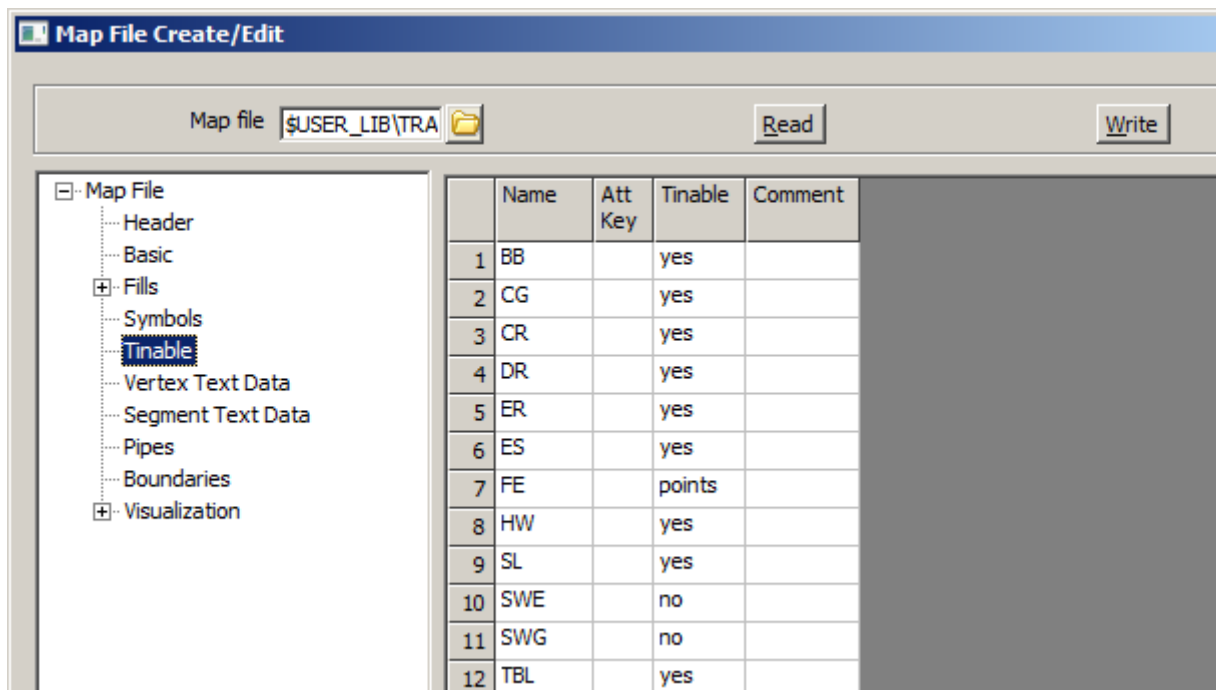

Note that it makes no sense to have points not tinable and segments tinable, so that case doesn't exist.

Editing the *Tinable* tab is similar to editing the *Basic* tab.

Click Right button on the line number 9 and select **Insert above** from the panel.

Type in **PUMP** into the Key column.

Since **PUMP** is a non-tinable point symbol, select **no** for the Tinable type.

7	FE	points	
8	HW	yes	
9	PUMP		
10	SL	yes	
11	SWE	no	
12	SWG	no	
13	TBL	yes	

Symbol

Explode the **Symbols** branch then select **String**.

Add a new line as shown under the Basic tab

The screenshot shows the 'Map File Create/Edit' dialog box. On the left, a tree view shows the 'Map File' structure with 'Symbols' expanded to 'String'. The main table lists symbols with columns for Name, Att Key, Symbol, Hide vertex, and Comment. Row 9 is highlighted with 'PUMP' in the Name column. A 'Symbol Information' dialog box is open over row 9, showing fields for Symbol (DS SC), Colour (blue), Size (2), Rotation (0°), Offset (0), and Raise (0). Buttons for 'Set', 'Sameas', 'Clear', and 'Finish' are at the bottom of the dialog. A 'Finish' button is also at the bottom of the main dialog. An arrow points from the text 'Double click on the Symbol cell' to the 'Symbol' cell in row 9 of the main table.

Name	Att Key	Symbol	Hide vertex	Comment
1	BB	DS POINT CROSS ...	no	
2	CG	DS POINT CROSS ...	no	
3	CR	DS POINT CROSS ...	no	
4	DR	DS POINT CROSS ...	no	
5	ER	DS POINT CROSS ...	no	
6	ES	DS POINT CROSS ...	no	
7	FE	DS POINT CROSS ...	no	
8	HW	DS POINT CROSS ...	no	
9	PUMP			
10	SL	DS POINT CROSS ...		
11	TBL			
12	TBR			
13	TR0406			
14	TR0804			
15	TR0806			
16	TR0814			
17	WL			
18				
19				

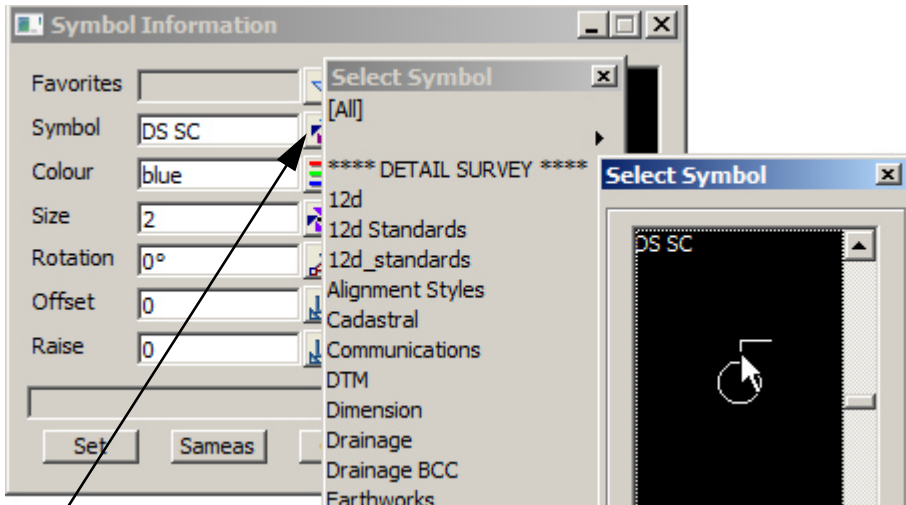

Select the Symbol icon

Walk right on the **DETAIL SURVEY** group and click on **DS SC**

Change the colour to **blue**

Type in the size **2**. This symbol is in drawing units so 2 represents a size of 2 plot millimetres

Click on [**Set**] then [**Finish**]

Right click on Hide Vertex column then select **no**

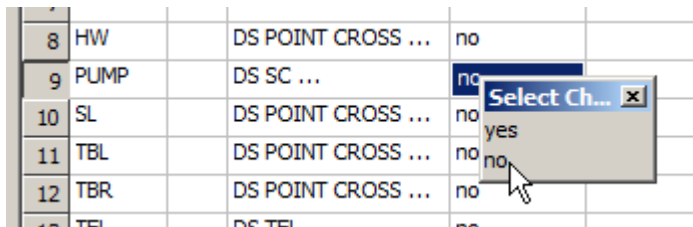

Select **Write** to update the map file.

Select **Replace** to overwrite the existing file

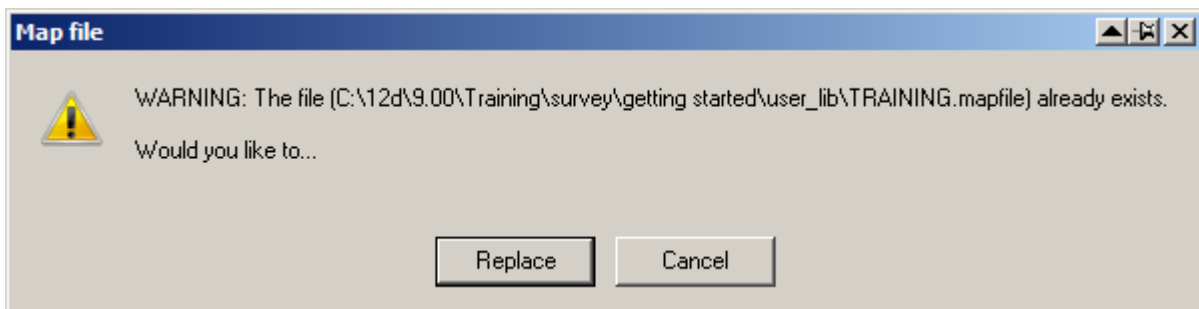

Select **Finish** to exit the map file editor

9.4.8 Re-Running the Survey Data Reduction Function

Now that the mapping file has been changed, the 12d field file **DETAIL1.fld** needs to be re-reduced.

If the **Survey Data Reduction Function** panel is not on the screen, it can be brought up again by selecting the option **Survey=>Create=>Field file** or by selecting **Survey Data Reduction Function** icon



We can also find the function by walking right on **Editor** on the **Recalc** panel

Click on the **Function name** icon and double click on the function **DETAIL SURVEY**.

All of the parameters previously entered for that function will be loaded into the panel.

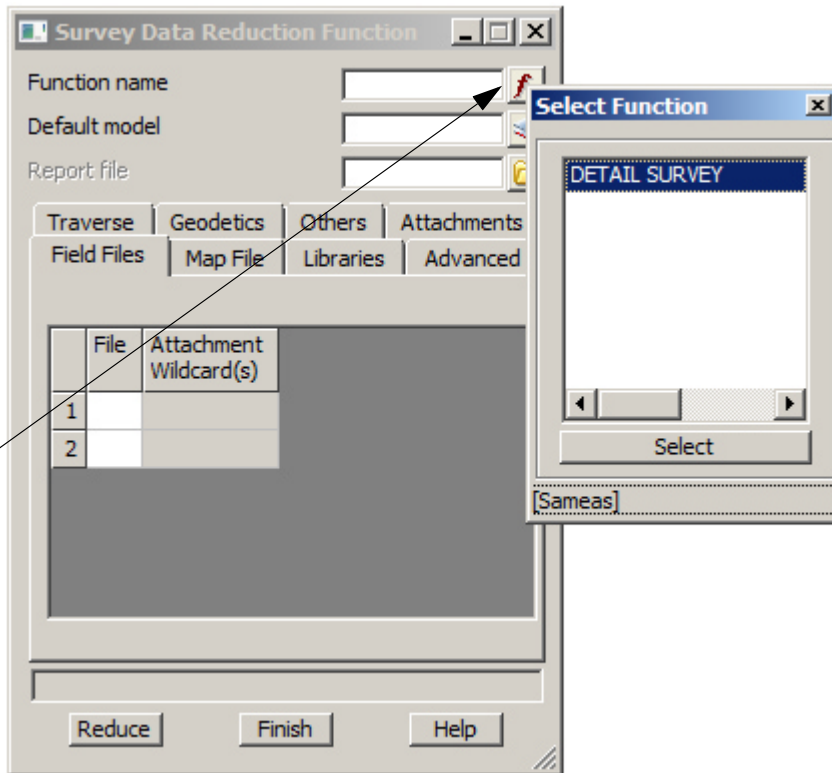

If the Survey Data Reduction Function panel is still on the screen no entry is required

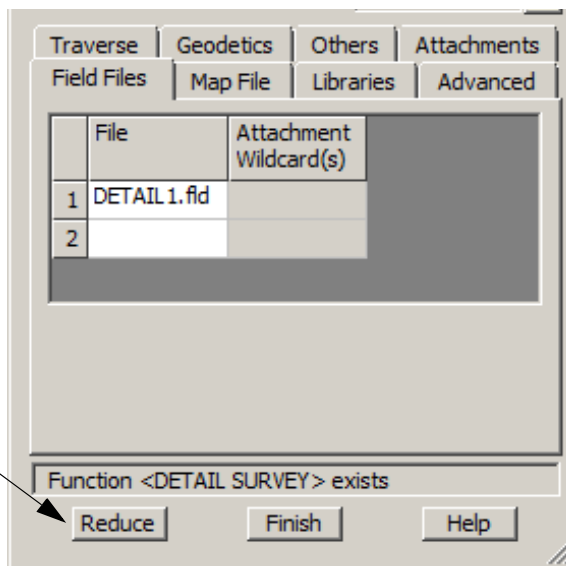

For both cases, simply click on **Reduce**

This re-reduces the field file **DETAIL1.fld** using the modified map file **TRAINING.mapfile** and updates the report file.

Open the report file again to ensure the code **PUMP** is not an Unknown feature code. The code **TBK** will still be listed as unknown. We will fix this later.

After the report file has been closed, the **Survey Data Reduction Function** panel can be **Finished**

9.5 Graphically Editing the Field File Data

The detail survey can be edited graphically whilst maintaining a dynamic link to the field file and the resulting report file. This ensures that if the field file is re-reduced any changes will be maintained.

As the manuals are produced with the view background colour as white string colours may appear different to those on your screen

9.5.1 View the Survey Data

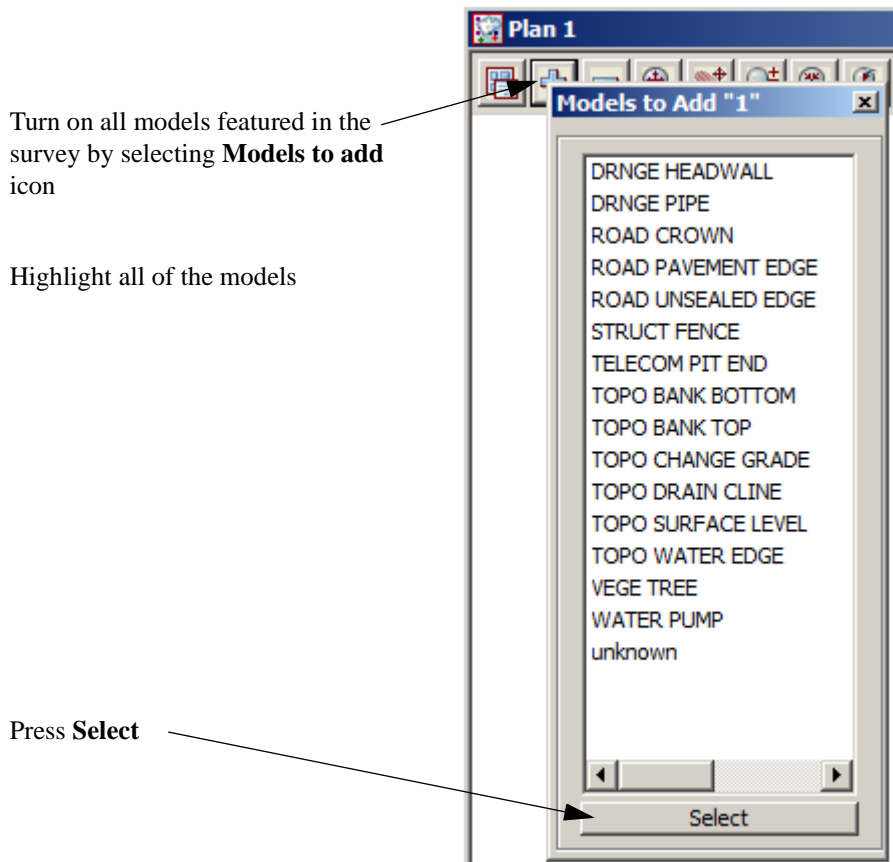

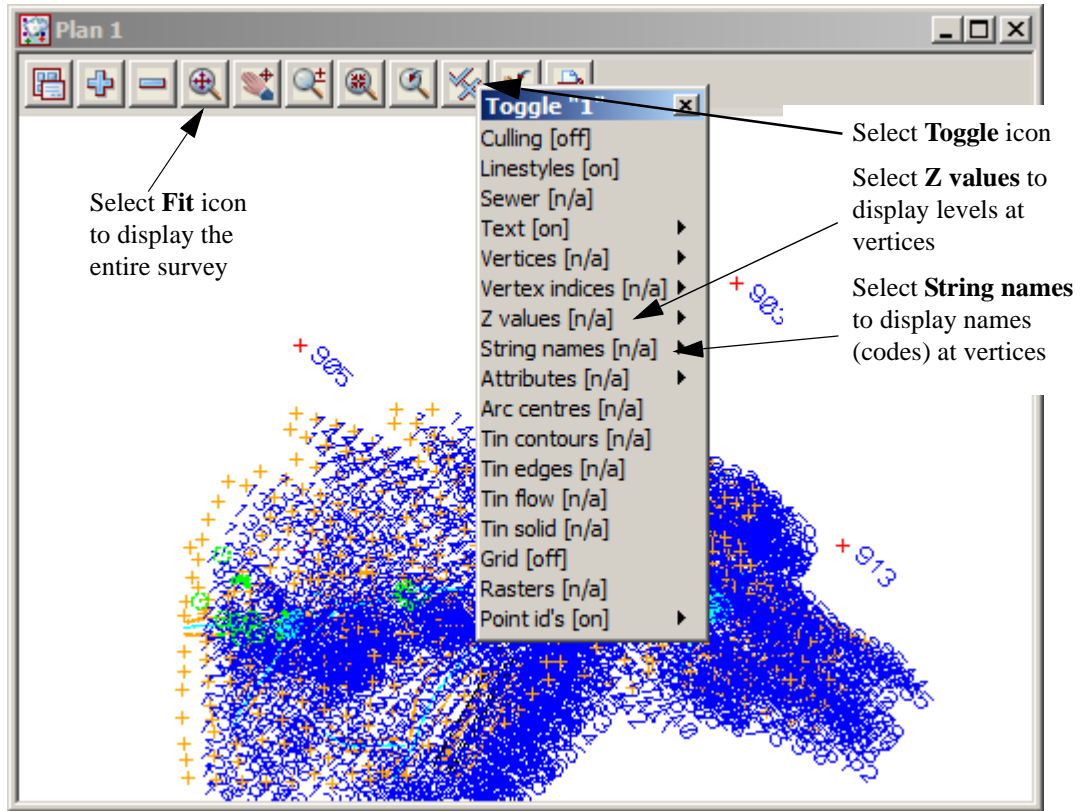

With all the text turned on, the survey is hard to read

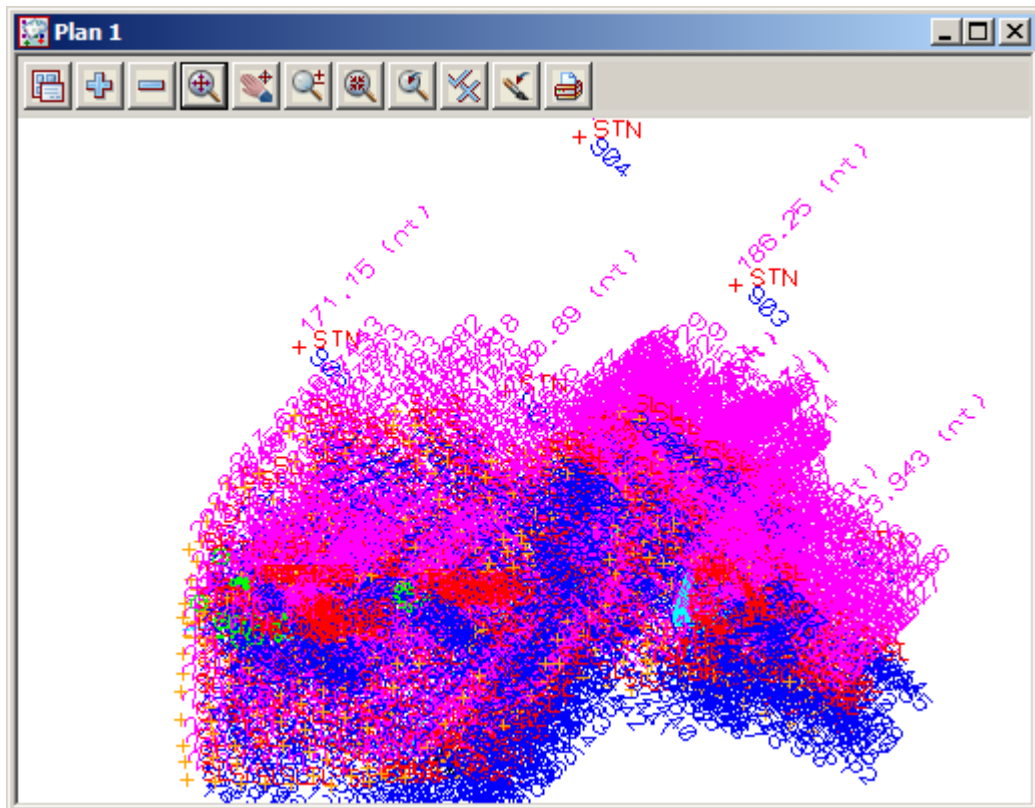

The toggled text can be given user defined settings to allow the text to be viewed only when zoomed in to a preset scale.

9.5.2 Setup your text screen settings

Zoom into an area with a lot of text displayed

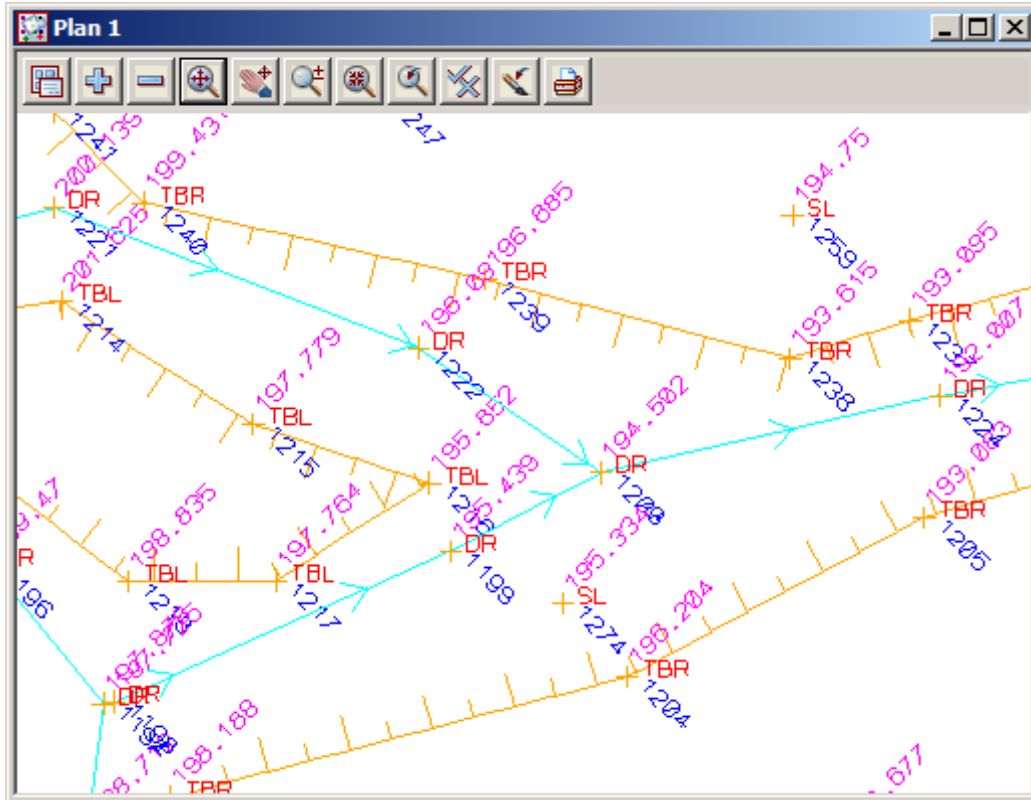

Walk right on **Menu=>Settings=>Z Values**

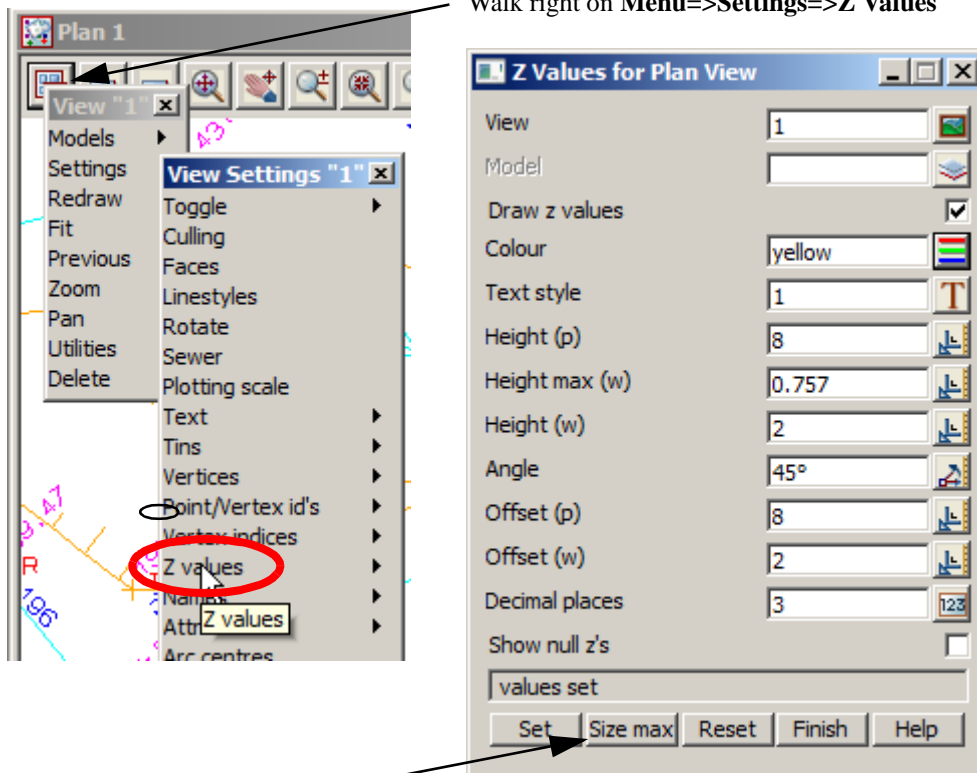

Select **Size max**, **Set** and then **Finish** to set default Z value height to that shown on the current screen
 Roll the wheel in and out to see the effect

Repeat this process for Names using option *Menu=> Settings =>Names => Single*

Now zoom out to a scale to define the point number display

Select *Menu=> Settings =>Point/Vertex Id's=>Single*

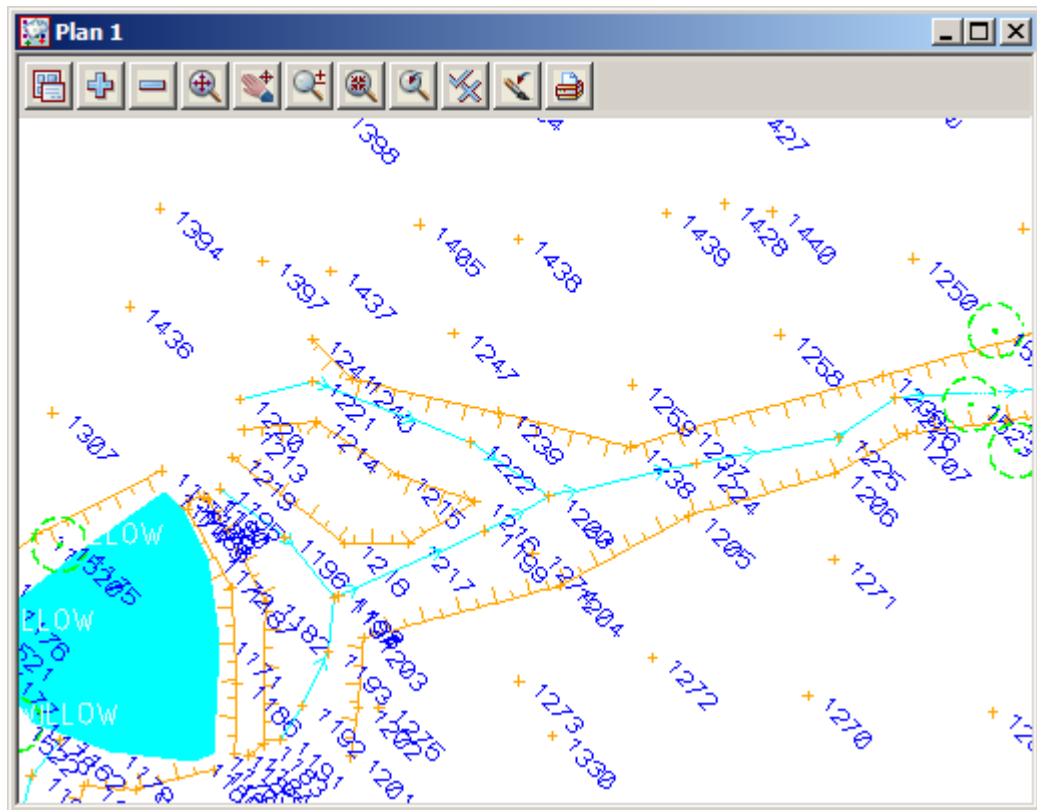

Set the point id scales

Now zoom all of the survey for an easily readable screen

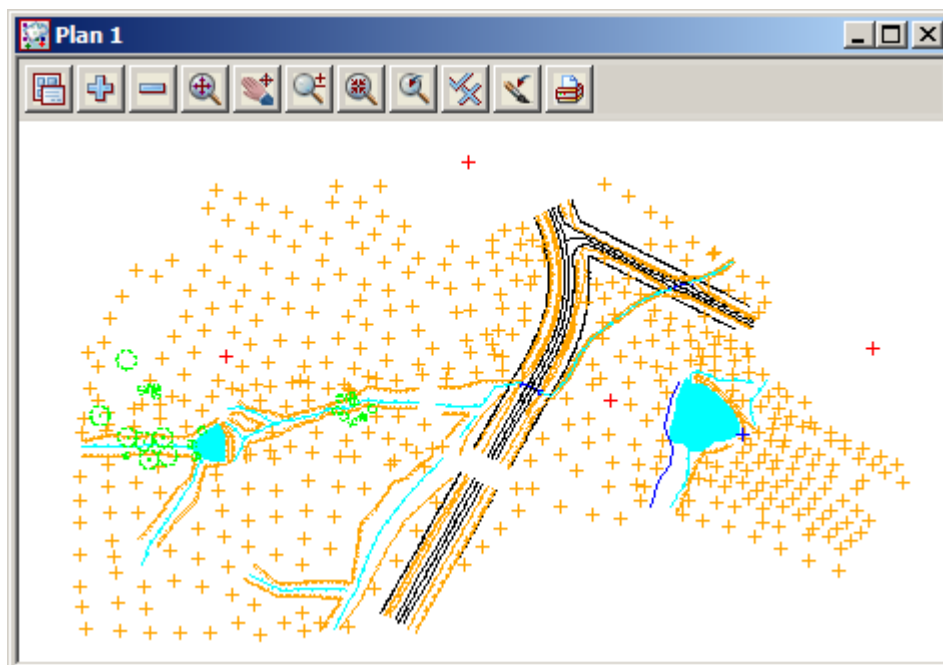

9.5.3 Graphically Editing the Field File Data

As we move along the survey, errors are detected and need to be changed in the field file if possible.

There are options that can edit both the graphics and the field file but update the field file reduction after these edit

The Graphical edits are selected from the *Survey=>Edit* menu, the **Detail Survey reductions** flyout toolbar on the cad toolbar



Tiling field file editor with plan view

Open the field file editor using option *Survey=>Edit=>Field data* or select **Edit field file** icon



Place the field file editor on the left side of the screen with the plan view 1 on the right

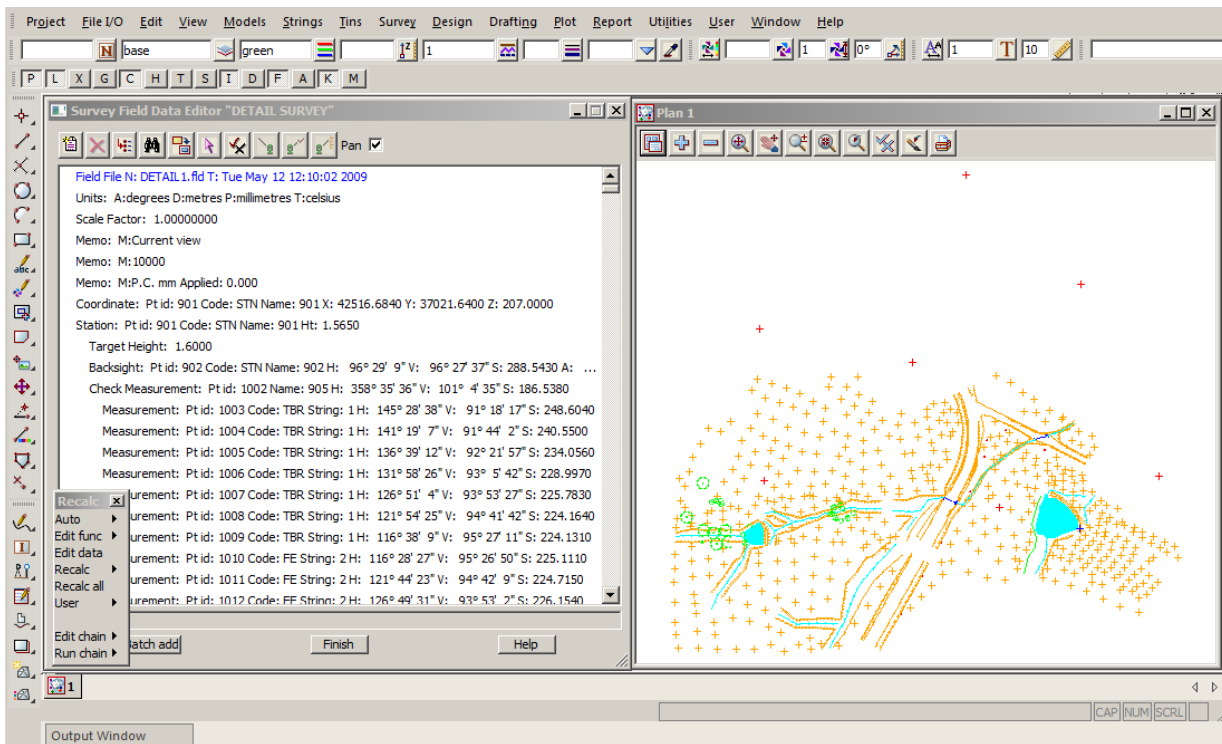

The advantage of having the field file editor active when editing the survey is the ability to reset any edits that are performed either graphically or directly into the field file editor.

Field file editor link to graphics

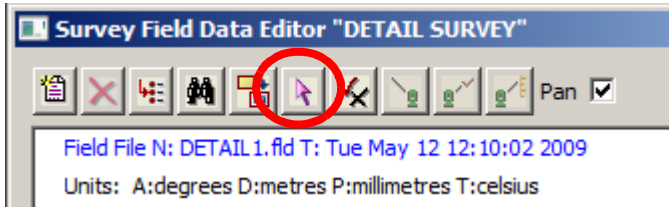

The pick icon shown above can be used to select a point in the graphics and if the point is associated with the field file function being edited then the relevant measurement line will be highlighted

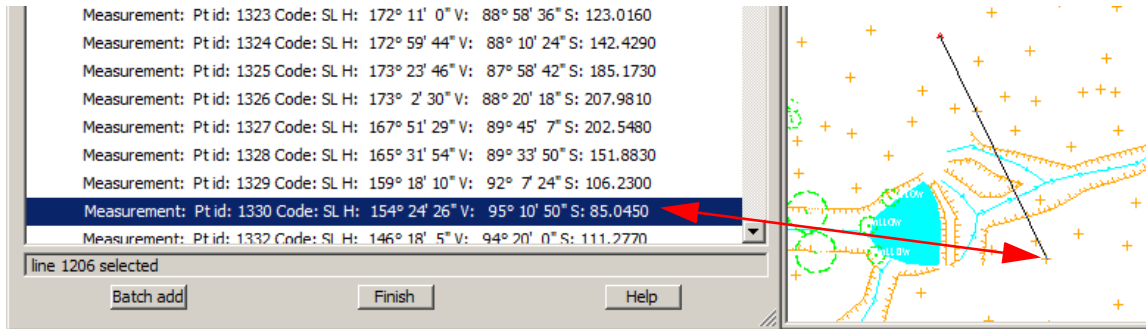

Alternatively once the Pick icon has been selected the point number can be typed in manually. This can be done by either typing in the point number or pressing [space] bar to activate the input panel then typing in the point number.

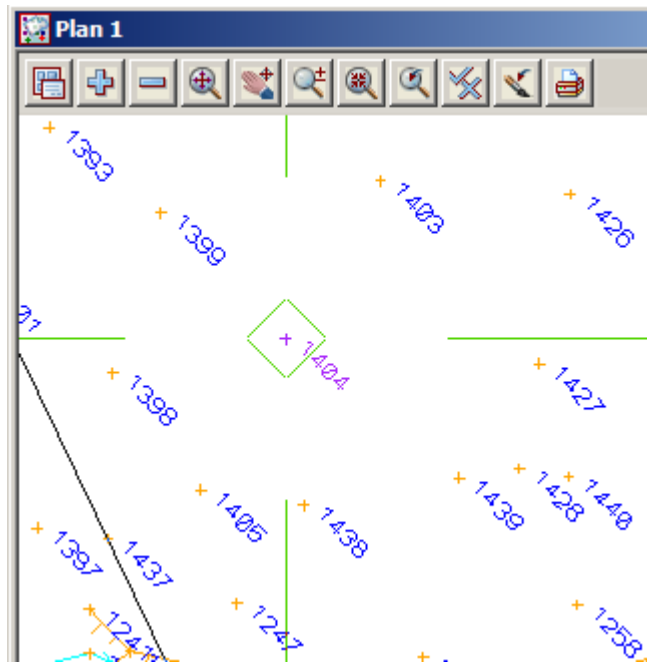
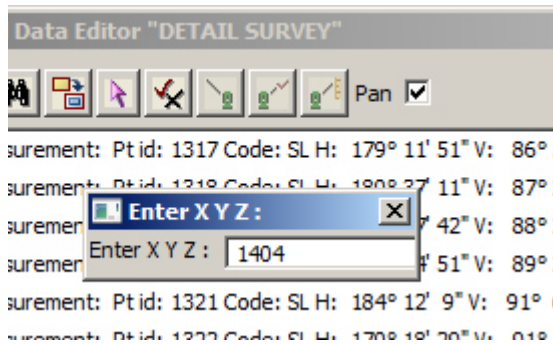

The point number will be highlighted.

If the point was not in the initial window then 12d pans to the point centring it in the view

If the point was in the initial view then the point is highlighted only

Once the point is confirmed the point is shown in the field file editor

NOTE. Always confirm the point selection as the string is "locked" until confirmation. An error will occur if the reduction is run with a locked string

The **Pan** check box can be ticked so that any point highlighted in the field file will be the centre of the plan view

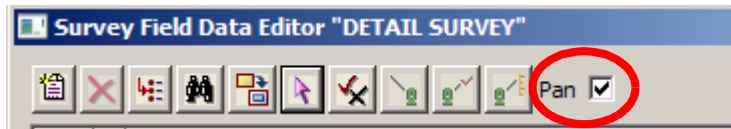

WARNING. Field file edits are different from manual cad edits and you must not edit the survey data with cad edits while performing field file edits. The reason for this is that after each field file edit the function is rerun and the edits are remembered by the function. Manual cad edits are not linked to the function and will be lost if the function is re-reduced. Duplicate data can also result in the incorrect use of cad edits while the field file reduction is running

Find and Replace

When reducing the field file the code **TBK** was listed as incorrect in the report file

We will use the **Find / Replace** option in the field file editor to fix the error

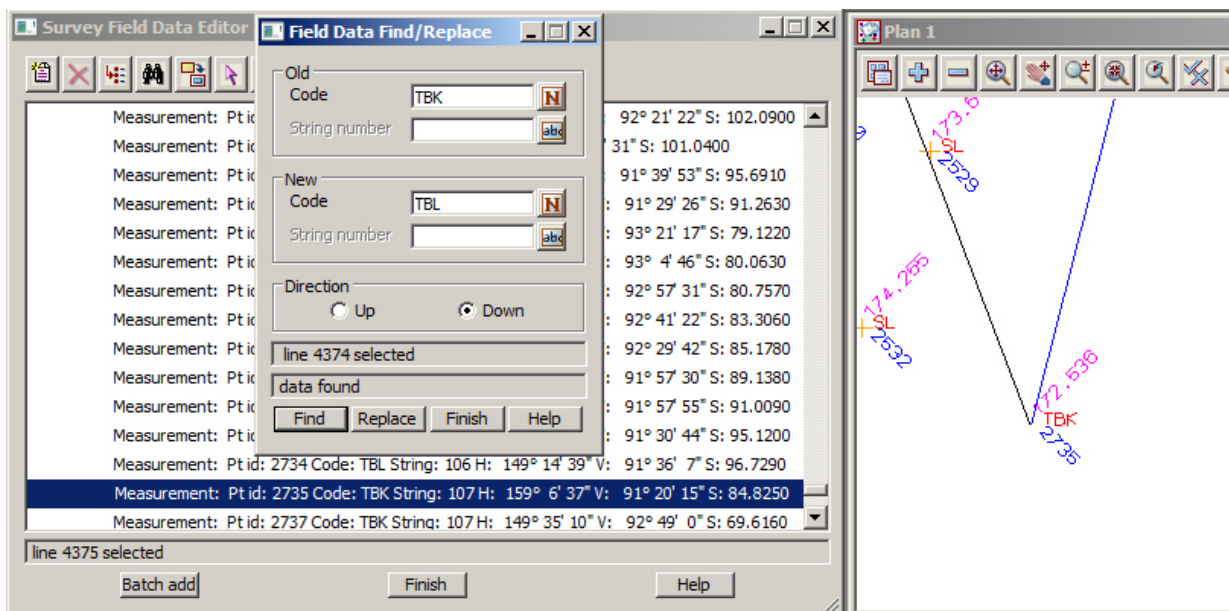
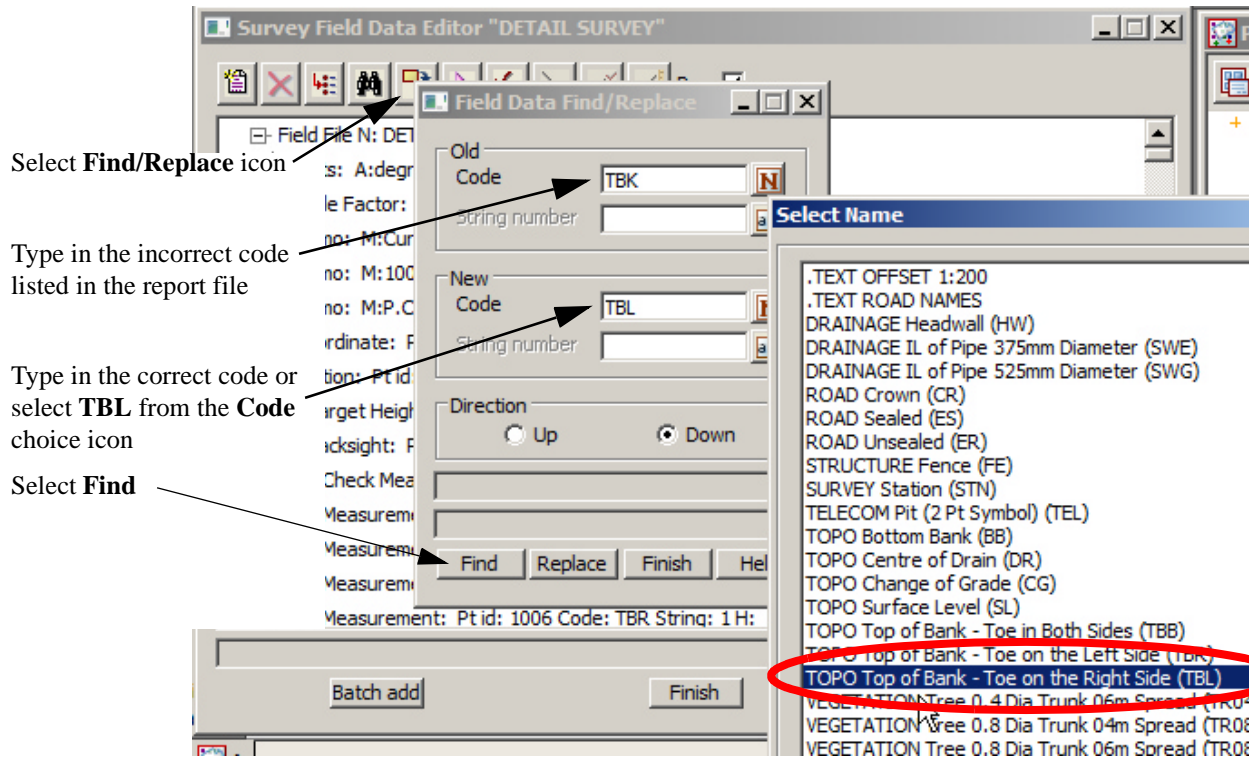

The first occurrence of the incorrect code is found and highlighted. If you have the **Pan** check box ticked the view will move to that point. To replace the code select **Replace**. Select **Replace** again until all corrections have been made.

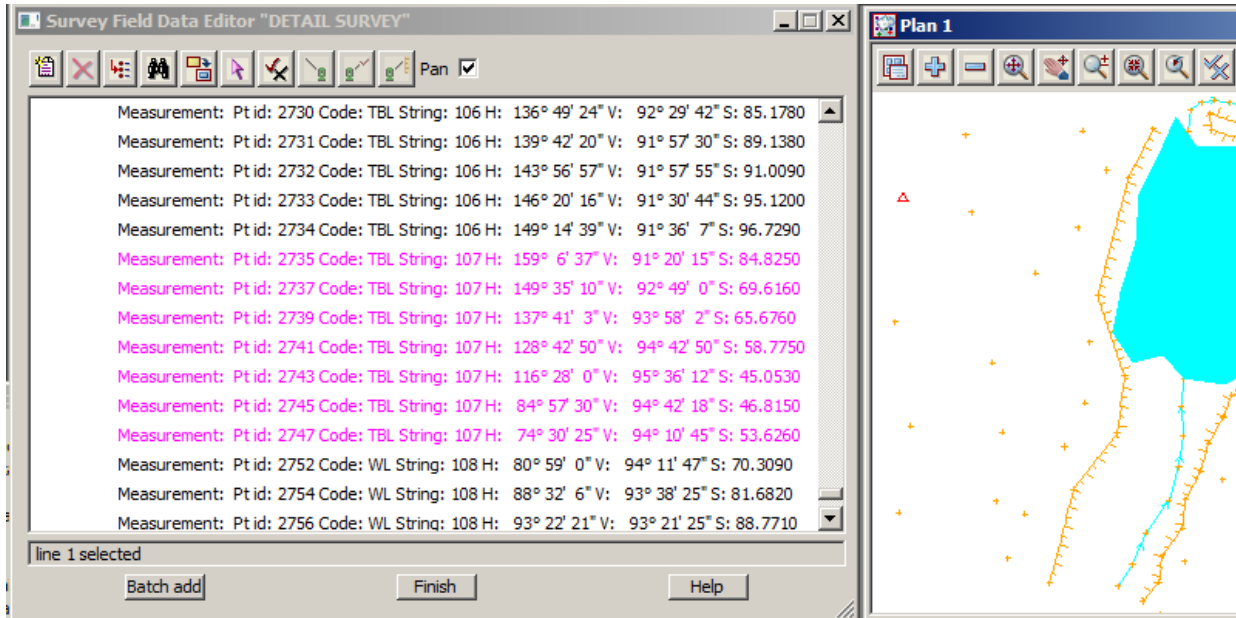

When the code is corrected the line in the field file is coloured magenta indicating that the reading has been changed.

We will look at the audit trail options in more detail later in this chapter

Changing codes

In addition to the Find/Replace option we can change a point's code by simply locating the measurement in the field file editor and editing the point. We will go through the individual point edits later. In the mean time we will use a menu option to change the code from pick list or by matching another point with the required code

Select the option *Survey=>Edit=>Coding=>Quick change* or select **Quick code edit** icon



Locate point 1267 by using the **Pick** icon in the field file editor

Select the correct code using the **Feature code** choice icon or by selecting **Sameas** button and selecting a point with the required code

Select **Pick** button then select the point to change

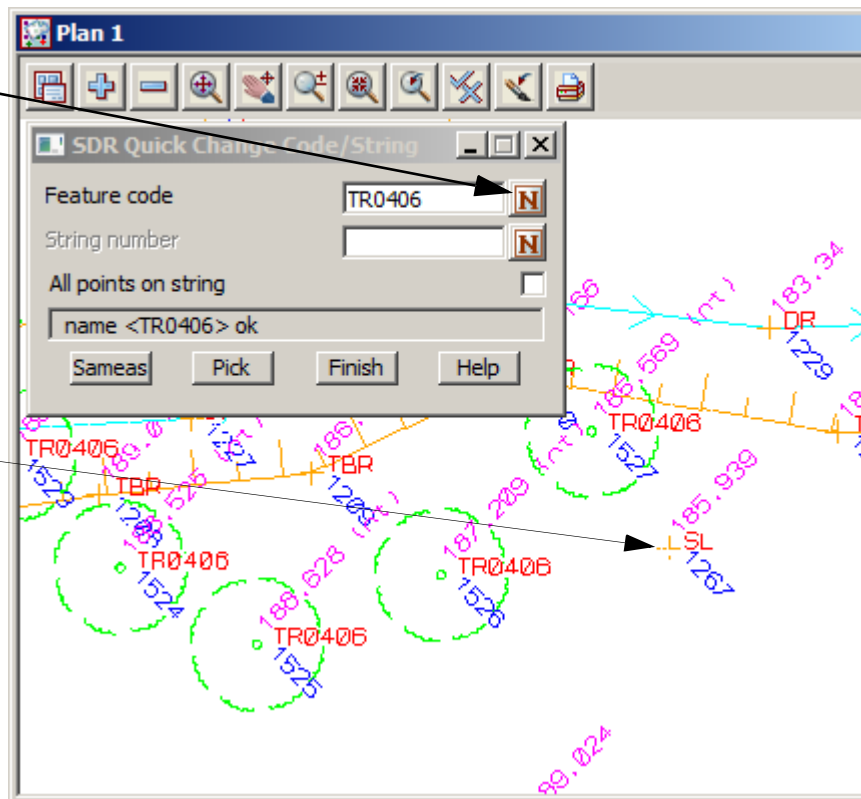

The function is rerun and the point now displays the properties of the new code.

The relevant line in the field file will also be highlighted magenta

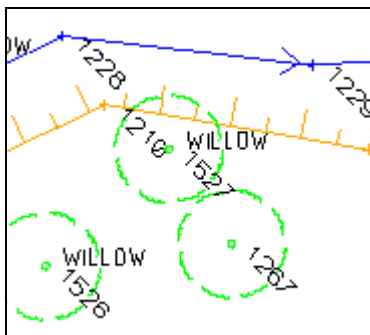

```

0° 36' 33" V: 96° 12' 42" S: 130.7030
7° 43' 23" V: 97° 4' 4" S: 121.7530
8° 14' 28" V: 98° 30' 34" S: 121.2530
+ 111° 34' 2" V: 99° 53' 43" S: 122.3590
4° 42' 45" V: 98° 0' 58" S: 110.0950
1° 3' 58" V: 96° 49' 41" S: 113.1630

```



Target heights

Another common error made during a detail survey is to incorrectly record the target height.

Instead of amending the level of the reduced point, a new target height can be entered into the field file reduction either manually or graphically

Select the option *Survey=>Edit=>Target height=>Insert* or select **Insert target height** icon



Locate point 1044 by using the **Pick** icon in the field file editor

Select **Pick** button then select the first point with the incorrect target

The target height is displayed at the bottom of the panel.

Type in the correct target height

If only one point has an incorrect target height then tick the **Just one point wrong** check box prior to selecting **Set**

Otherwise select **Set**

The function is rerun and the point now has the correct height. All subsequent points will also be updated until the next height of target line occurs

In the field file a new line appears stating the target height.

The line will be highlighted blue

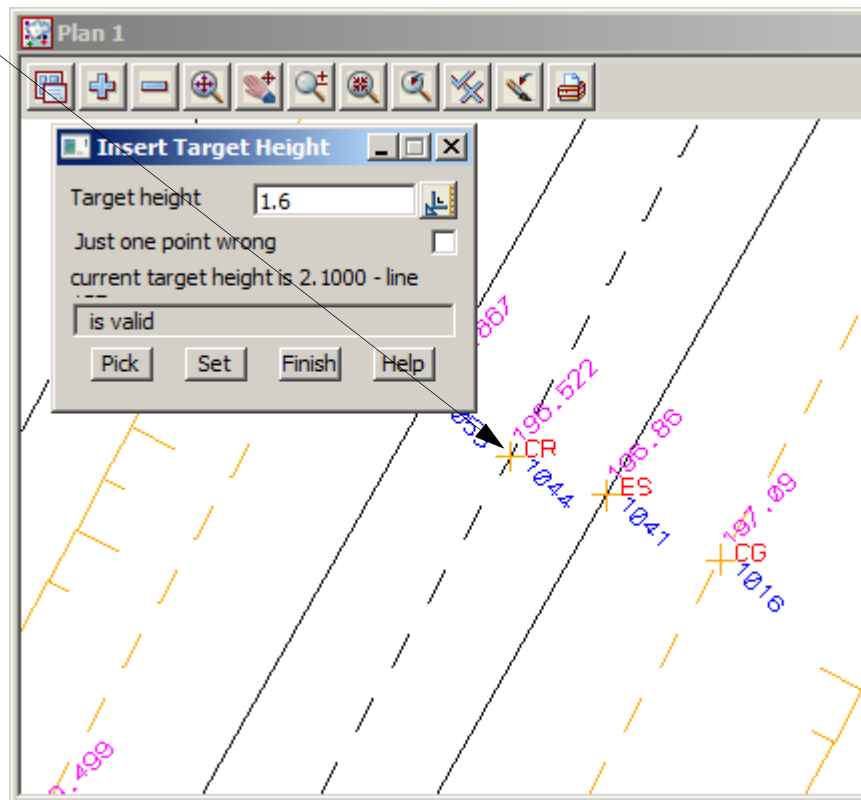

target height: 2.1000

Measurement: Pt id: 1043 Code: CR String: 7 H: 147° 2' 9" V: 91° 43' 34" S: 235.6150

Target Height: 1.6000

Measurement: Pt id: 1044 Code: CR String: 7 H: 142° 39' 41" V: 92° 30' 28" S: 227.3330

Measurement: Pt id: 1045 Code: CR String: 7 H: 137° 45' 13" V: 93° 18' 10" S: 220.2340

Reversing strings

If a string is surveyed in the wrong direction it can be reversed using the following option.

Select the option *Survey=>Edit=>Stringing=>Reverse*

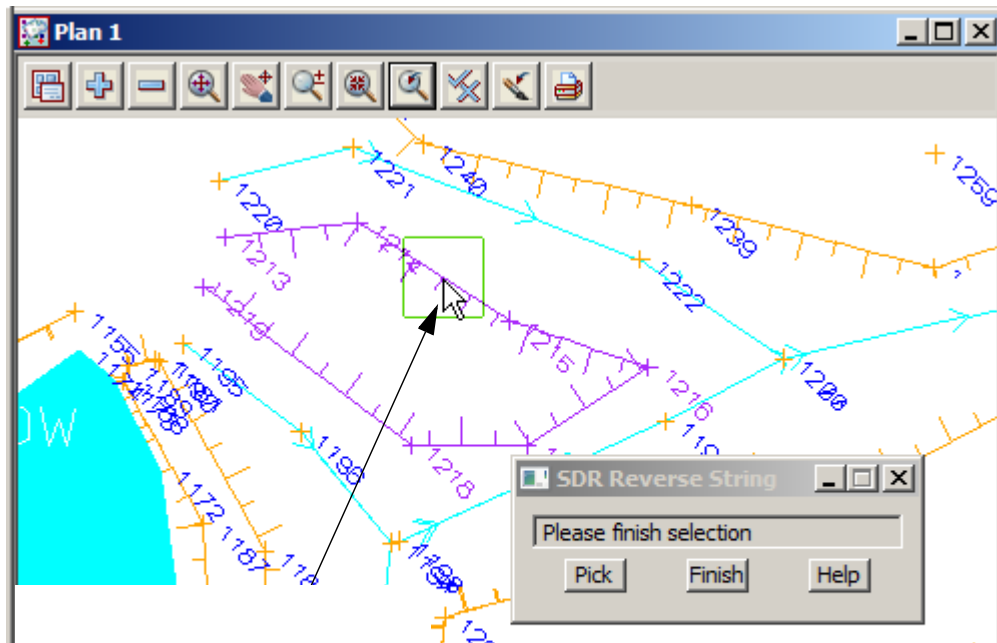

Pick the string to reverse

The function is rerun and the string is appended to the selected point.

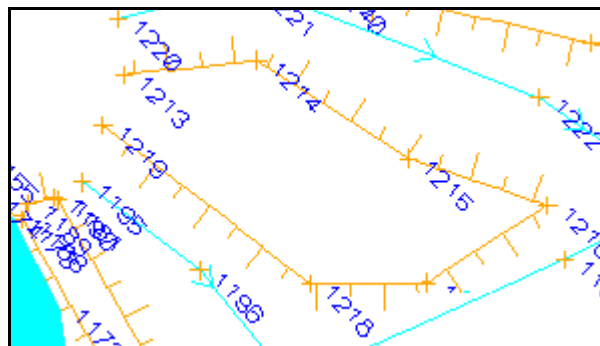

A Reverse string command will be inserted at the measurement line and this will be highlighted in blue

Measurement: Pt id: 1213 Code: TBL String: 30 H: 176° 8' 12" V: 95° 28' 48'
 Measurement: Pt id: 1214 Code: TBL String: 30 H: 165° 33' 21" V: 97° 0' 14'
 Reverse String:
 Measurement: Pt id: 1215 Code: TBL String: 30 H: 157° 28' 23" V: 100° 2' 5'
 Measurement: Pt id: 1216 Code: TBL String: 30 H: 150° 56' 53" V: 100° 50' 1'

Re-order string

If a string has been surveyed incorrectly the string can be re-ordered using a number of options including **Order by points**

Zoom in to point 2357

In the example here the point 2357 has been surveyed in the wrong order. Rather than stopping the string to take a single reading at point 2358 we simply string to point 2358 and then 2359 and so on.

To re-order the string by points use the option

Survey=>Edit=>Order=>by points

or **Order string** icon



Select point 2356. Then pick point 2358. At this point the string order is correct when reprocessed.

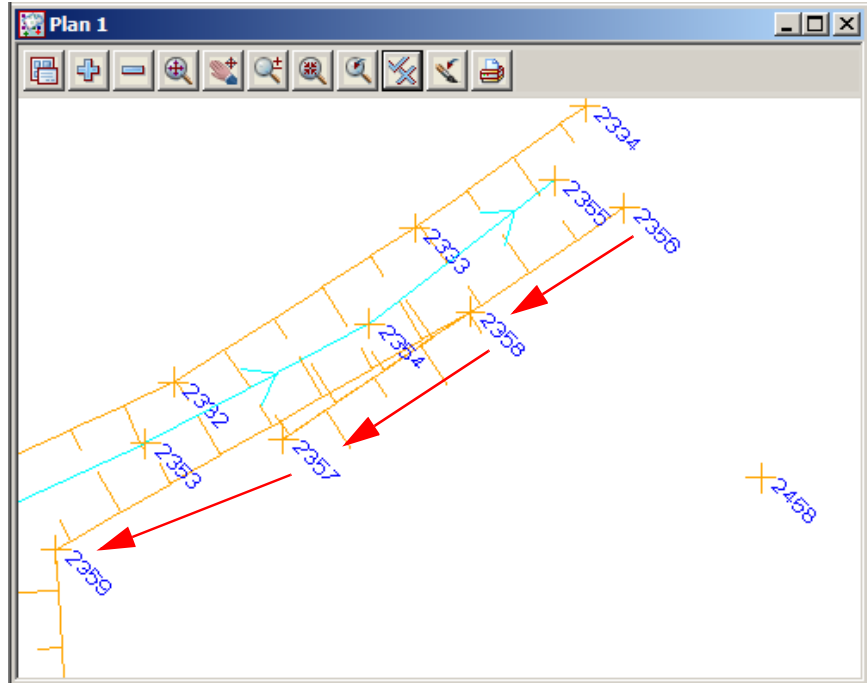

If the string order is done incorrectly the original order can be reinstated using the option

Survey=>Edit=>Order=>Remove

or **Remove order** icon



Pick on the string to restore the order and retry the ordering

9.6 Direct Editing of the Field File

Although the previous options were graphical, each change has been recorded in the field file reduction.

Data in the field file that has been changed in any way is coloured magenta.

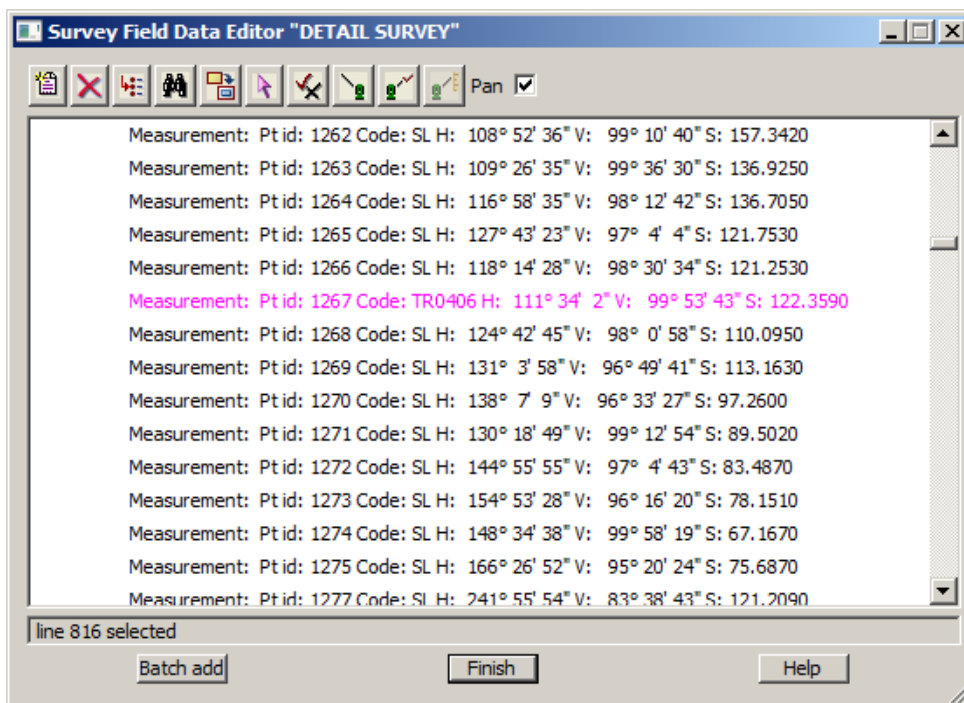

Data which has been entered directly into the field file or added via a command such as the *Target Height* option is coloured blue

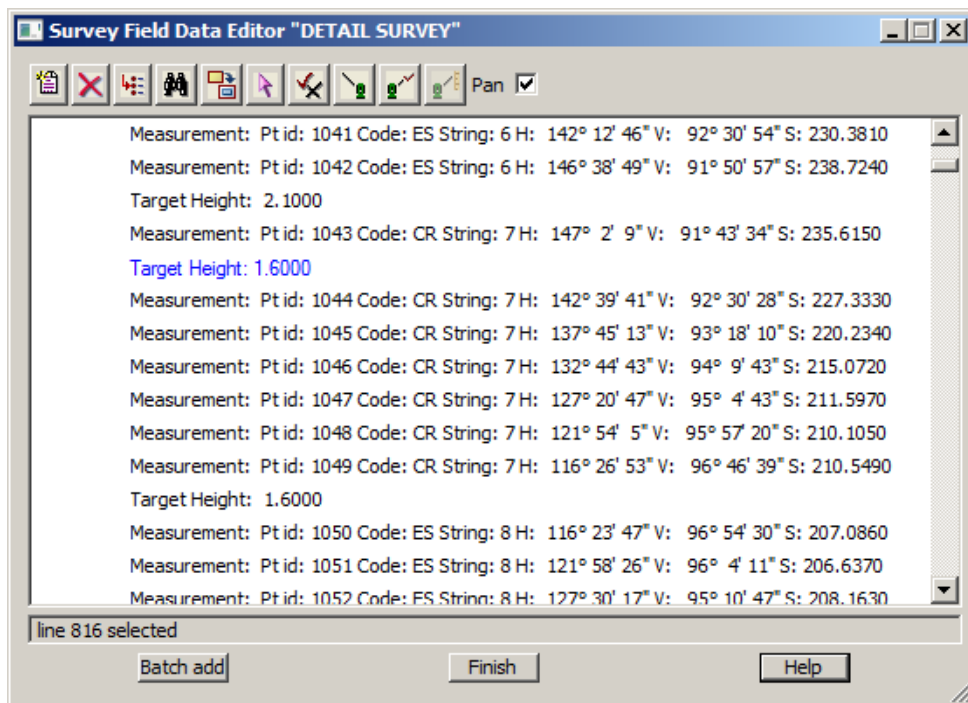

This colour coding gives an audit trail of any field file editing

9.6.1 To Find data in the Field File

The find option gives the user a number of methods to find data in the field file

Select the *Find* icon

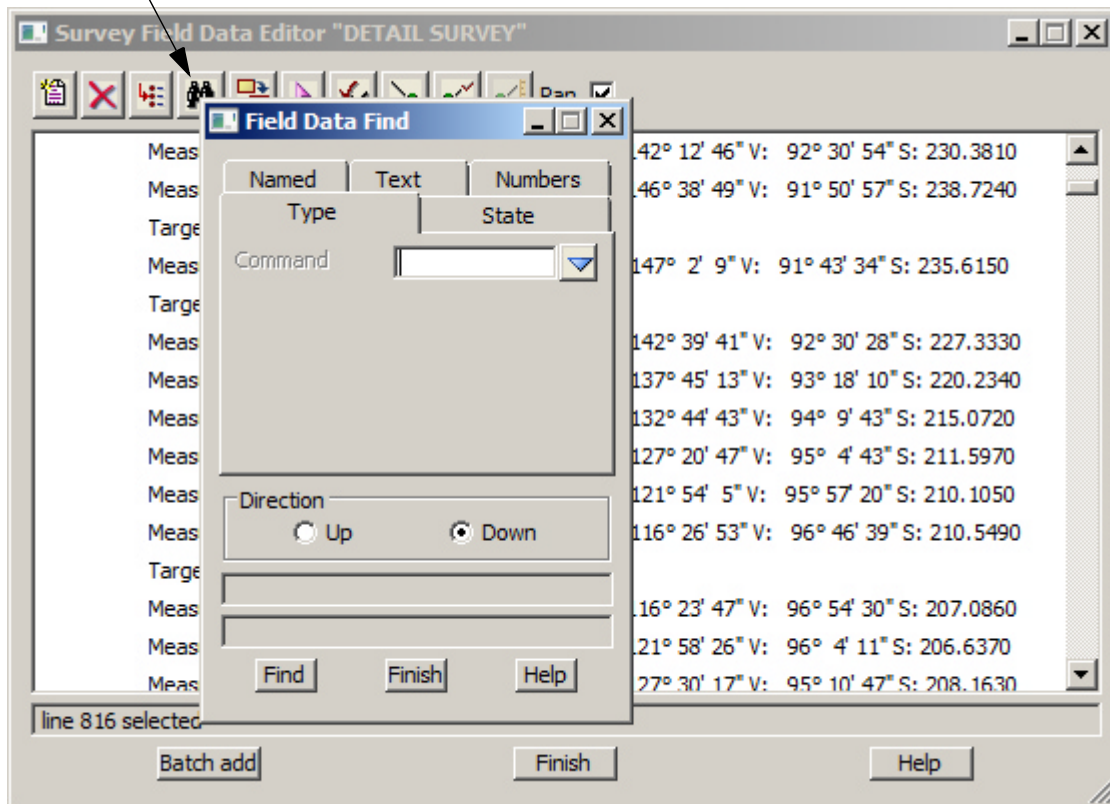

NOTE: You have to clear the current Find values before commencing a new search.

Named

A search can be performed on data in the field file using filters **Code, String number, Named point, Point number or attribute.**

To search for point number 2375

Select **Named** tab

Type in point number **2735**

Select **Find**

The line is highlighted

This example is generally not used as the user can locate a point by simply clicking on the **Find by Pick** icon at the top of the panel and typing in the point number

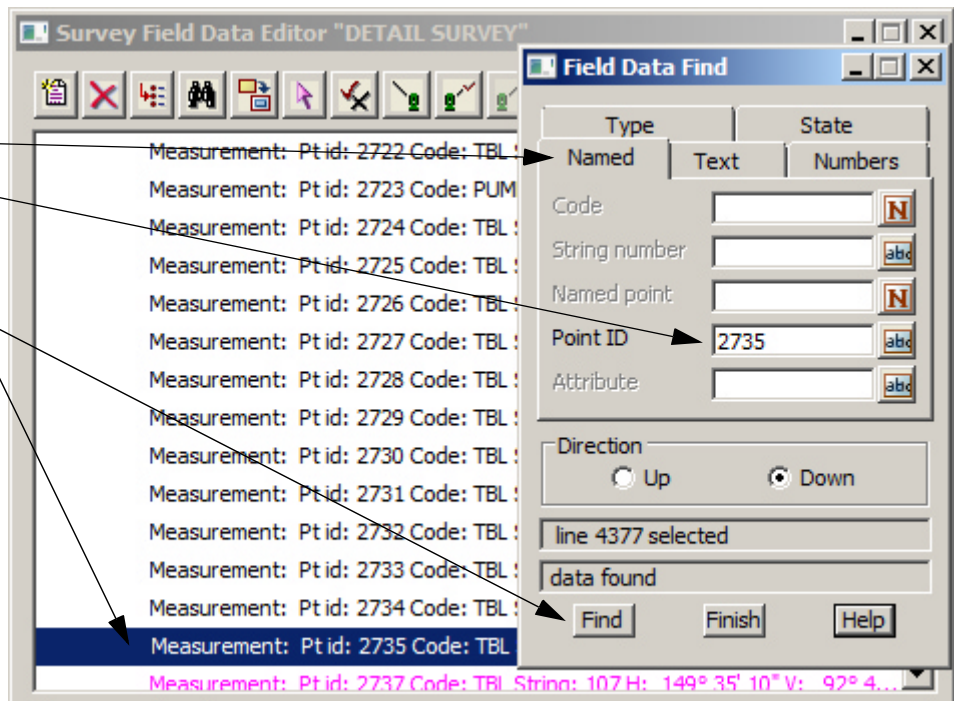

Type

A search can be performed on data in the field file given a particular command type.

To search for an *Arc Fitting Start* command

Select **Type** icon

Select Command choice **Arc fitting start**

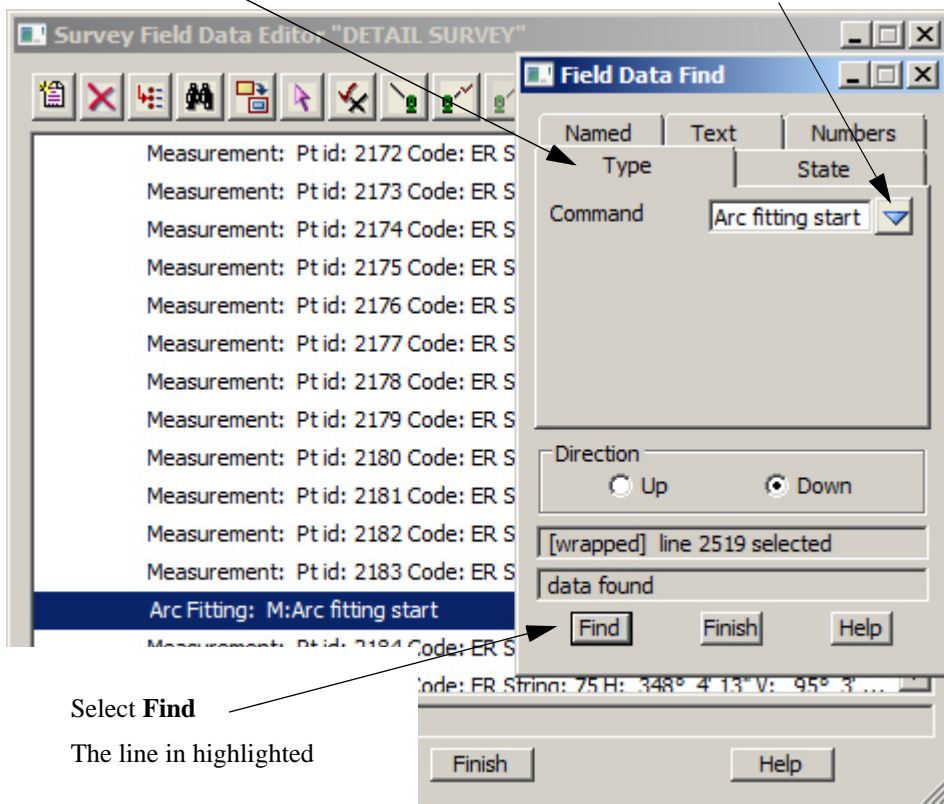

Select **Find**

The line is highlighted

State

A search can be performed on data in the field file given a change of state including **added**, **changed**, **deleted** or **field**. To search for a **changed** state

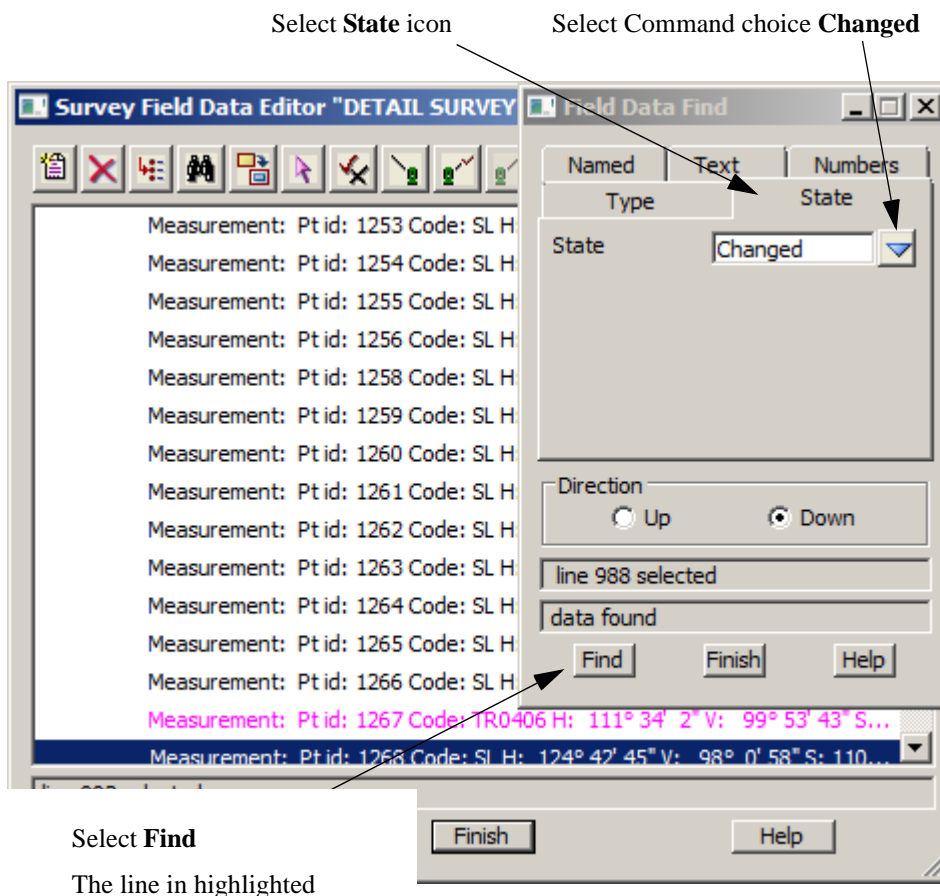

To Edit a Field File Line

Double click on the line in the Field File to edit.

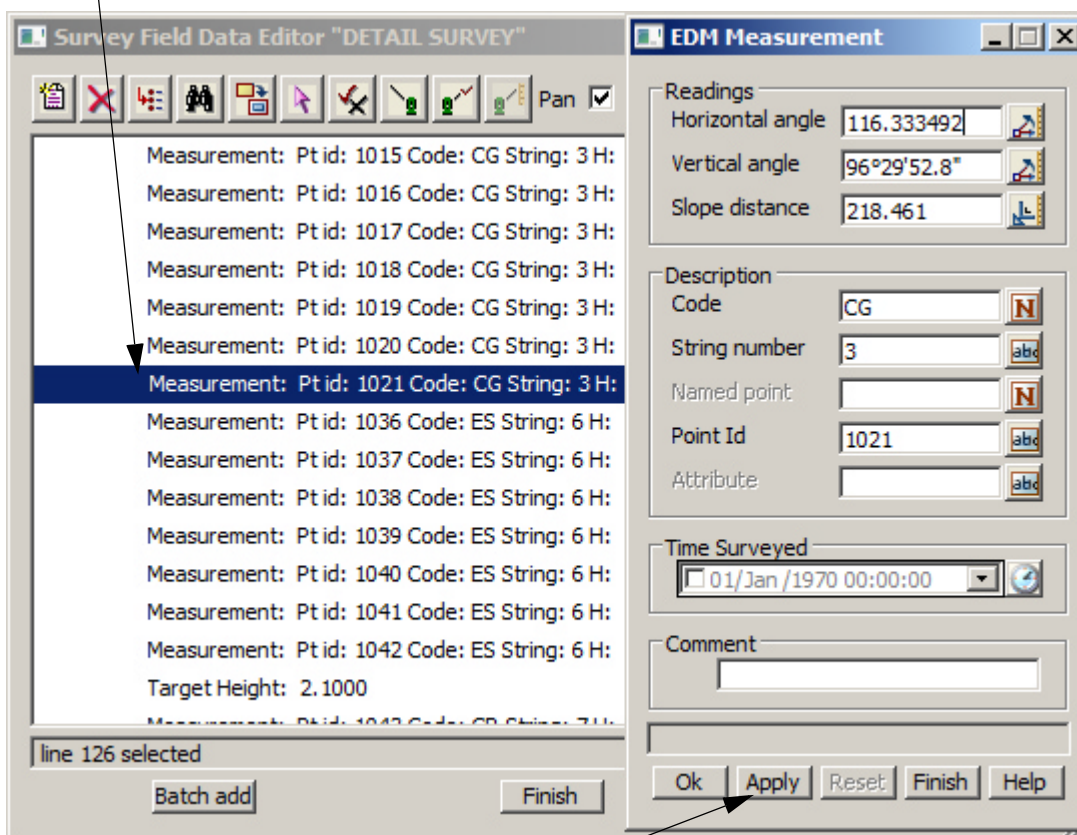

A panel appears with editable fields

Any data can be changed

To set the changes press **Apply**. The field file reduction will rerun updating the graphics and the field file line will appear in a magenta colour.

Select **Finish** to save the change or select **Reset** to cancel the change and then **Finish**.

To Insert a command

A command can be placed in the field file. Often any graphical field file edit can be substituted with an Insert command.

To insert a **Vertical circle correction** put the cursor on line where entry is to be made

Press **Insert** icon

Select the Command choice and select the Command

Vertical circle correction. Select Create

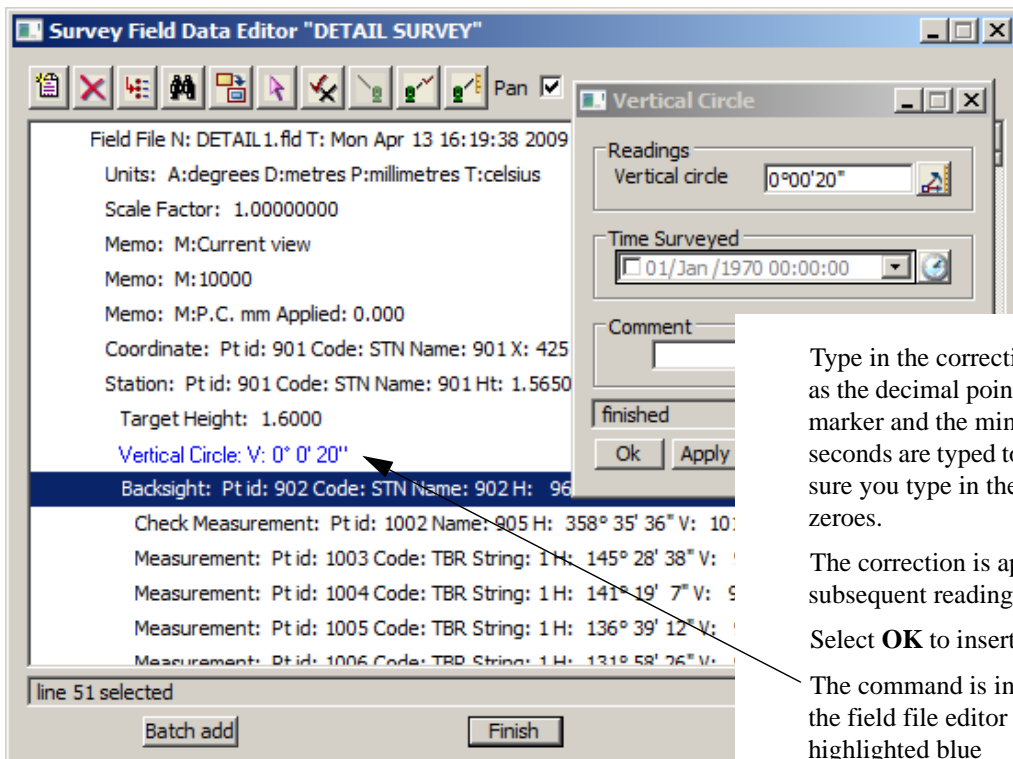
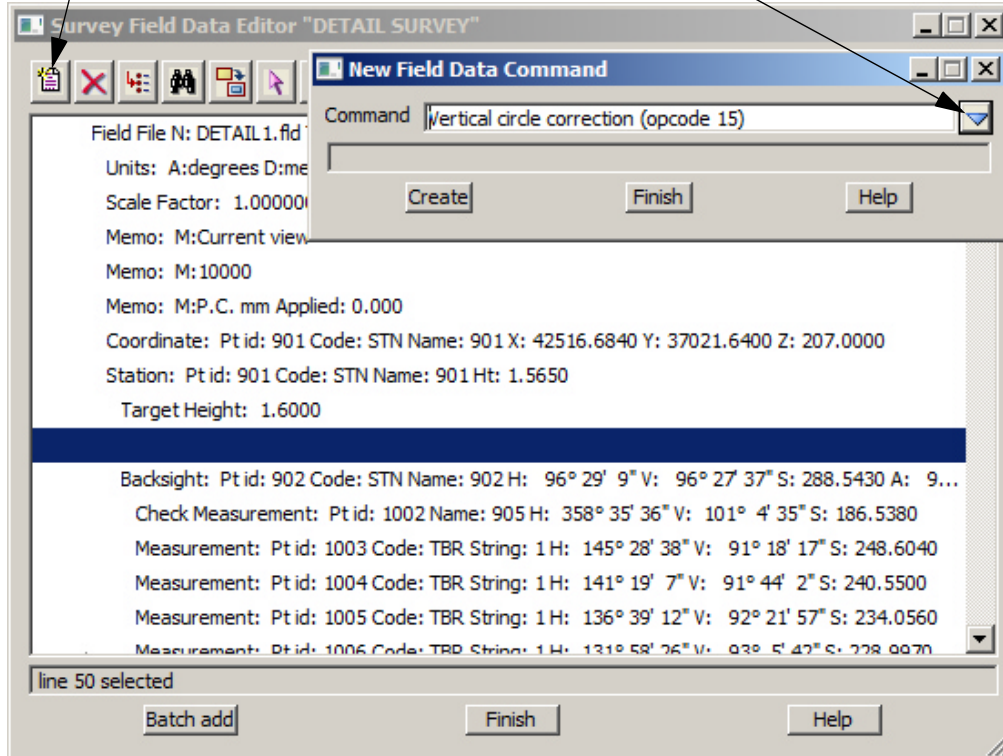

Type in the correction as **0.0020** as the decimal point is the degree marker and the minutes and seconds are typed together. Make sure you type in the trailing zeroes.

The correction is applied to all subsequent readings

Select **OK** to insert the command

The command is inserted in to the field file editor and is highlighted blue

Deleting a Line

To delete a line in the field file put the cursor on the line to be deleted

Select the **Delete** icon

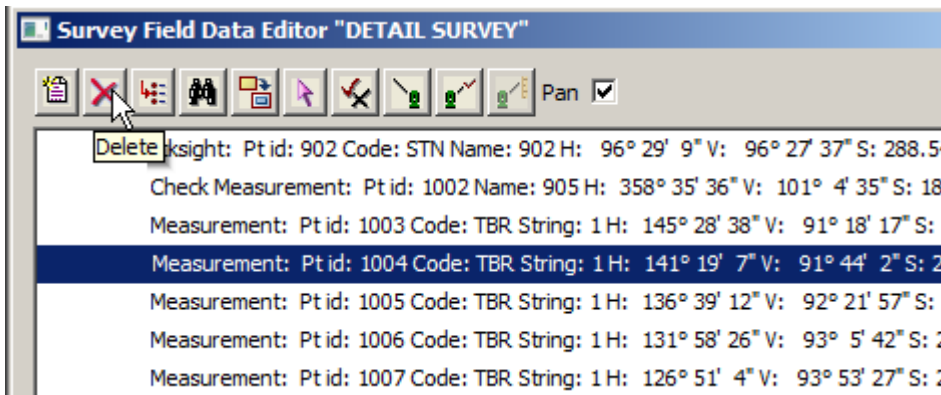

When a line of data is deleted a red cross is placed at the start of the line.

When the function is rerun, Backsight and Check measurement prompts will redisplay. Select **Yes to all** and **Continue all** to accept the default settings on the panels.

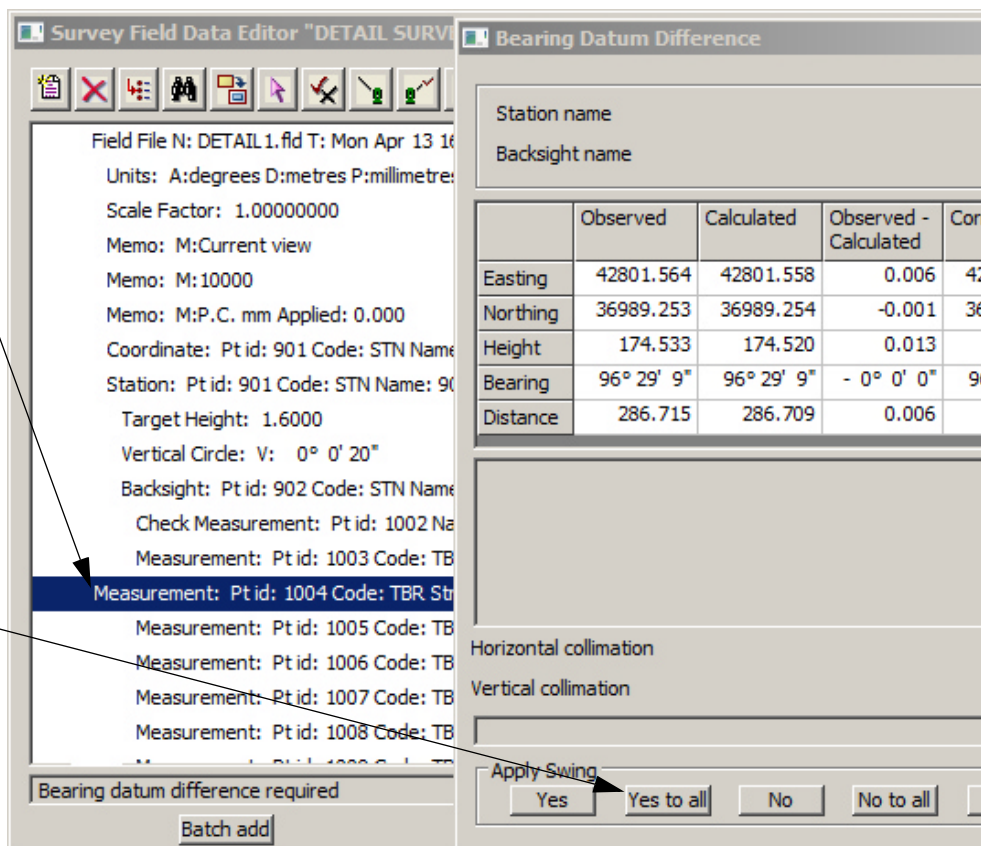

To **undelete** a line simply highlight the deleted line and select **Delete** again

We can now finish editing the field file. Click on **[Finish]** to exit the editor

9.7 Printing the Report File

When the field file edits are complete print the Report file

Select **Report => Edit**
or **Edit a file *.rpt** icon



and select the relevant file

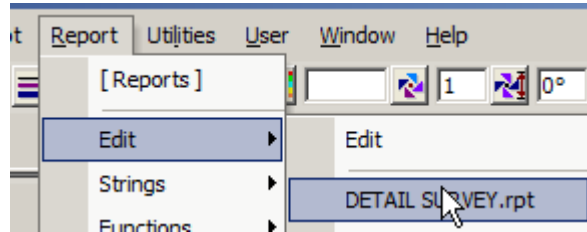

```

DETAIL SURVEY.rpt - Notepad
File Edit Format View Help
Survey Data Reduction
=====
Reduction report for field files
DETAIL1.fld

New scale factor 1.00000000
Memo: Current view
Memo: 10000
Memo: P.C. mm Applied: 0.000
Coordinate for station "901" defined from control model "SURV STATION->STN"

Occupying Station      : 901
Coordinates            : E 42516.684  N 37021.640  H 207.000
Code                  : STN
Instrument Ht          : 1.565

New vertical circle correction 0.00555556
Coordinate for Backsight "902" defined from control model "SURV STATION->STN"
      96° 29' 9" 96° 27' 37" 288.543  1.600  42801.564  36989.254  174.533

***** Backsight to "902" Code "STN" *****

      OBSERVED      CALCULATED      OBSERVED -      CORRECTED      CORF
      (SWUNG)                CALCULATED
EASTING      42801.564      42801.558      0.006      42801.564
NORTHING     36989.253      36989.254      -0.001     36989.253
HEIGHT       174.533      174.520      0.013      174.533
BEARING      96° 29' 9"      96° 29' 9"      0°
DISTANCE     286.715      286.709      0.006      286.715

Bearing datum difference  0° 0' 0" applied to subsequent measurements

Coordinate for Check measurement "905" defined from control model "SURV STATION->STN"
***** Check Measurement to "905" Code "" *****

      OBSERVED      CALCULATED      OBSERVED -
    
```

The report file is displayed in your default text editor and can be printed to keep a record of the survey reductions

9.7.1 Locking the Data Reduction Function

After all field file edits have been made it is important to ensure that the data reduction function can not be rerun.

This is because if any non-field file operations are performed on the reduced data and then the reduction is rerun, the non-field file operations may be lost

Once the function has been locked it can't be rerun by mistake resulting in data integrity problems

To lock the Data reduction function
 Select **Utilities=>Functions=>Lock**
 or **Function lock status** icon

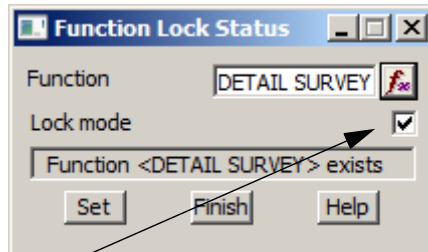

Select the **Function** choice icon and select the function name **DETAIL SURVEY**

Tick the **Lock mode** check box

Select **Set** and **Finish**

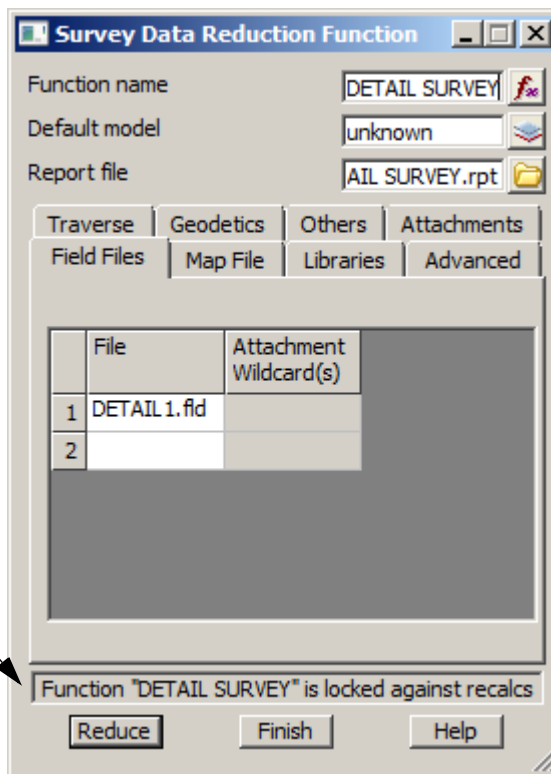

If the function is rerun, the following error message occurs

9.8 Graphical Edits

We now edit the survey graphically to perform tasks either not available in the field file editor or in some case easier to do graphically.

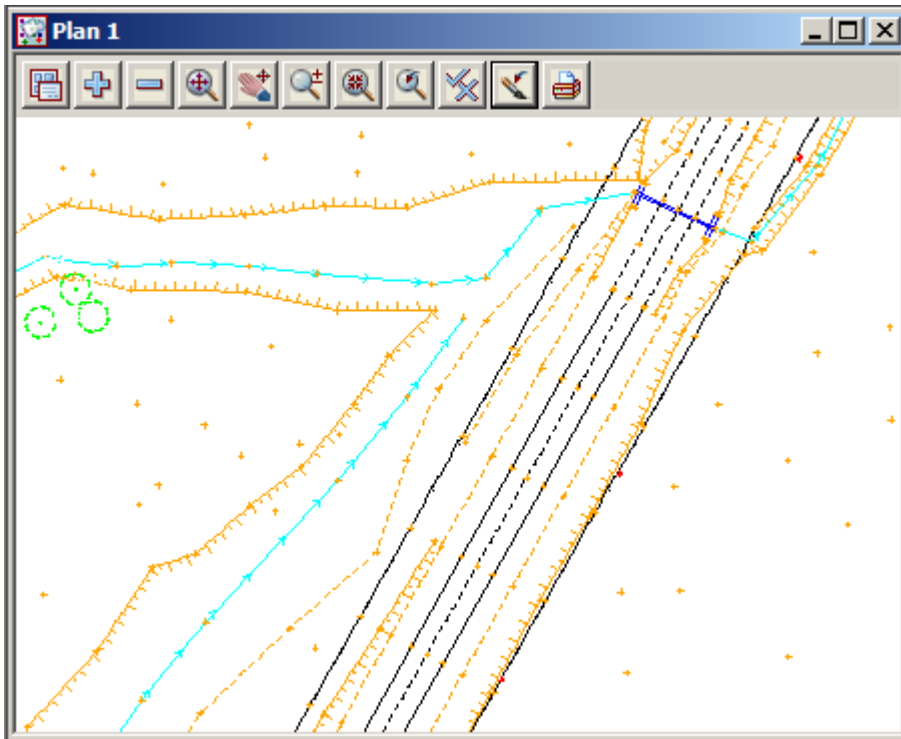

Most of the options used in the following examples are duplicated under the *Strings=>Cad* menu

9.8.1 Joining strings

Join

Select *Strings=>Strings Edit=>Join*

or cad option **String Join**

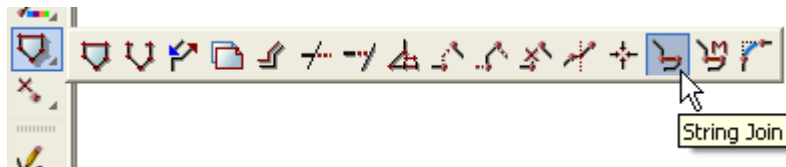

Points can be joined in a number of ways. The first type of join will result in two strings of the same type being combined into one string. If the two strings are different, then the resulting string uses the properties of the first string selected

Zoom in to point number 1232

This string will be joined to the string starting at point 2112

Hold down the left button and drag a short distance along the left string with direction **towards** point number 1232. Release the left button then select middle button to accept

Select the right string in the same way with direction **away** from point 2112 and accept

The strings are joined to make one string. In this case the string will require reversing which is explained later

Repeat for all of the other gaps in the survey where the two strings have the same properties and you are joining the ends (not joining from an end to a corner of a string)

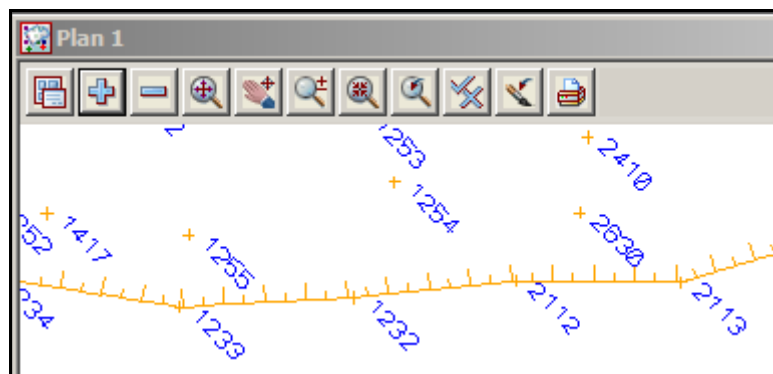
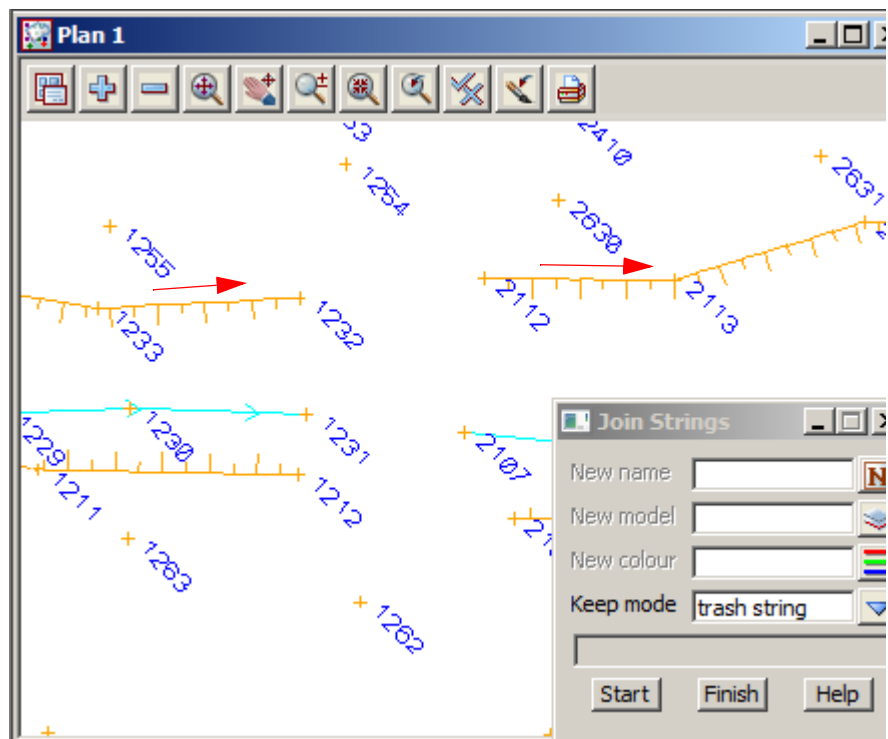

Append

Select *Strings=>Points Edit=>Append*
or cad option **Append Point**

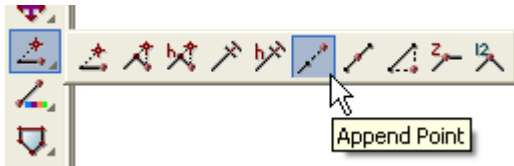

This option is used to append the end of a string on to another point on a string

Zoom in to point number 1100

Select point 1116 and accept

Select point 1100 and accept

Press [Escape] to finish picking

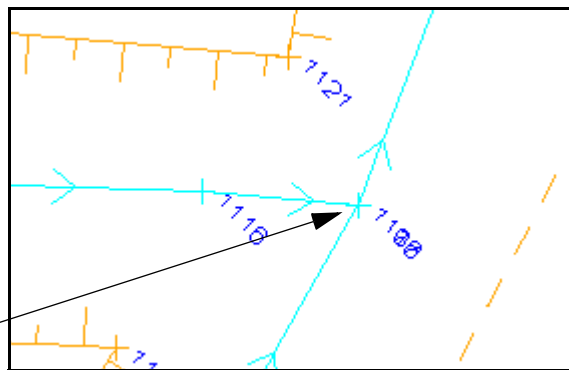
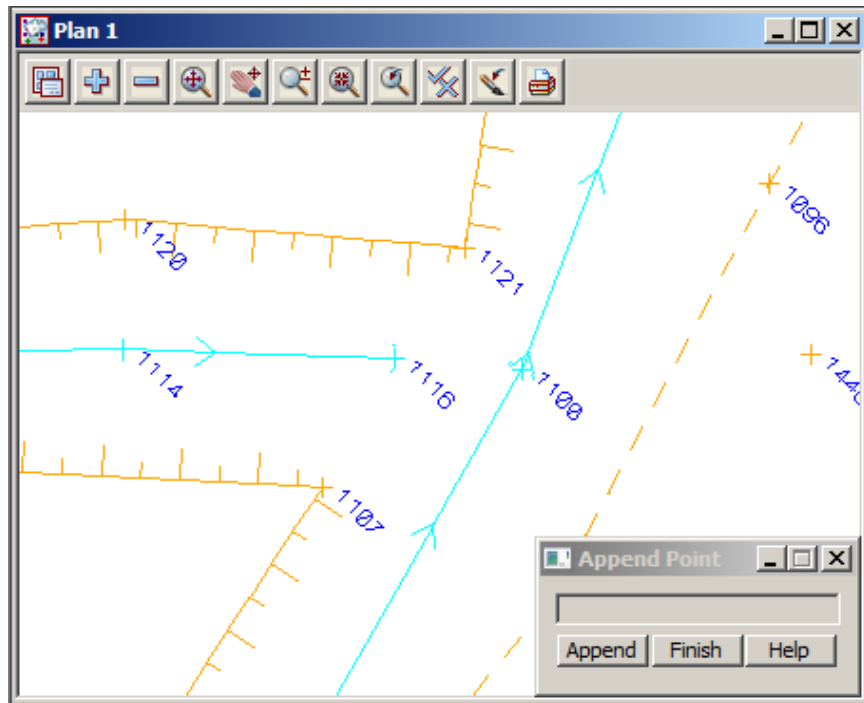

The first strings is appended to point 1100

If the point id's are turned on the appended string will duplicate the last point id.

If you use the cad option no point id will appear on the appended point

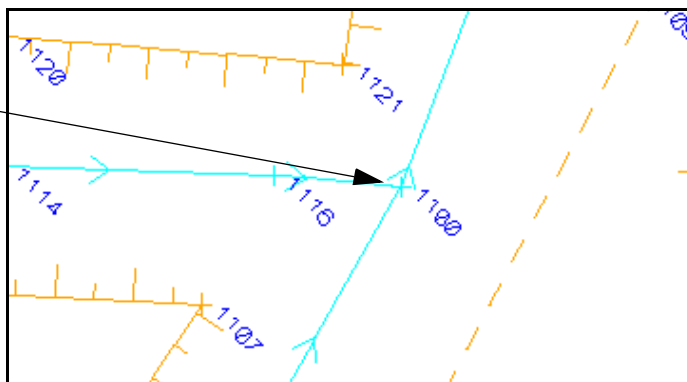

Cad Create Line

A line string taking its default properties from the **Cad Controlbar** can be created. This will create a single line string independent of the two points selected.

Firstly select the properties for the new string by manually changing options in the **Cad Controlbar**



When editing a survey you should be using the **Name** icon to select the relevant code. Once the code is selected (in this case **TBL**) the rest of the cad control bar is filled in. The file names.4d is used to set up this process. It is very similar to a mapping file used to read in the survey initially

The other method of presetting the cad control bar is to use the **Sameas** icon to pick a point on the string with the properties required.

Zoom in to point 1185

Select option *Strings=>Cad=>Lines=>Line* or select **Create line** icon

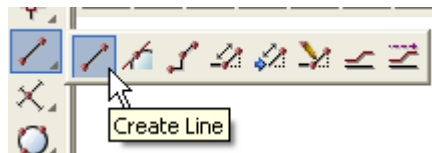

Select point 1185 and accept

Select point 1163 and accept

A new string is created between the two points

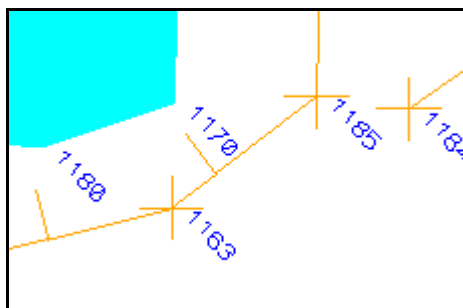
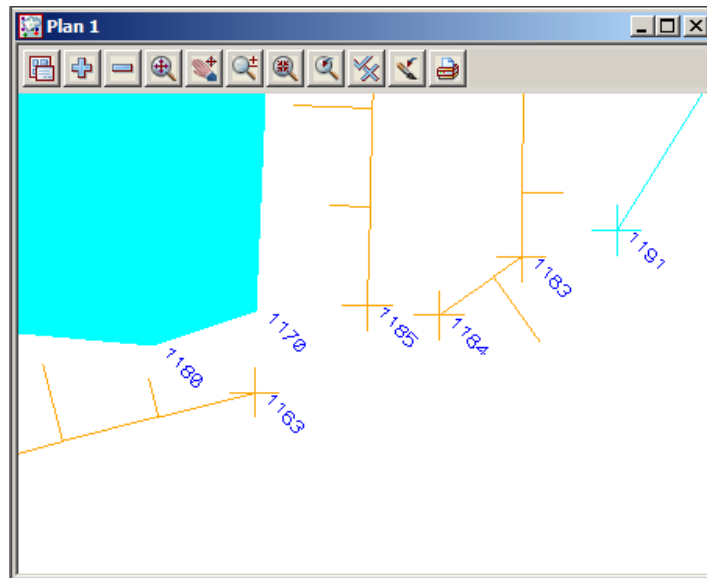

Close

If a gap appears between the end and the start point of a string then we join these points together (or close the string) to form a polygon. This option is also available in the field file editor. It should be noted that as many field file edits as possible should be used instead of manual edits as there is no audit trail in manual edits

Zoom in to point 1213

To close the string select option
Strings=>Strings Edit=>Close
 or the **String Close** icon

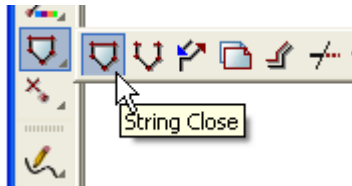

Select any where along the string and accept.

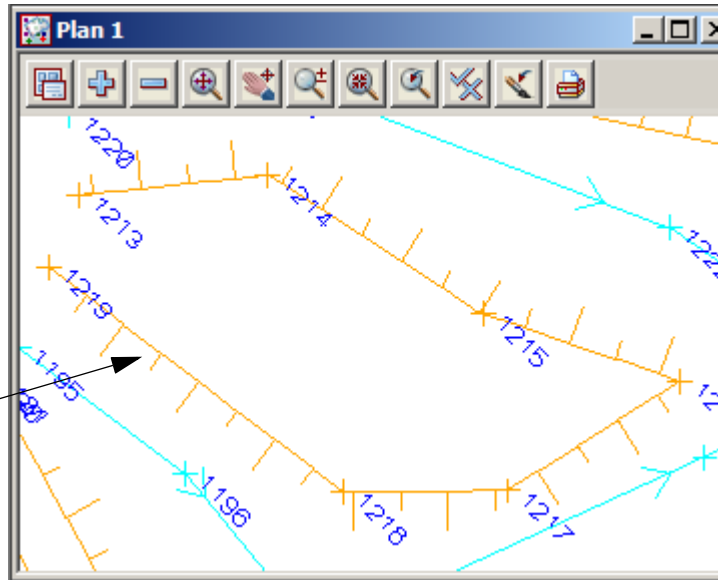

When inquiring on a closed string, the area is displayed in the information panel

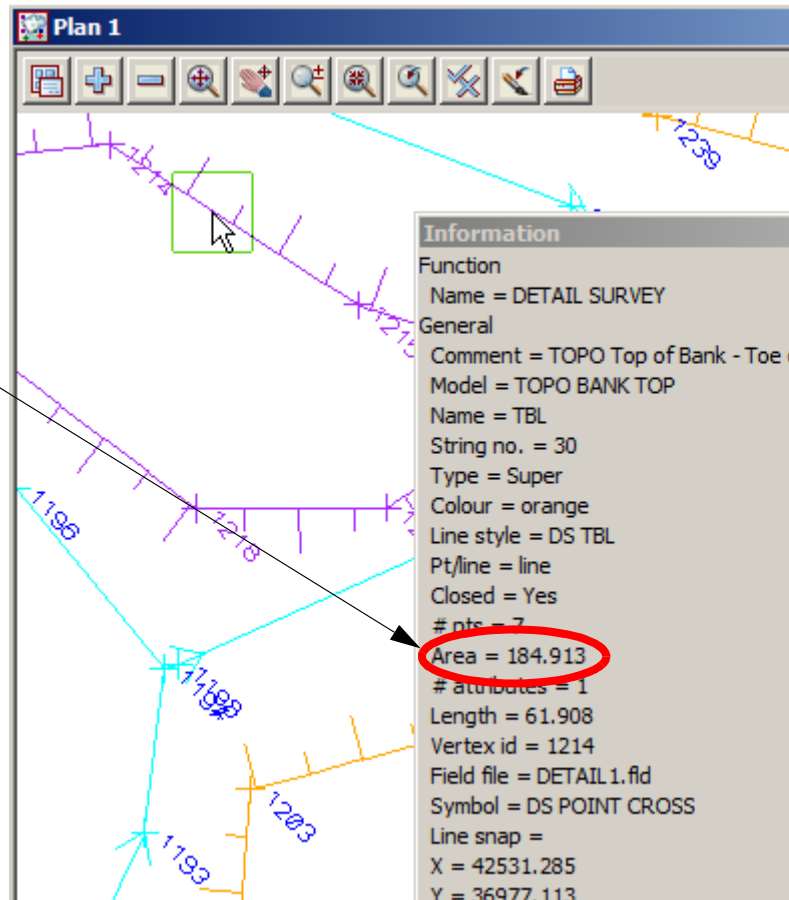

9.8.2 Reverse String

If strings are created with the linestyle shown on the wrong side then the string can be reversed.

Zoom in to point 1238

Select option *Strings=>String Edit=>Reverse*
or **String reverse** icon

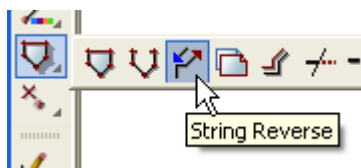

Select the string and accept

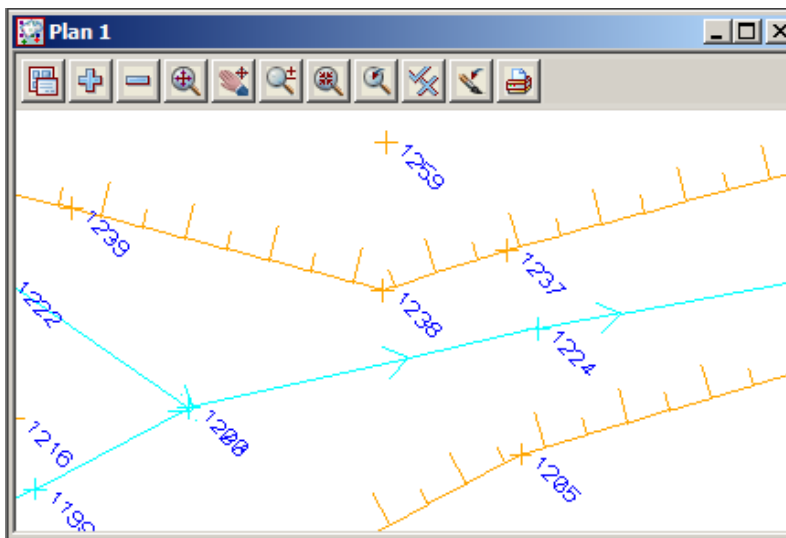

The string direction is reversed

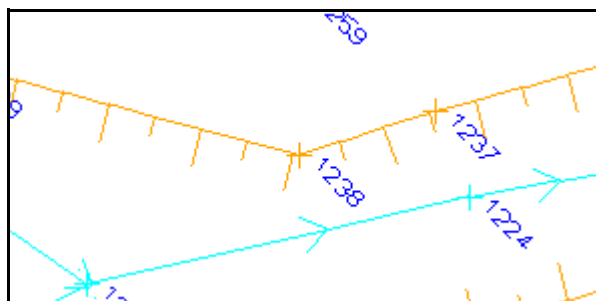

9.8.3 Add arc to curve

An arc can be placed in to a string by selecting the middle point of the curve.

Zoom in to point number 2286

Select option *Strings=>Points*
Edit=>Add 3 Pt curve

or **Insert 3pt Curve** icon

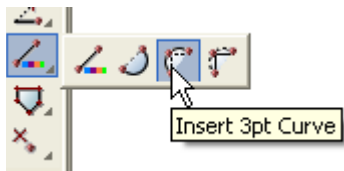

Select point 2286 and accept

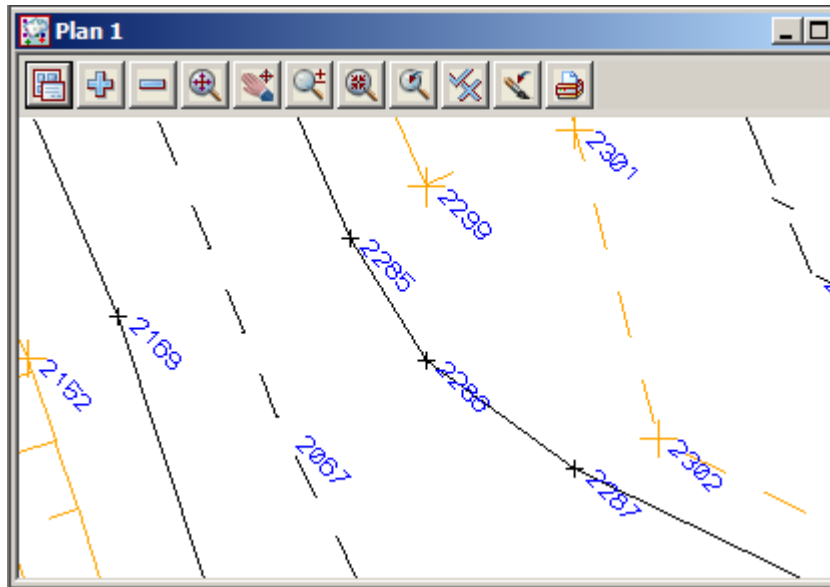

A curve is created

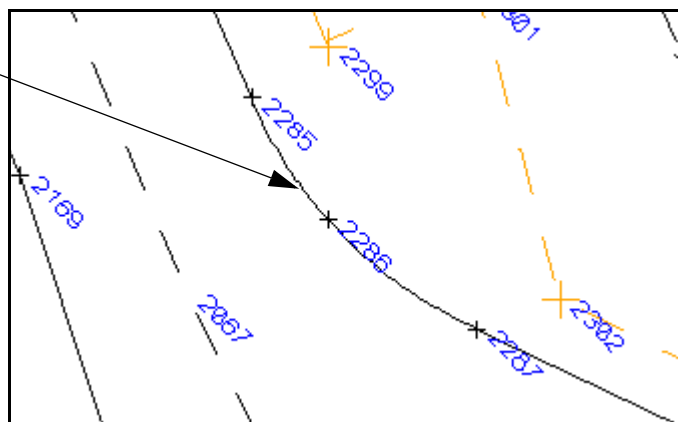

9.9 Triangulation

The survey is ready to form a triangulation from the tinable data that is displayed in the view.

Ensure that all models are turned on in view 1.

9.9.1 Check for Crossing Breaklines

Prior to forming the triangulation we need to check for any overlapping breaklines.

If not corrected these will cause errors in the triangulation.

Coloured diamond shapes can be created around the errors along with a report file

Select option *Tins=>Check Breaklines*

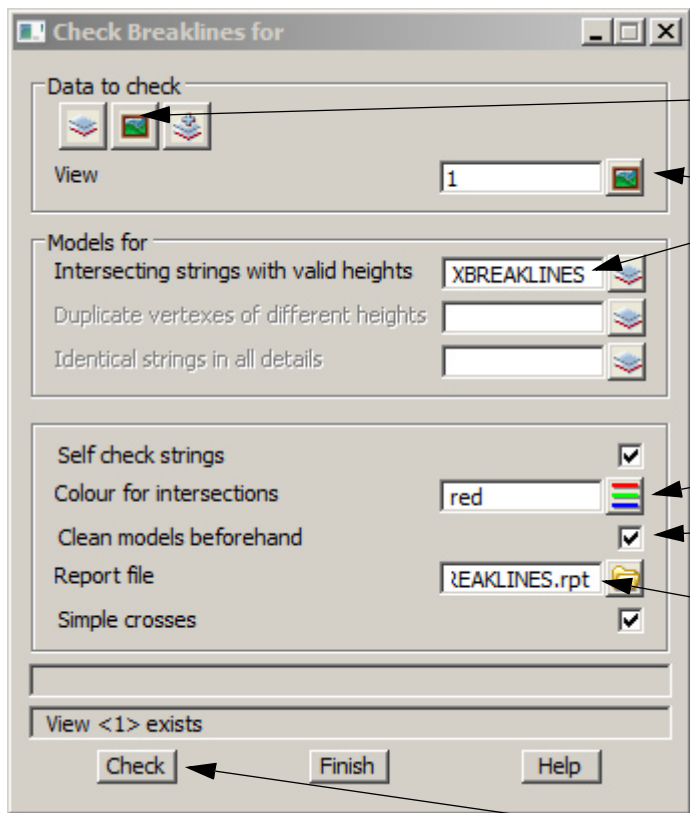

The screenshot shows the 'Check Breaklines for' dialog box with the following settings and annotations:

- Data to check:** The 'View' dropdown is set to '1'. An arrow points to the 'View' icon, stating: "We want to check all data in View 1 so select **View** icon".
- Models for:** The 'Intersecting strings with valid heights' checkbox is checked and labeled 'XBREAKLINES'. An arrow points to this text, stating: "Type in model name **XBREAKLINES** to create strings around the errors".
- Self check strings:** The 'Colour for intersections' dropdown is set to 'red'. An arrow points to this, stating: "Select the colour **red** for the strings".
- Clean models beforehand:** The checkbox is checked. An arrow points to it, stating: "Tick check box to **Clean models beforehand**".
- Report file:** The text field contains 'XBREAKLINES.rpt'. An arrow points to it, stating: "The report file name **XBREAKLINES** is typed in. Press [Enter] after entering the text and the extension **.rpt** is added".
- Simple crosses:** The checkbox is checked.
- Buttons:** The 'Check' button is highlighted with an arrow, stating: "Select **Check**".

NOTE - report files are not available in the 12d Model Practise Version

```

XBREAKLINES.rpt - Notepad
File Edit Format View Help
Project:    DETAIL SURVEY
User:      Noel
Organization: 12d Training - Qld
Report File: XBREAKLINES.rpt

Intersection at      42768.0301      37107.1615 levels      164.902      164.787 - "ROA
  
```

The report is generated and displayed in the default text editor.

At the bottom of the report the intersections are listed giving the model names, co-ordinates and codes of the intersection strings

Print out the file and exit the text editor

Drag the **Check breakline** panel over to the edge of the screen as we will rerun the option at a later stage

Turn on the model **XBREAKLINES**

Zoom in to the red diamond at point 2275

A red diamond appears centred at the intersection of the two strings

To correct we will insert point 2275 into segment from point 2065 to point 2066

Select option **Strings=>Points edit=>Insert** or **Insert point** icon

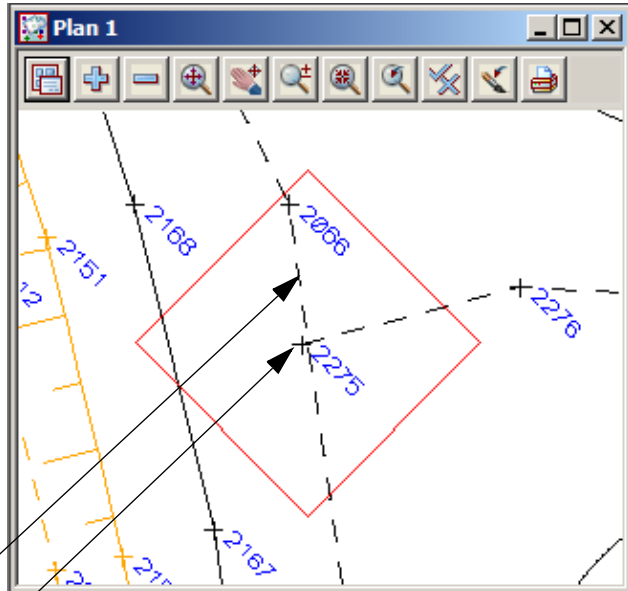
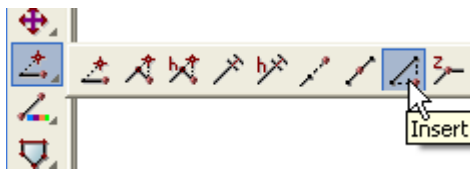

Pick and accept the string between point 2065 and 2066

Pick and accept point 2275

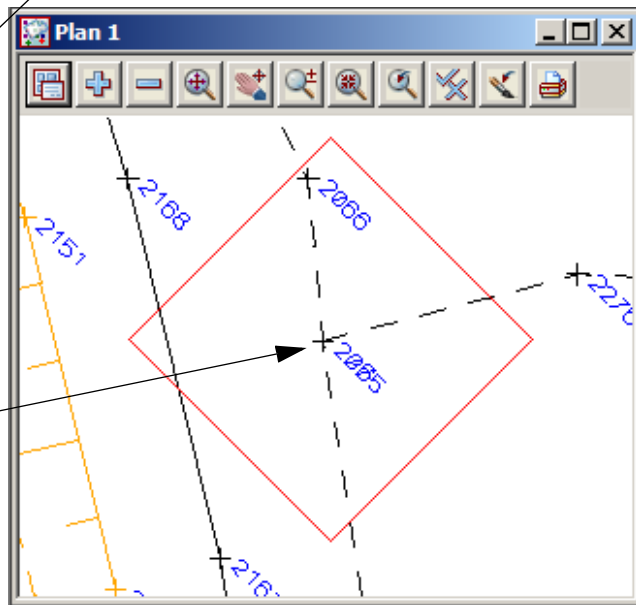

The string now has a vertex at point 2275

Lastly delete the diamond string surrounding the crossing breakline. We delete the diamond string as it has levels at the vertices and if the **Check Breakline** option is rerun without the **Clean models** option ticked, more crossing breaklines would result

Select **Strings=>Delete** or **String delete** icon

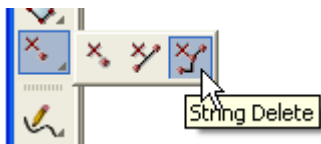

Pick the diamond and accept

As the **Crossing Breakline** panel is still active rerun the option to confirm all crossing breakline have been fixed

9.9.2 Delete empty models

Prior to creating the triangulation it is important to delete any empty models.

Select option *Models=>Delete=>Delete empty models*

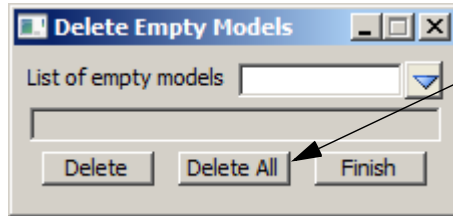

Select **Delete All**

This will delete the model **xbeaklines** and **unknown** which was created during the field file reduction

9.9.3 Triangulate data

All tinable data will now be triangulated. In this example we will triangulate a view of data. Turn off the model name **Trash model** if it exists. This model may have been created as a result of certain string edits. The edit panels may have given the user the option to send the affected string to the **Trash model**

Select option *Tins=>Create=>Triangulate data*

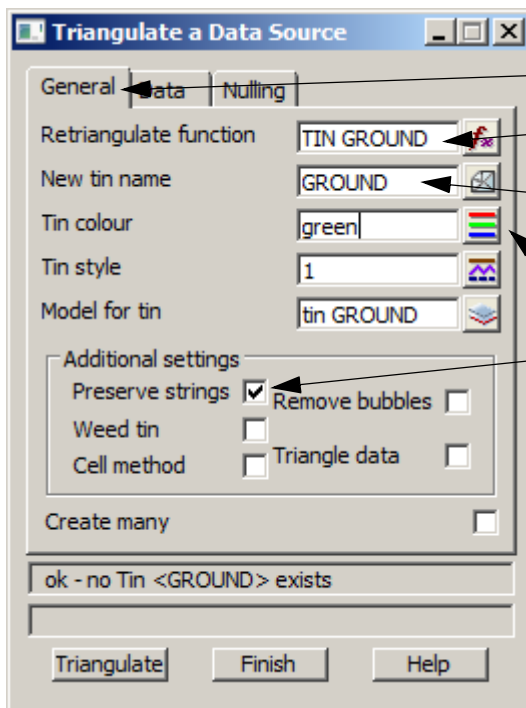

Select the **General** tab

Type in the function name **TIN GROUND**

Type in **GROUND** as the tin name. Press [Enter] and the **Model for tin** will use the same name prefixed with the word **tin**

Select a tin colour **green**

Tick the check box to **Preserve strings**. This will ensure that the triangles run along the edge of the breaklines

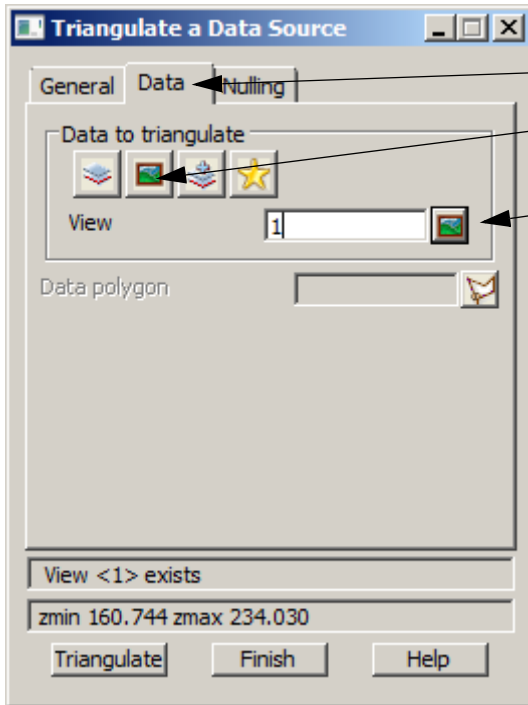

- Select the **Data** tab
- Select the view icon
- Select view 1

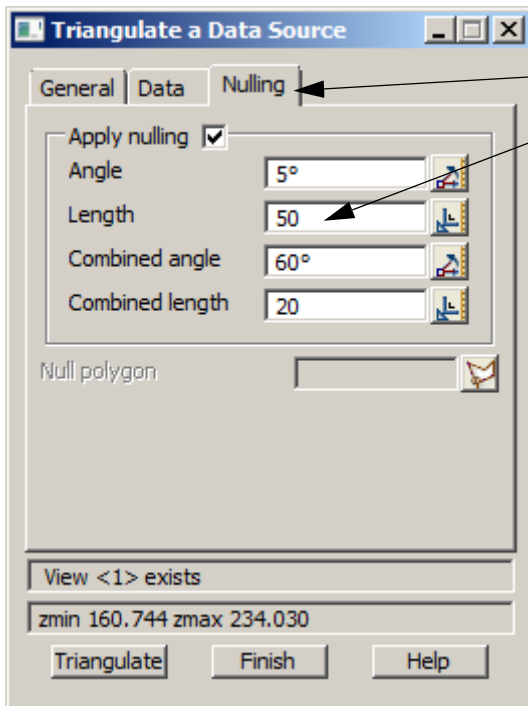

- Select the **Nulling** tab
- Type in a length of 50. This will delete any triangle with a side longer than 50
- The angle and combined length / angles are explained by pressing **Help**
- We are going to manually create a boundary at a later stage so there is no **Null polygon**

Select **Triangulate**

The panel changes to a **Retriangulate Tin** panel.

We will use this panel again later to select the tin boundary, so it can be minimised or moved over to the edge of the screen

Turn on the model **tin GROUND**

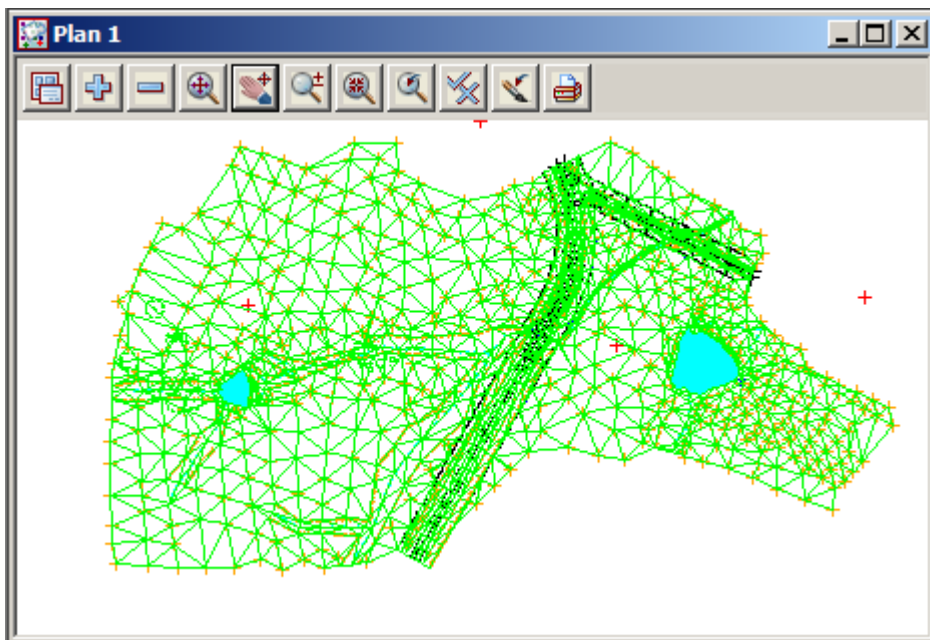

The triangulation is shown with preliminary nulling around the edge

9.9.4 Nulling Triangles

When deleting triangles it is important to be able to see the survey strings. As the tin was the last model turned on the green triangle lines cover the survey strings. We can put the green tin strings to the back by selecting **Menu** button on the plan view. Walk right on **Models=>Models to back** then select **tin GROUND**. This can also be done by walking right on **Models=>Models Order** and moving the tin model to the bottom of the list

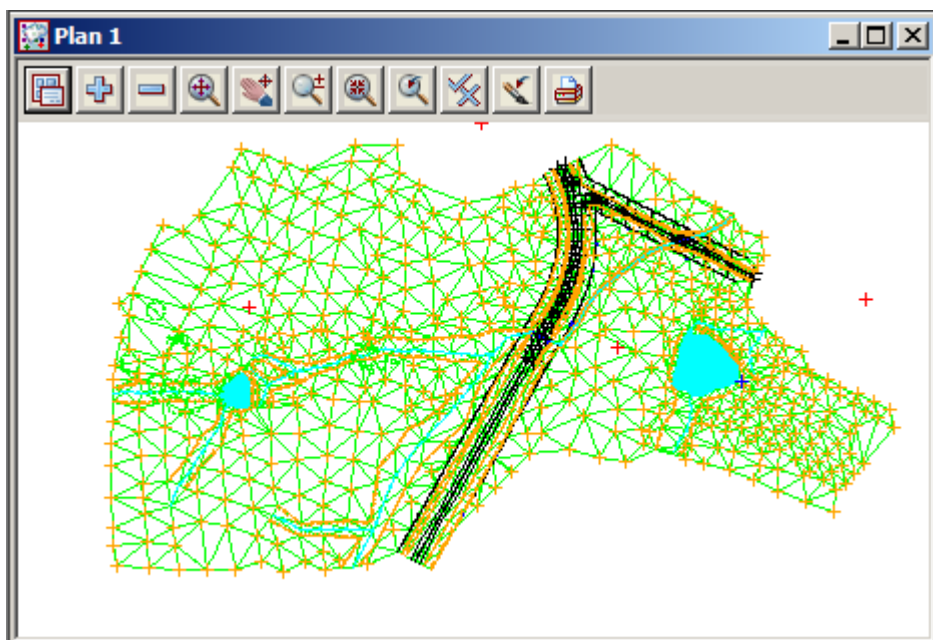

The triangles around the edge of the data have been partially nulled by the Triangulation function but we need to trim the triangles even further to be able to create a boundary around the edge of the survey.

There are a number of ways to null triangles including *Delete by angle/ length, by points and by strings*

Null triangles by angle and length

This option has been included in the tin creation so is not necessary if the relevant tab was filled in during the triangulation process

Null by strings

Triangles can also be deleted by dragging a line, polyline or lasso through the ones that are incorrect.

Select option *Tins=>Null=>By strings*

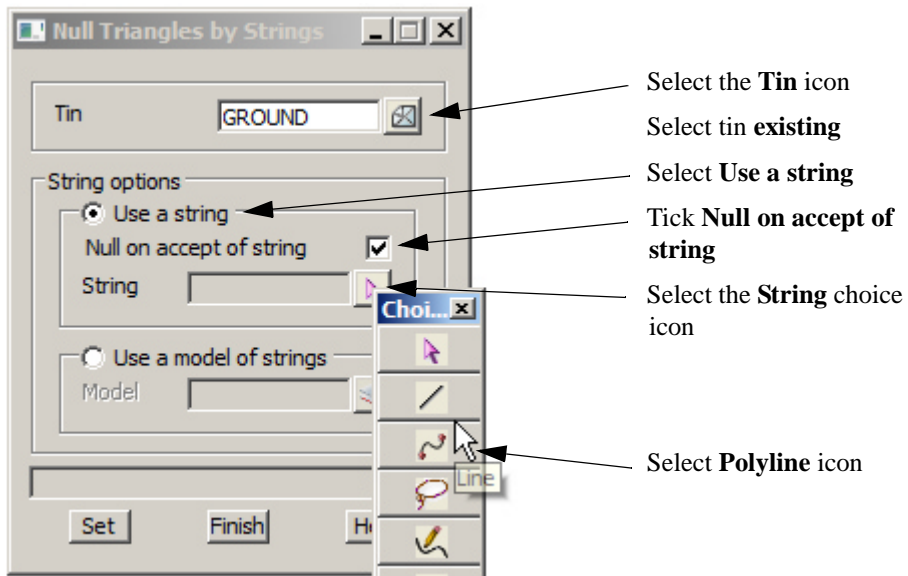

Zoom in to point 1482
These two triangles
need to be nulled

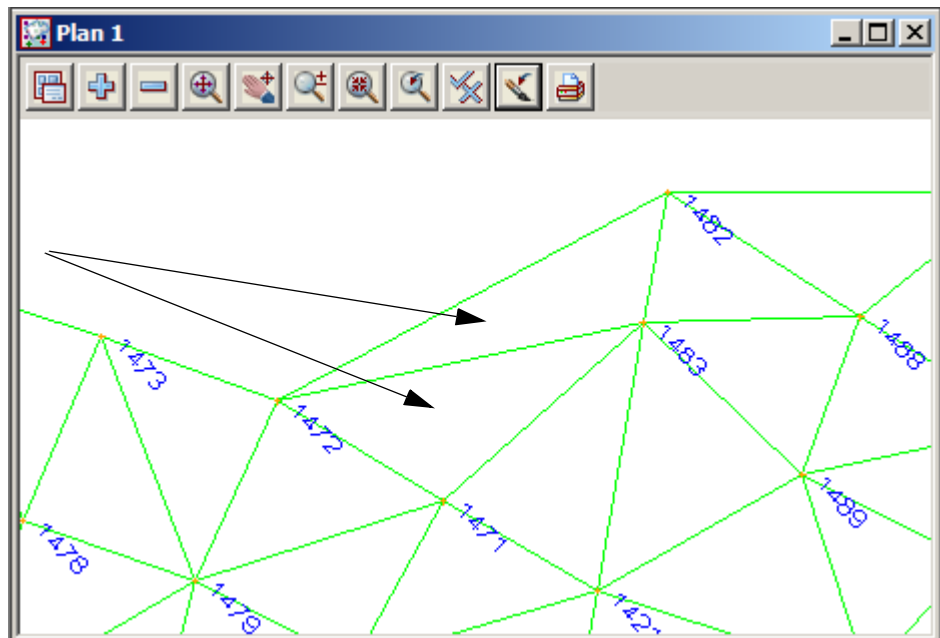

Holding down the left button, drag a polyline through the triangles as shown. Release the left button then press middle button to confirm the delete

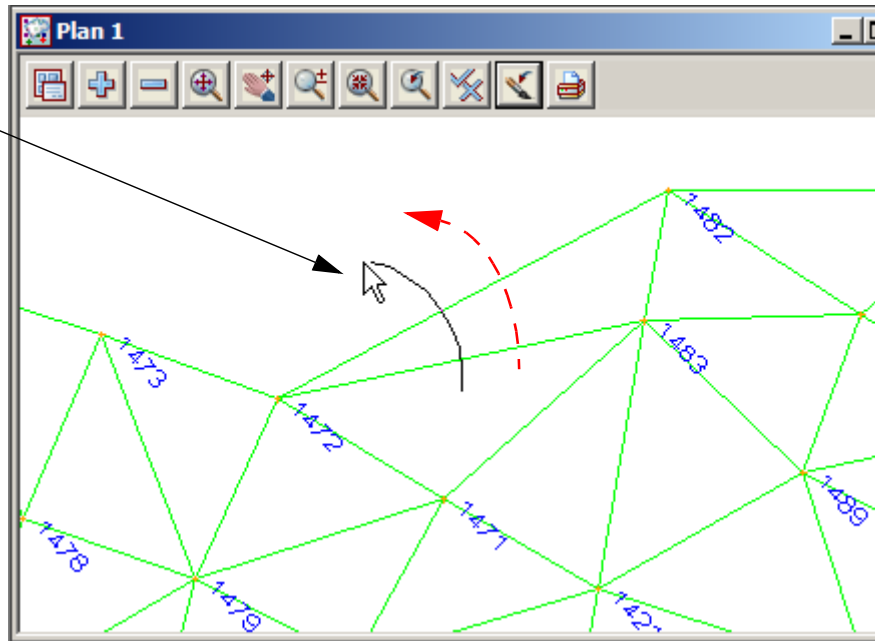

The triangles will be deleted

Pan around the edge of the survey deleting triangles in this manner

Pay particular attention to the triangles where the creek beds meet the boundary. The triangles often cross from one top of bank to the other.

The final trimmed triangles should look like the example below

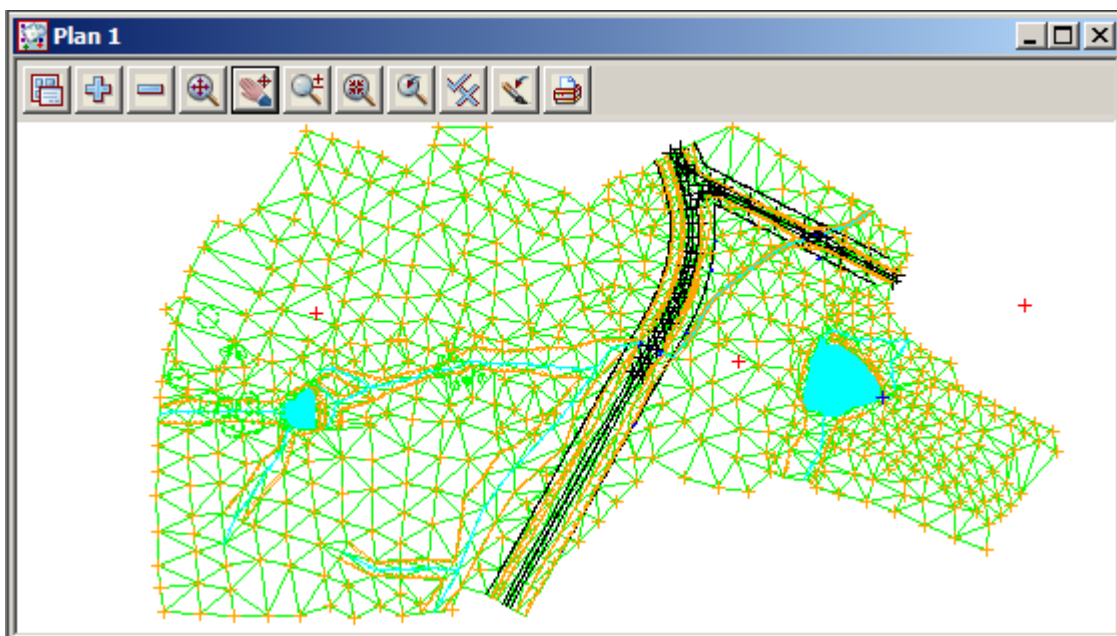
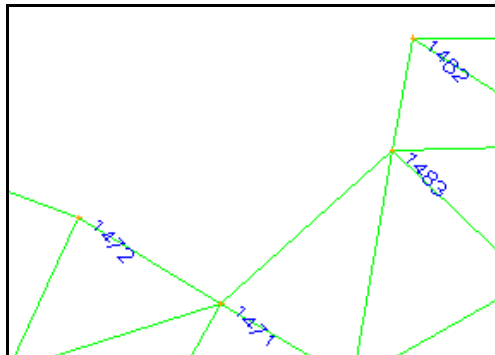

Tin Solid

To ensure there have been no errors while deleting the triangles, the surface can be coloured with a solid fill. This enables any errors to be easily seen

Zoom to the extents of the survey data

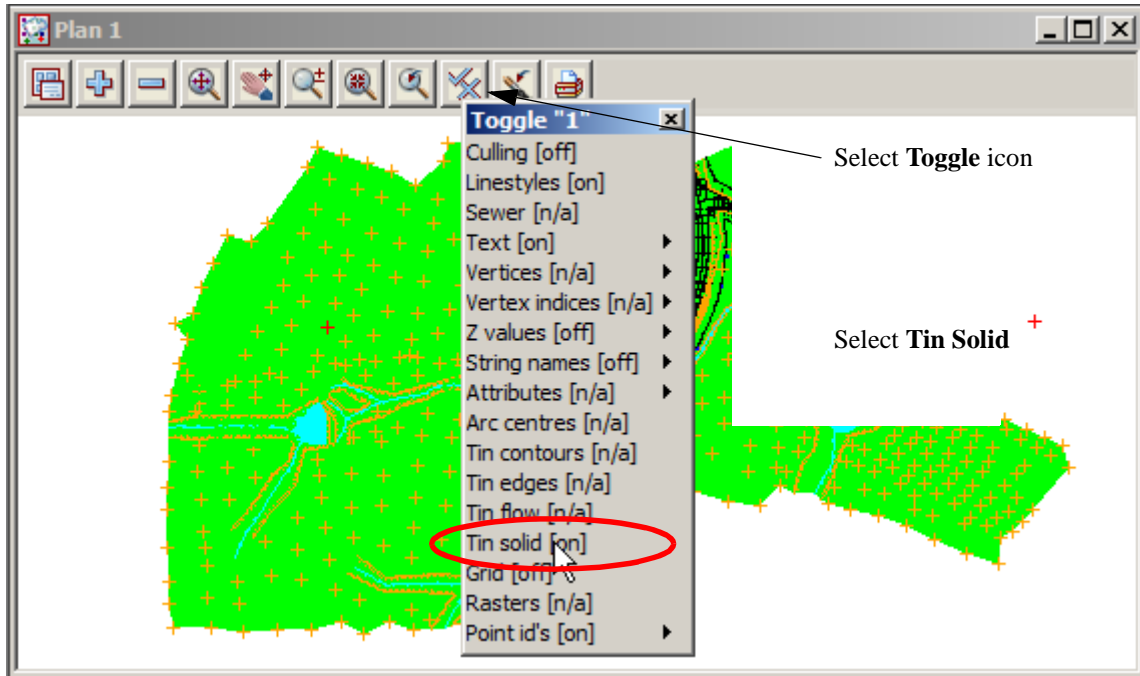

Reset triangles

To “Undo” a wrongly deleted triangle select the option *Tins=>Null=>By Points*

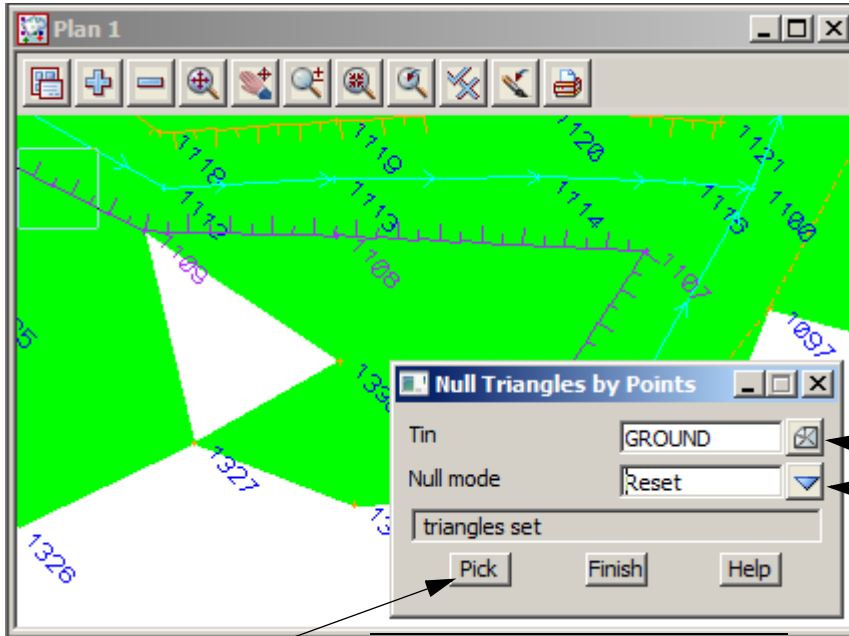

Select tin **ground**
 Change the **NULL** mode to **Reset**
Turn off the Line and Point snap

Select **Pick**

Select and accept the centre of the triangle to reinstate

The triangle will be restored as seen by the solid fill

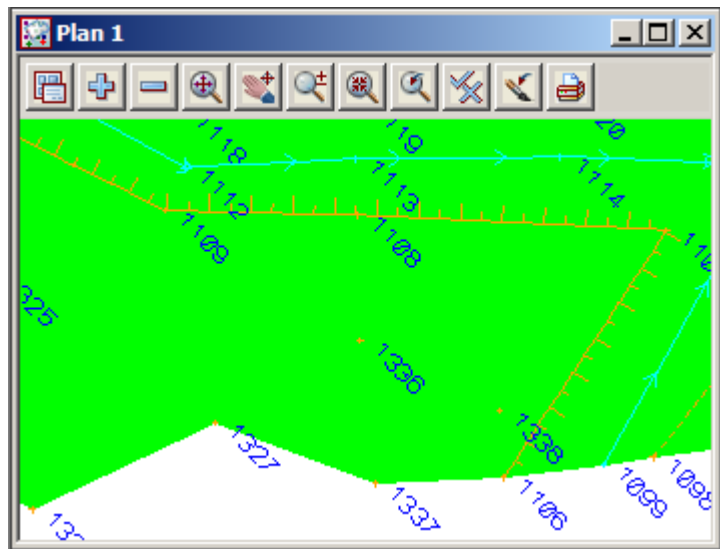

9.9.5 Tin Boundary

Once the triangles have been trimmed around the edge of the survey a string can be created along the extent of the triangulation. This is then used to nominate a Null polygon for the triangulation.

Turn on both point and line snaps

Turn off **Tin Solid**

Select the option *Tins=>Boundary*

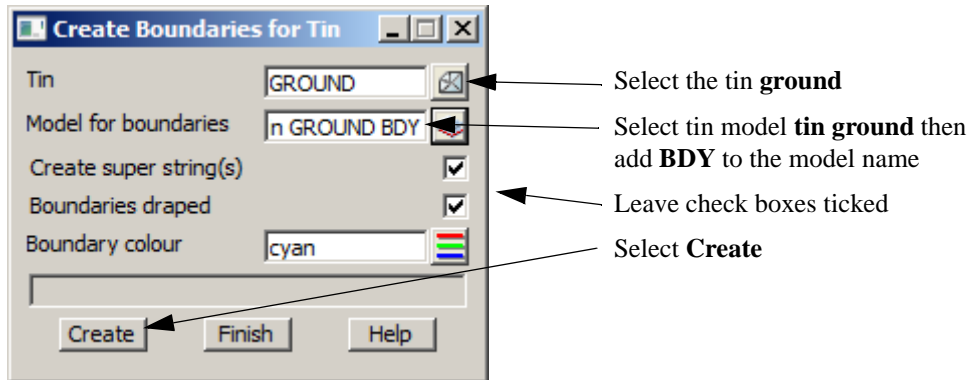

Turn on the model **tin GROUND BDY**

A cyan string is created around the extent of the triangulation

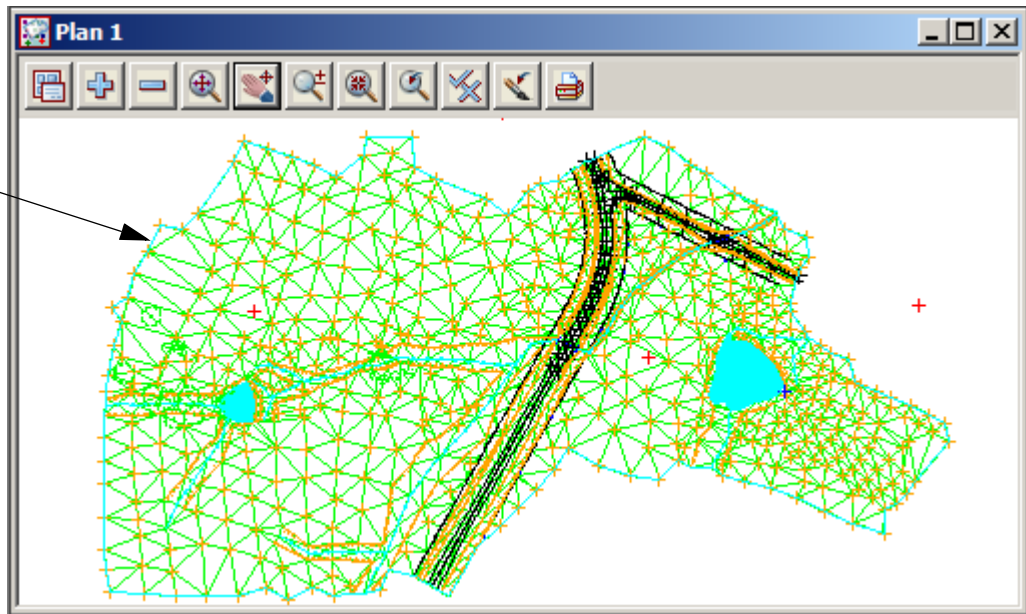

Now we need to include the boundary string in the triangulation

Return to the **Retriangulate Tin** panel

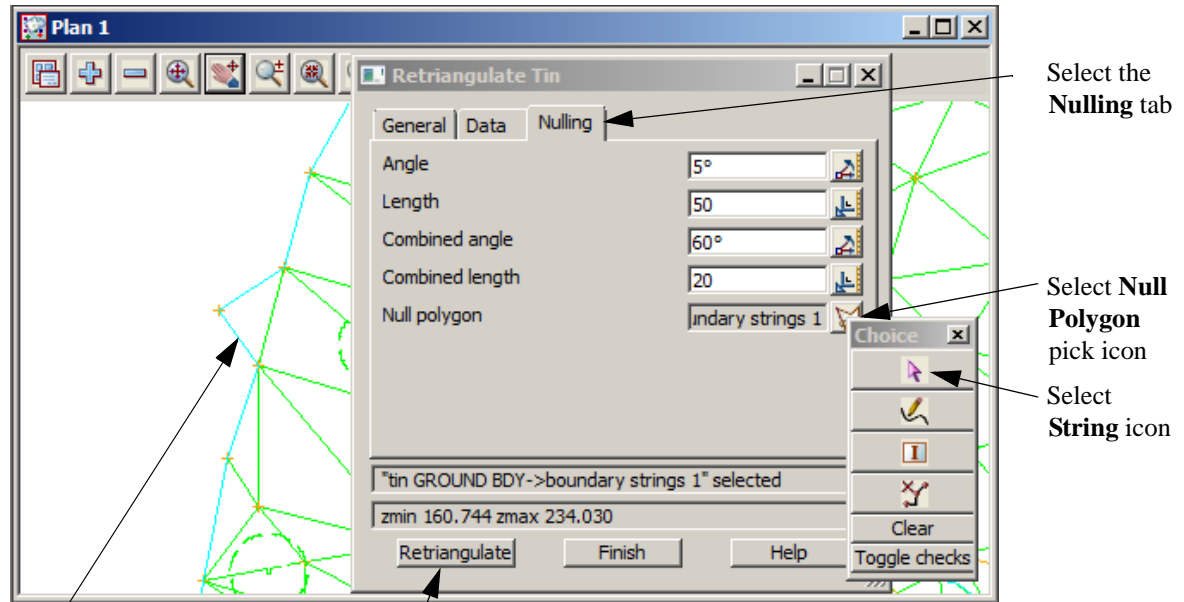

Select the **Nulling** tab

Select **Null Polygon** pick icon

Select **String** icon

Pick and accept the boundary string

Select **Retriangulate** then **Finish**

9.9.6 Viewing fast contours

We will now turn on the fast contours to analyse the triangulation.

Select **Toggle=>Tin Contours**

The contours should be checked for any errors

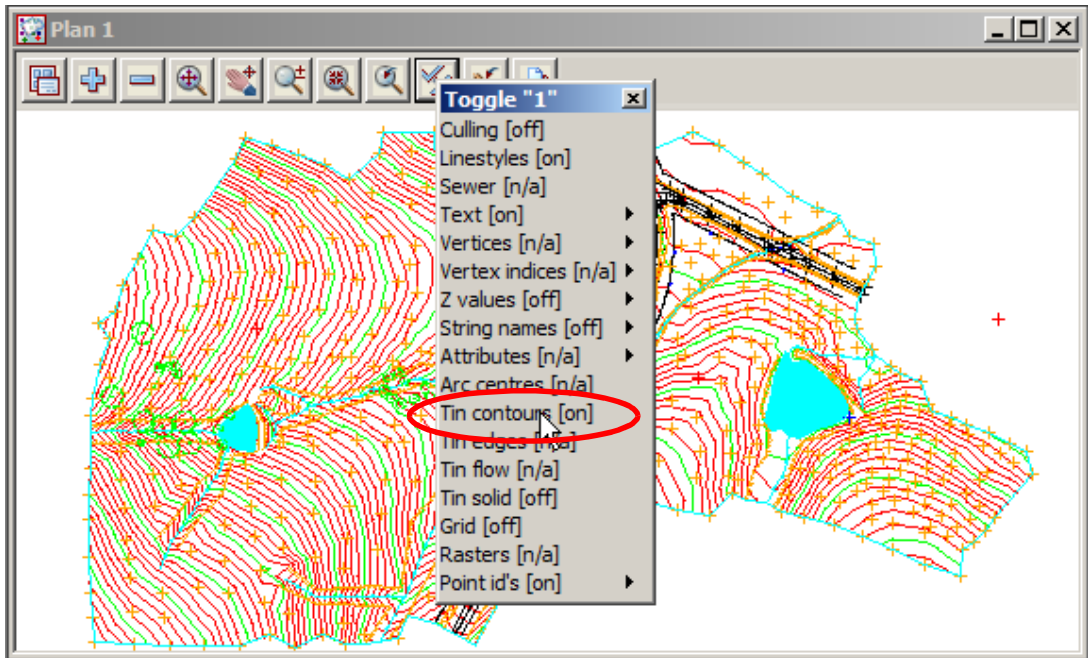

The contour increment can be changed for the view. Select the **Menu** icon

Walk right on **Settings =>Tins =>Contours** to bring up **Tin Draw Contours** panel

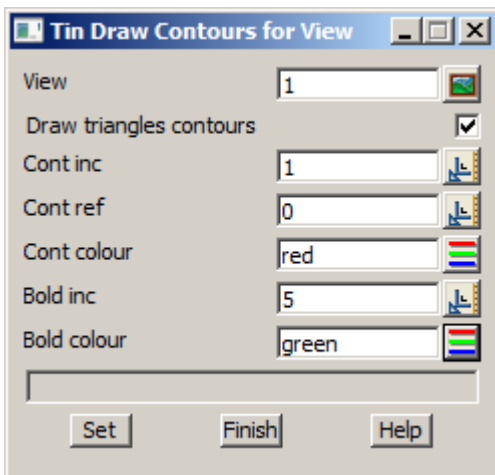

All features of the contours can be changed,

To update the triangulation select *Tins=>Edit=>Retriangulate=>GROUND*

Or recalc the function using the recalc panel

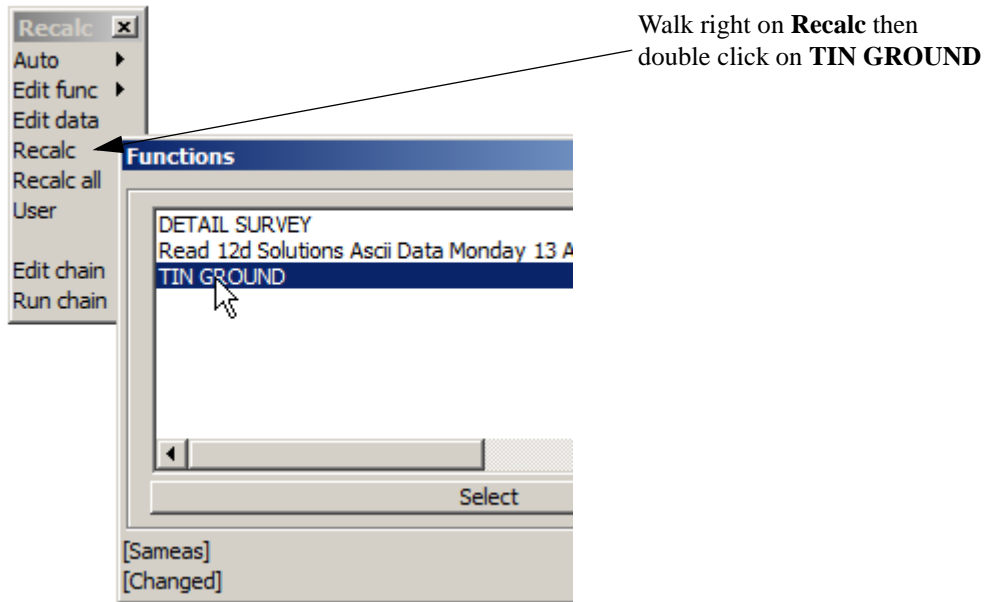

9.9.7 Perspective Views

To help analyse the triangulation a perspective view can be created. The surface can be shaded and viewed from any angle

To create a perspective view select **View=>New=>Perspective OpenGL**

Turn on all the models to be viewed

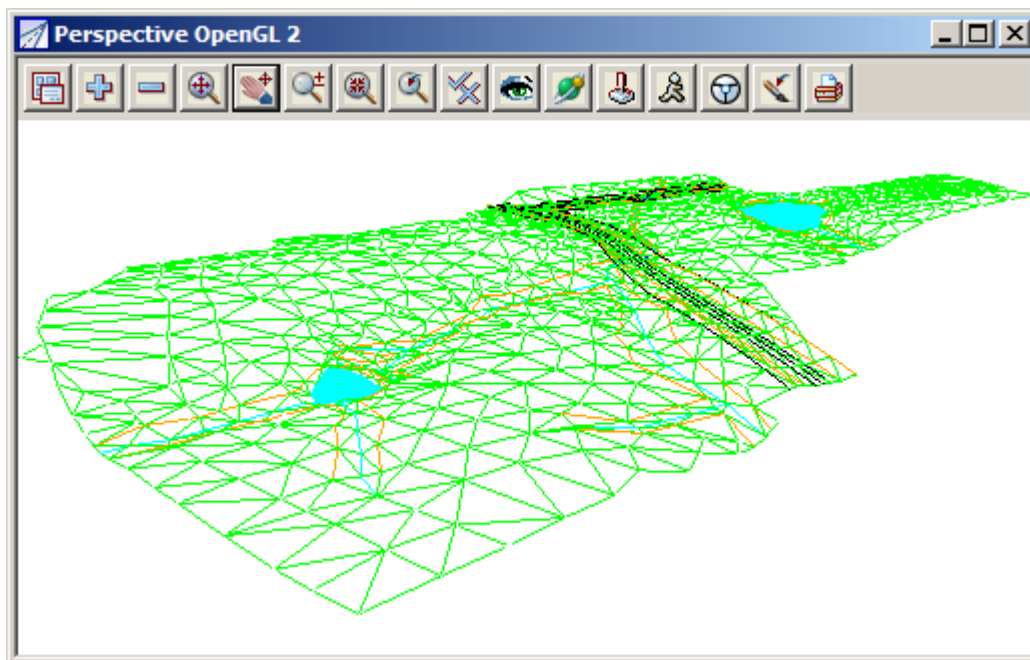
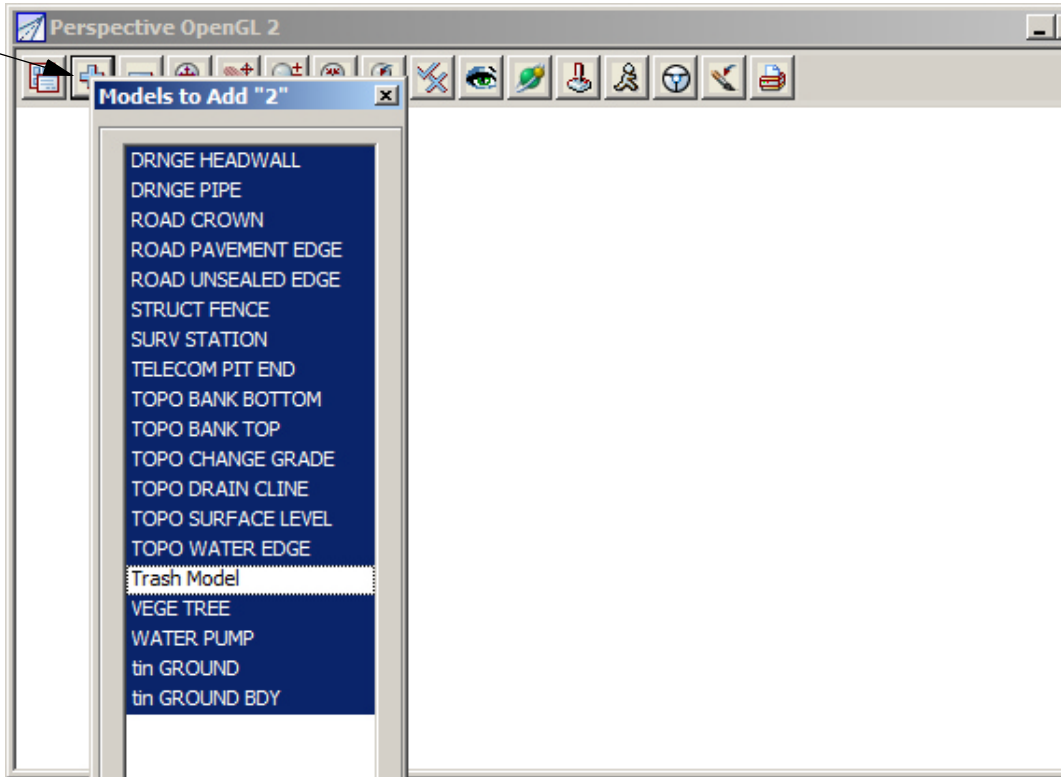

Shade the triangulation
 Select
Toggle=>Shade

 The triangulation is shaded.

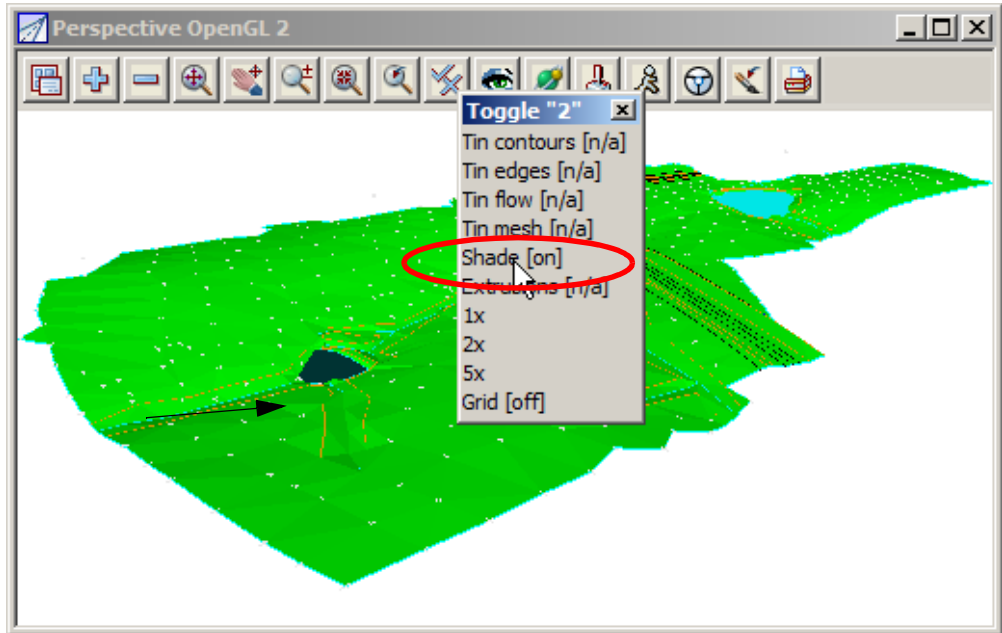

To move around the view select the *Orbit* icon

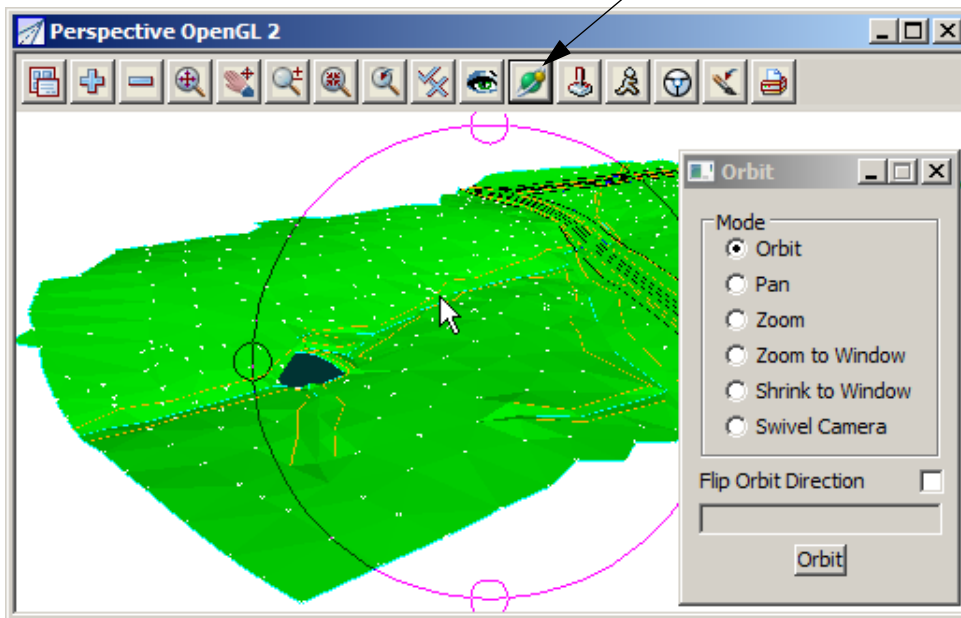

The panel defaults to the **Orbit** mode
 To use any of the options in this panel firstly select the option then simply move the cursor while holding down the left button

Close the perspective view

9.9.8 Section views

A section view can be created to view profiles along existing strings or to create dynamic sections through the survey

Select **View=>New=>Section**

Place the section view beside the plan view by selecting **Window=>Tile Vertical**

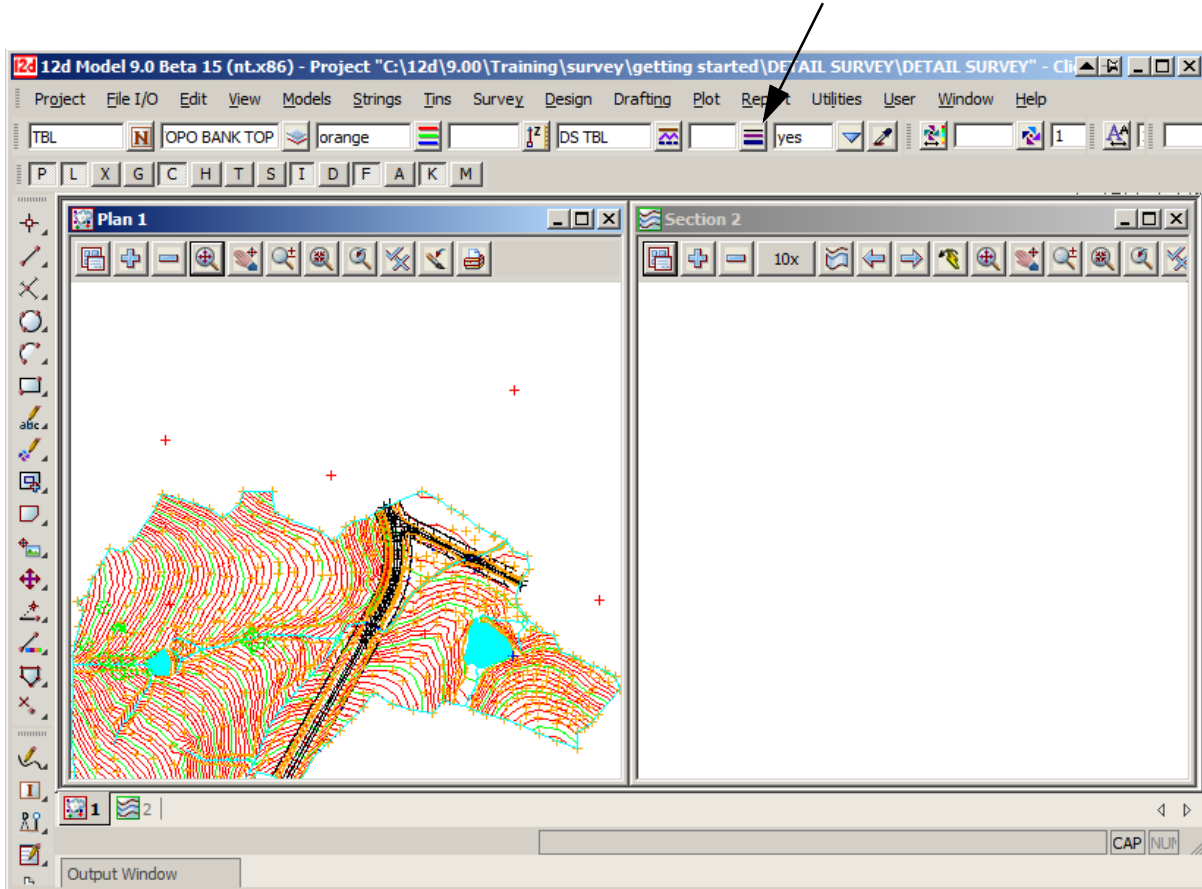

In the section view turn on model **tin GROUND**

Select **Profile** icon

Select and accept the crown of the road string
The profile of the string is displayed

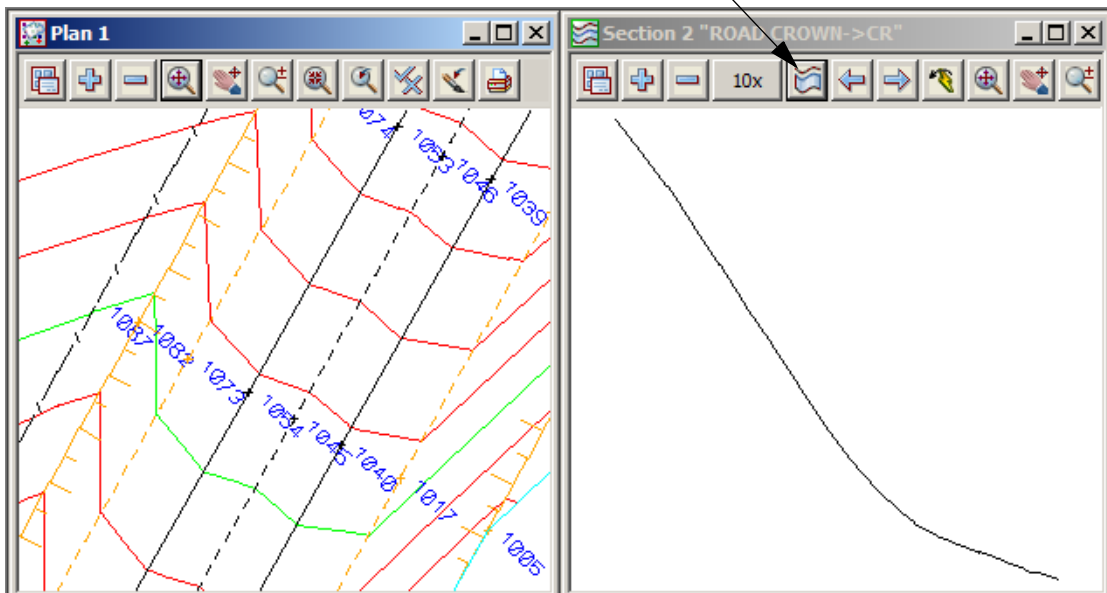

Now turn on the model **DRNGE PIPE** in the section view

Zoom in to point 2056 where the drainage pipe crosses the road

Select the **Vertical exaggeration** icon and set the vertical exaggeration to **2**

Zoom into the part of the section view to see the pipe under the ground

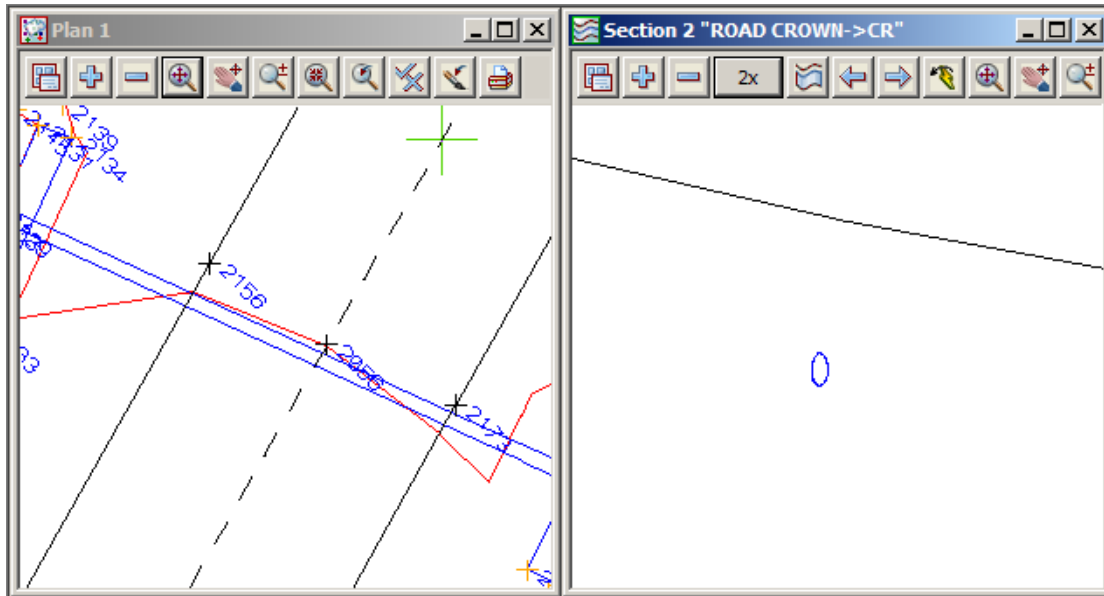

Close the section view

9.10 Plotting

9.10.1 Create New Plan View

We will firstly create a new plan view on which the data will be set up for plotting.

Select option **View=>Create=>Plan View**

Type in the name **Plot**

Select **Create**

Maximise the view

Turn on all models to be plotted

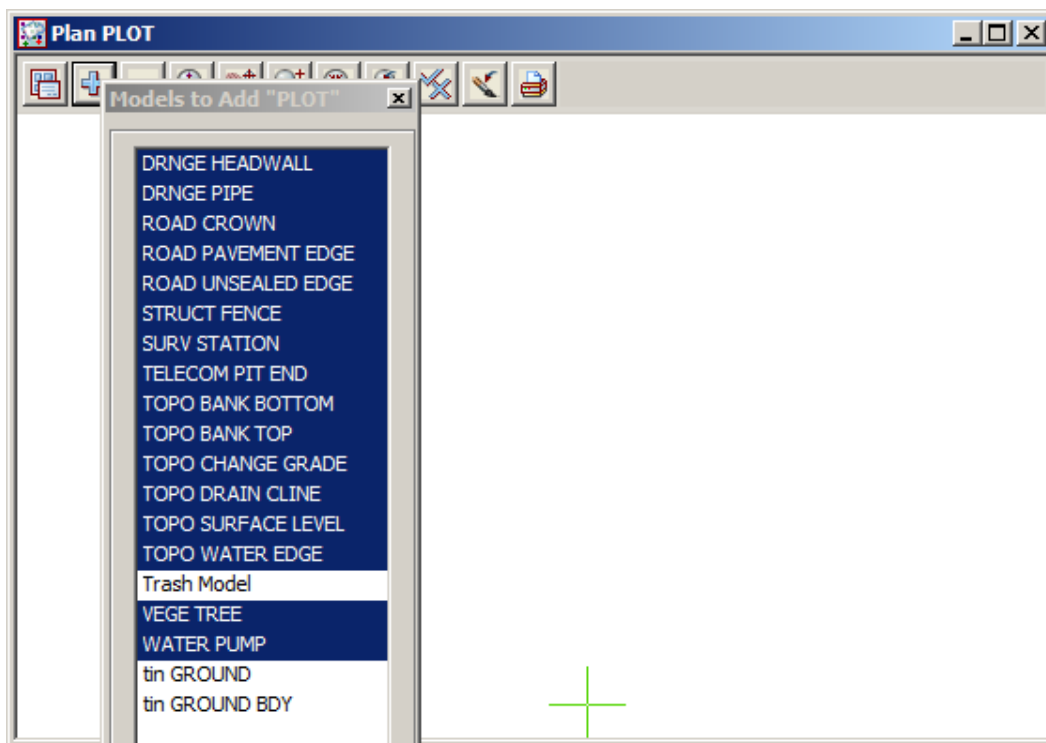
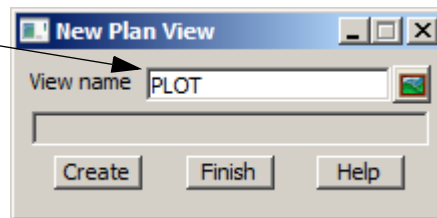

Zoom to the extents of the survey data

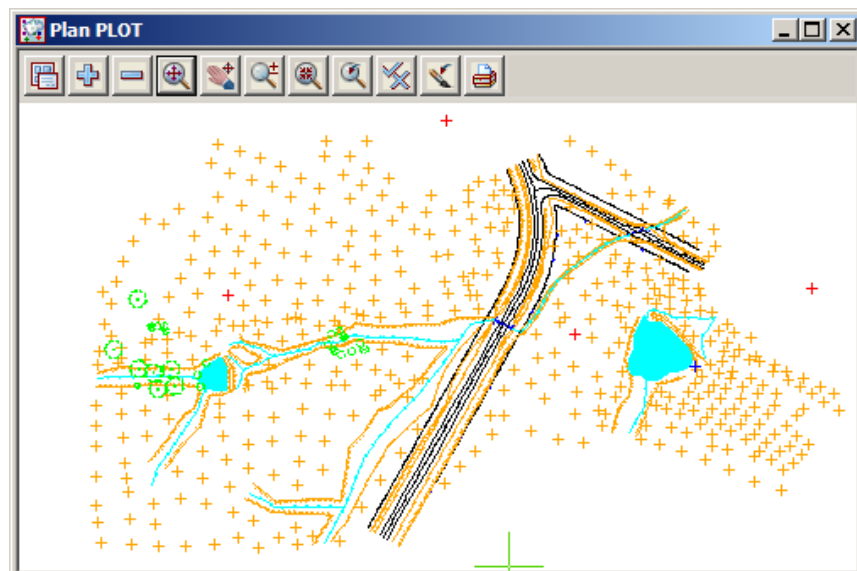

9.10.2 Feature labelling

The points in the survey can be labelled according to their names (codes). Labelling can be text such as **heights, codes and point numbers**

Firstly we will look at the label map file

Select option *File I/O=>Label Map File*

Select the Label map file folder icon

Select the file **TRAINING.imf** from the User_lib folder

Select **Read**

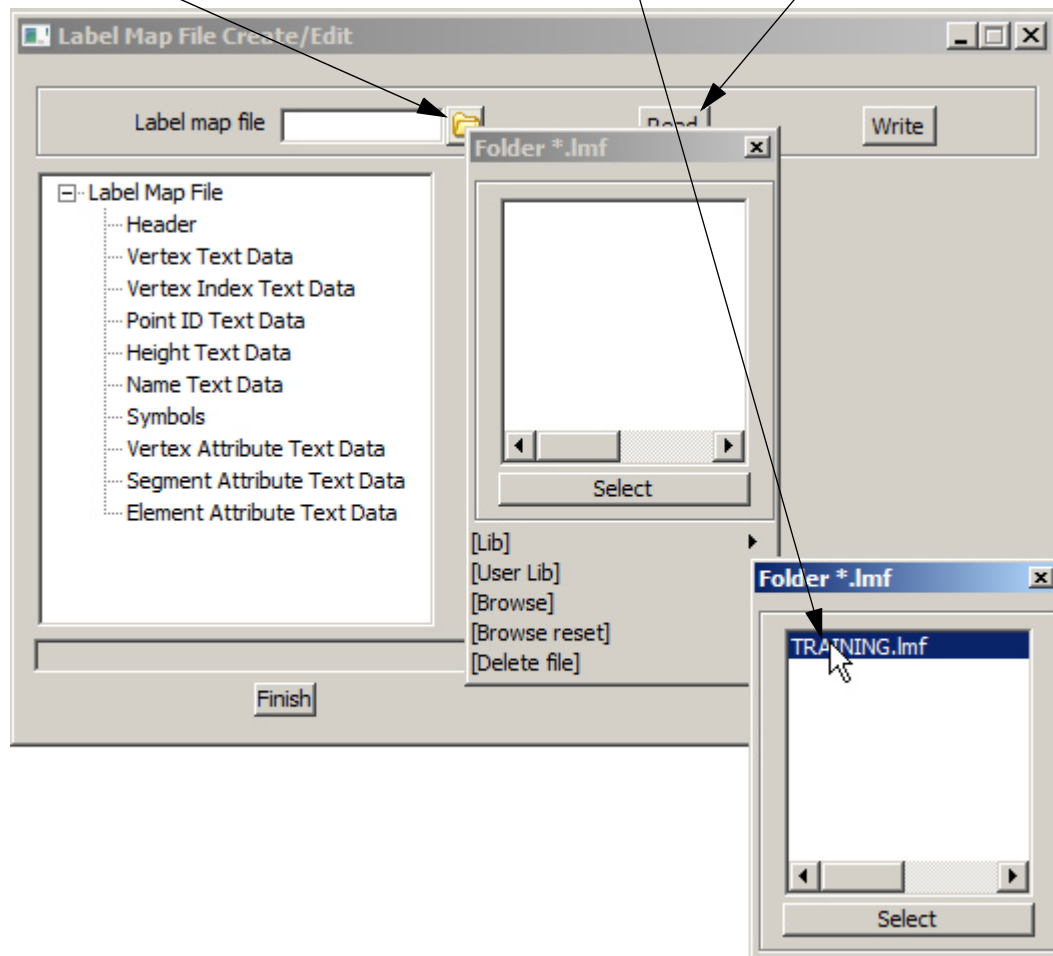

Select the **Height Text Data** branch

	Key	Textstyle	Type	Size	Colour	Angle	Offset	Raise	Slant	X Factor	Justify	Width	Precision	Prefix	Suffix	Label name	Comment
1	BB	ISO	paper	2	white	0°	0.5	0.5	0°	1	bottom-left		3				Bottom bank
2	CG	ISO	paper	2	white	0°	0.5	0.5	0°	1	bottom-left		3				CHANGE GRADE
3	CR	ISO	paper	2	white	0°	0.5	0.5	0°	1	bottom-left		3				CROWN ROAD
4	ER	ISO	paper	2	white	0°	0.5	0.5	0°	1	bottom-left		3				UNSEALED ROAD
5	ES	ISO	paper	2	white	0°	0.5	0.5	0°	1	bottom-left		3				SEALED ROAD
6	FE	ISO	paper	2	white	0°	0.5	0.5	0°	1	bottom-left		3				FENCE
7	SL	ISO	paper	2	white	0°	0.5	0.5	0°	1	bottom-left		2				SURFACE LEVEL
8	STN	ISO	paper	2	white	0°	0.5	0.5	0°	1	bottom-left		3				SURVEY STATION
9	SWE	ISO	paper	2	white	0°	0.5	0.5	0°	1	bottom-left		3	IL			DRAINAGE PIPE 0.
10	SWG	ISO	paper	2	white	0°	0.5	0.5	0°	1	bottom-left		3	IL			DRAINAGE PIPE 0.
11	TBL	ISO	paper	2	white	0°	0.5	0.5	0°	1	bottom-left		3				TOP BANK (BOTTO
12	TBR	ISO	paper	2	white	0°	0.5	0.5	0°	1	bottom-left		3				TOP BANK (BOTTO
13	WL	ISO	paper	2	white	0°	0.5	0.5	0°	1	bottom-left		3				EDGE WATER
14																	

For each code the feature can have user defined text parameters including **text style, unit type, size, colour, rotation angle, offset from insertion point in x and y distances, slant, width, justification, number of decimal places and prefix or suffix text.**

The other lines can be filled in in a similar manner

Select **Finish** to exit the editor

To label the data select **File I/O=>Use Label Map File**

Select the **View** icon

Select the **View Plot**

Select the Label map file **TRAINING.lmf** from the User_lib folder

If the **Use models for labels** check box is clear then the user is prompted for a model prefix so that each label is placed in a separate model

Clear the check box

Type in **txt ptno** as prefix for height models

Type in **txt ht** as prefix for height models

Type in **txt cd** as prefix for code models

Note that a space was placed after the prefixes above

Select **Label**

Prior to turning on the label models we need to delete any empty models (models with no data) created with this option. This is done by selecting option **Models=>Delete=>Delete Empty Models**

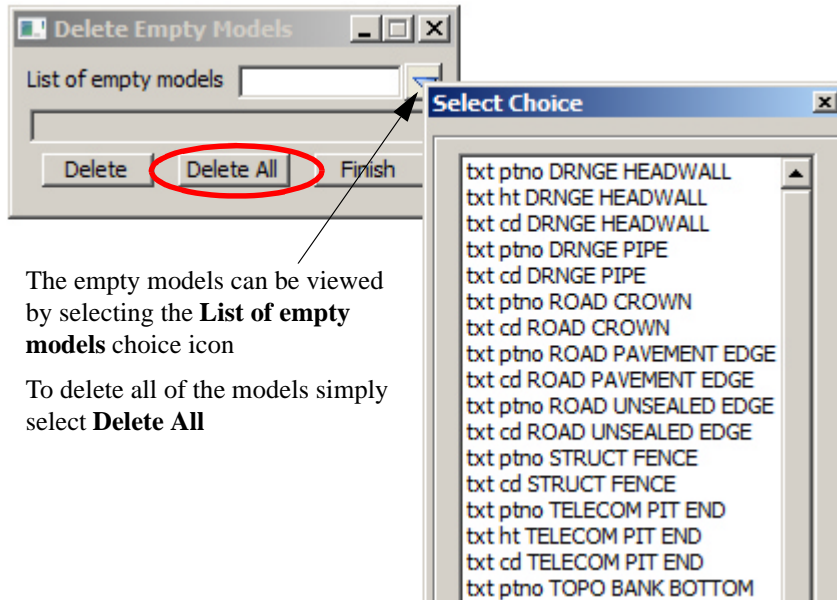

The empty models can be viewed by selecting the **List of empty models** choice icon
 To delete all of the models simply select **Delete All**

Turn on all the label models

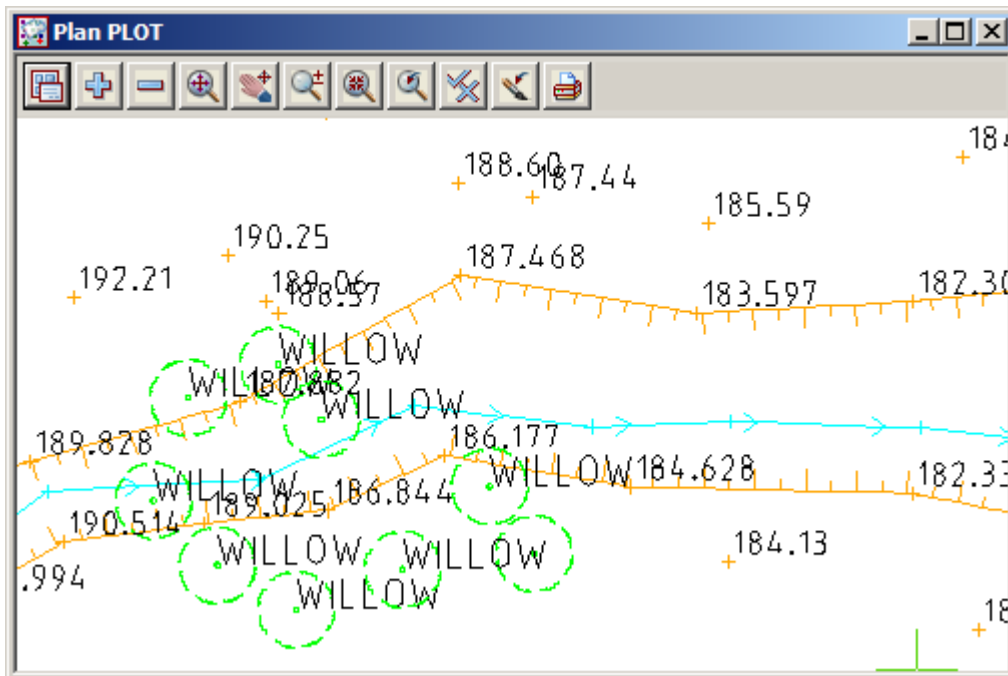

9.10.3 Setting the correct plot scale for the view

The plot is to be done at a scale of 1:500 so to view the paper unit text in the correct scale we need to set the view plot scale

Select the **Menu** icon. Walk right on **Settings=>Plotting Scale**

Type in scale **500**

Select **Set** then **Finish**

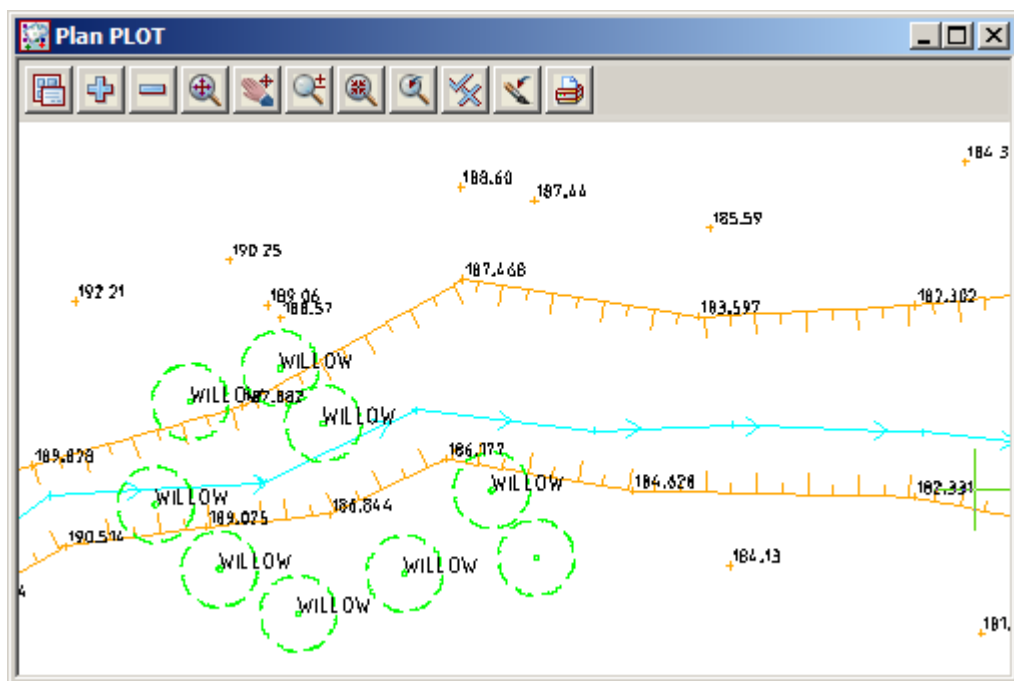
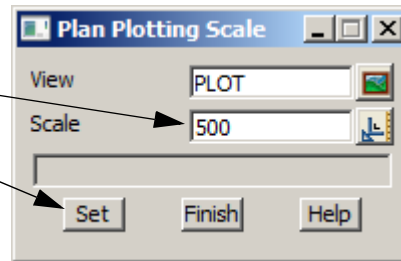

You will notice the labels are now smaller and reflect the correct scale when plotting

9.10.4 Creating Contours

The contour lines displayed in plan view 1 are “fast contours”.

The fast contours are not editable features and don't have labels

To create contours select *Tins=>Contour=>Contour, Smooth and Label*

The screenshot shows the 'Tin: Contour, Smooth and Label' dialog box. The 'Function name' field contains 'CONTOUR GROU' and the 'Tin to contour' field contains 'GROUND'. The 'Contours' tab is selected. The 'Model for contours' field contains 'contours' and the 'Contour increment' field contains '1'. The 'Colour' field contains 'red'. The 'Smooth contours' checkbox is checked. The 'Preserve string points' checkbox is unchecked. The status bar at the bottom indicates 'Function <CONTOUR.GROUND> will be created'. Annotations with arrows point to the following elements:

- Type in function name **CONTOURS GROUND**
- Select **Tin to contour** choice icon then select tin **ground**
- Select the **Contours** tab
- Type in **contours** for Model name
- Type in contour interval **1**
- Select colour **red**
- Tick the **Smooth contours** box

The screenshot shows the 'Major Contours' tab of the dialog box. The 'Create major contours' checkbox is checked. The 'Model for major contours' field contains 'contours major' and the 'Major contour increment' field contains '5'. The 'Colour' field contains 'magenta'. Annotations with arrows point to the following elements:

- Select the **Major Contours** tab
- Type in **contours major** for Model name
- Type in contour interval **5**

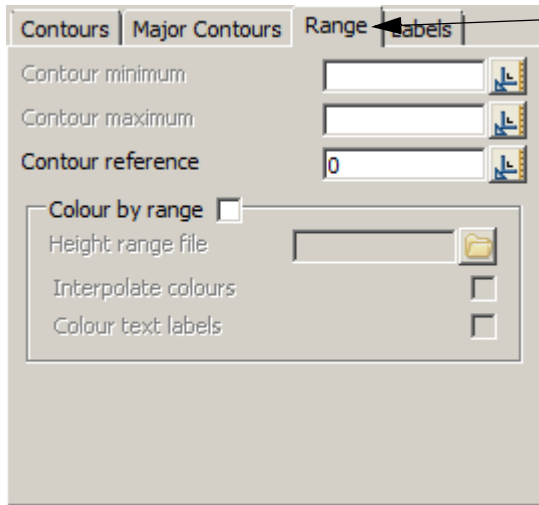

Select the **Range** tab

Leave this panel unaltered

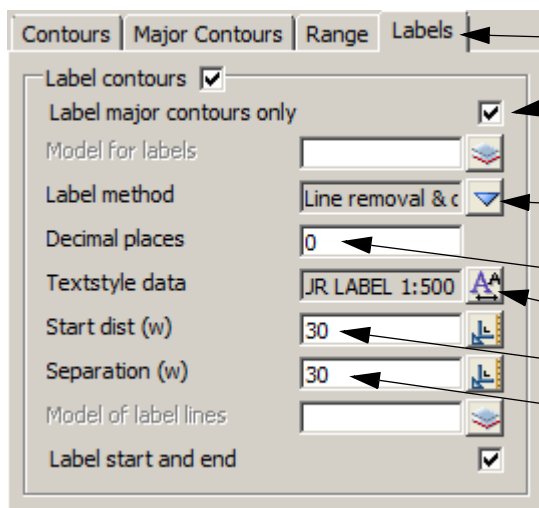

Select the **Labels** tab

Tick check box to **Label major contours only**

Select label method **Line removal and centred line facing uphill**

Type in **0** for number of decimal places

Select textstyle **Contour label 1:500**

Type in start distance of **30**

Type in separation of **30**

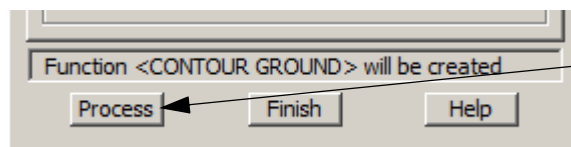

Select **Process**

Don't press Finish until you have verified the contour labelling

Turn on the newly created models **contours** and **contours major**

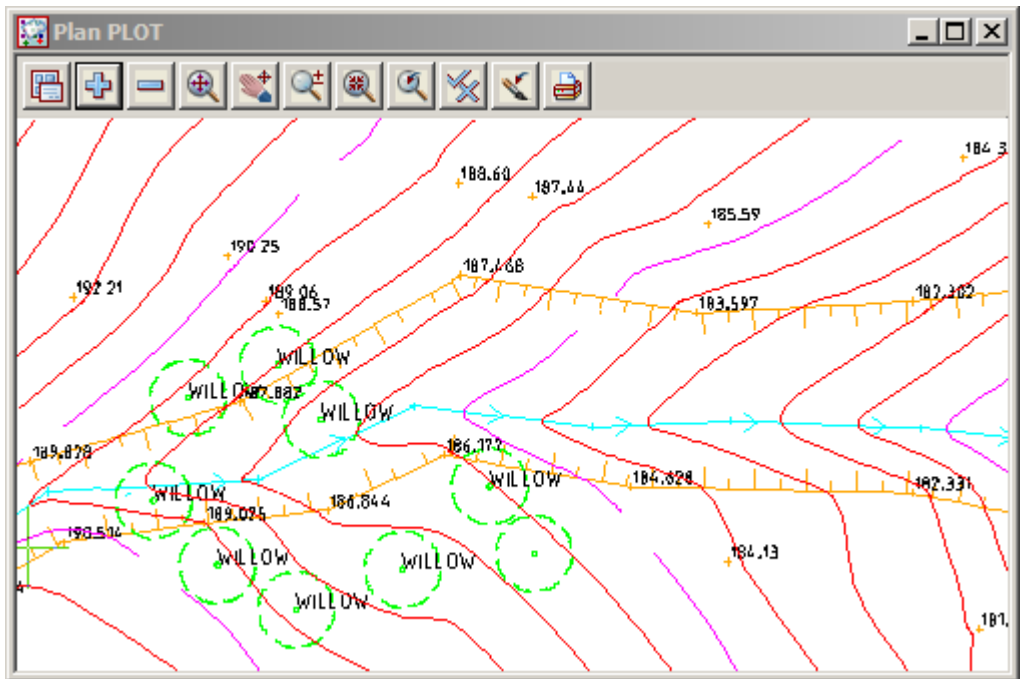
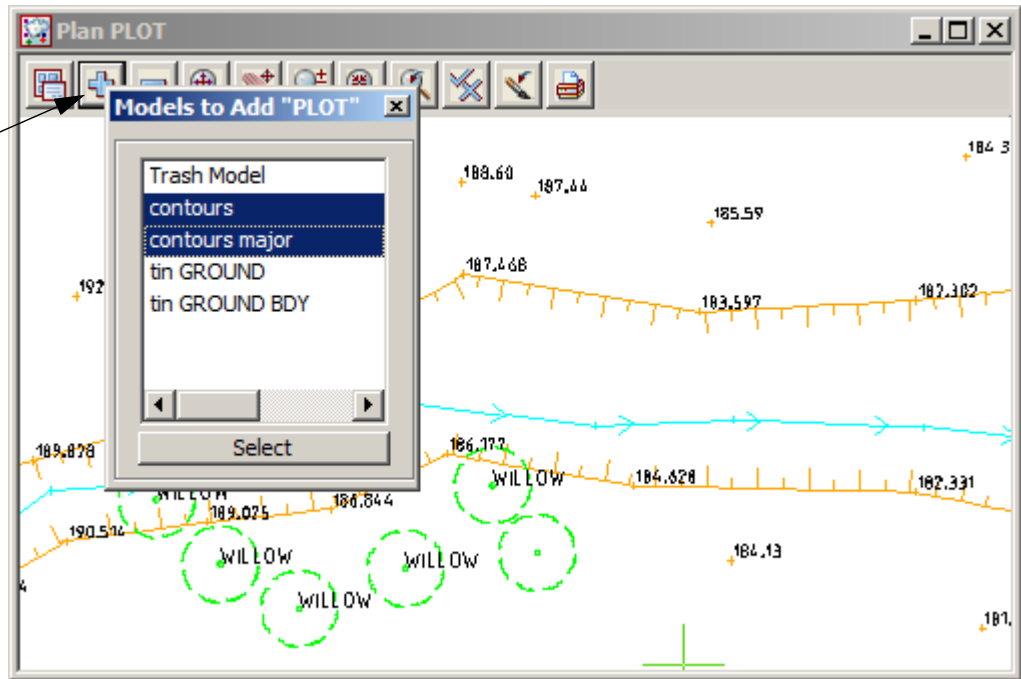

9.10.5 North Point

To place a North Point in the survey plot select option *Drafting=>North arrow*

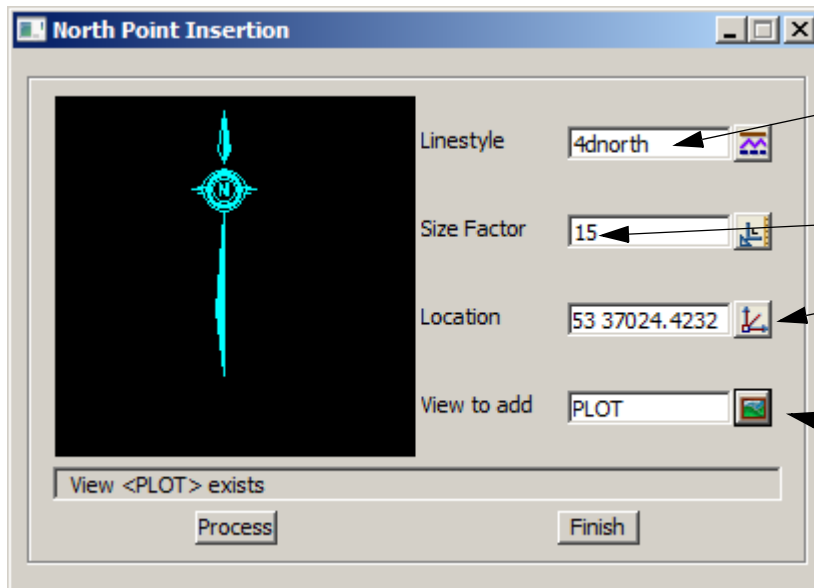

The linstyle **4dnorth** is set as the default

Type in a **Size Factor** of **5**

For **Location** select icon then pick and accept the position for the north point

Select view **Plot** for view to add North arrow

Select **Process** then **Finish** to create the north arrow

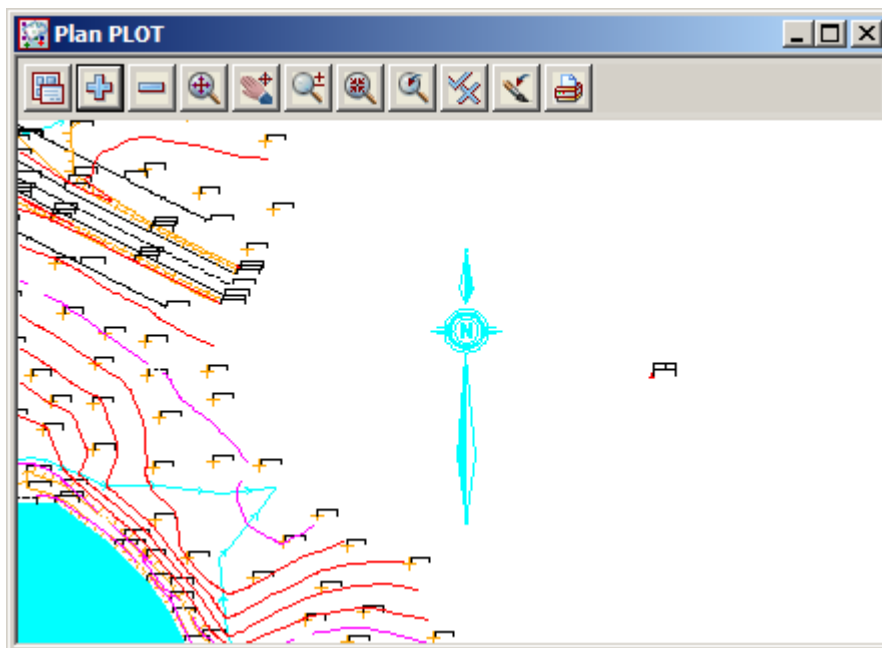

9.10.6 Text Editing

In this section we will add new text and edit existing text

Adding text

Text can be added to the view to describe features.

Firstly we need to set the default text attributes.

Select **Names** icon

Select **.TEXT ROAD NAMES** to set the properties to the cad control bar and the text control bar

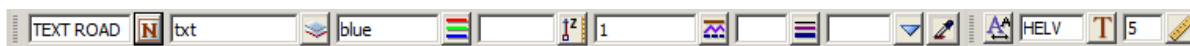
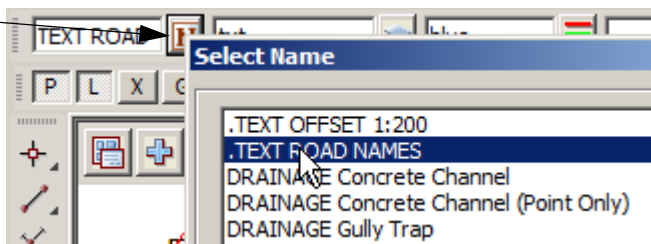

The text toolbar can be displayed and moved to the edge of the screen

Select *View=>Toolbars*

Tick the **Cad Text** check box

Select **Close**

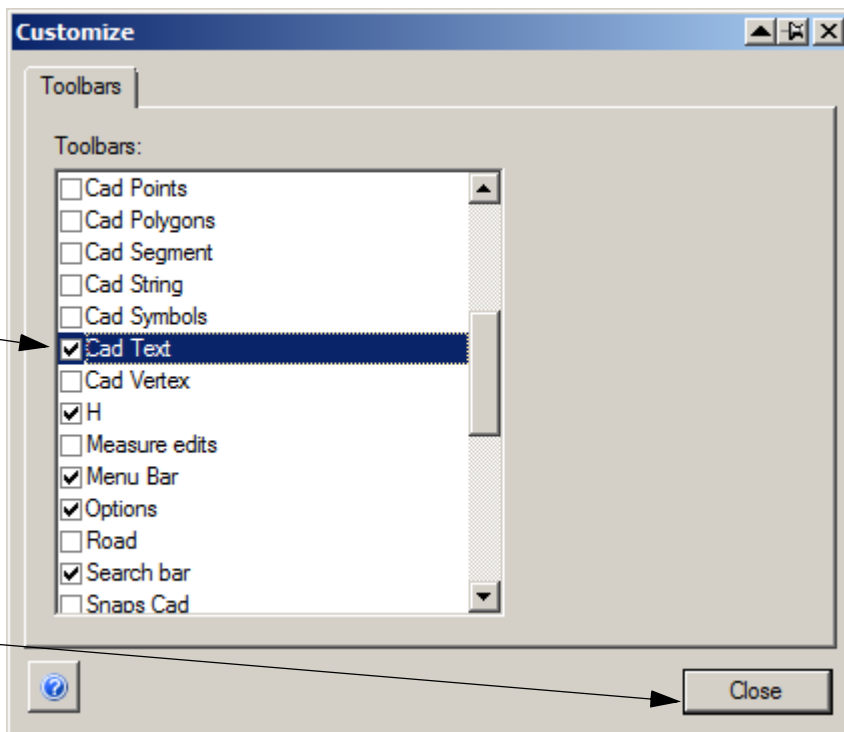

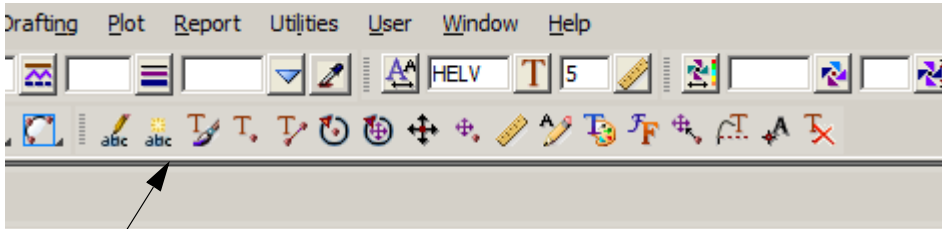

Drag the text toolbar up to the top of the screen and dock in the menu area

Select the **Create simple text** icon



Select and accept the insertion point of the text

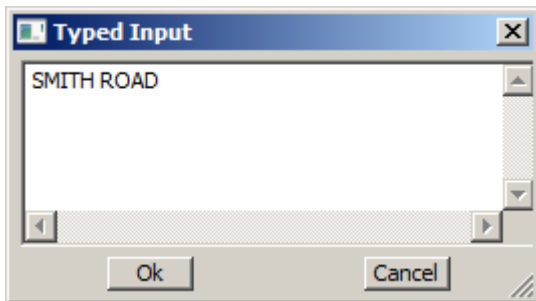

Type in the required text **SMITH ROAD** then press [OK]

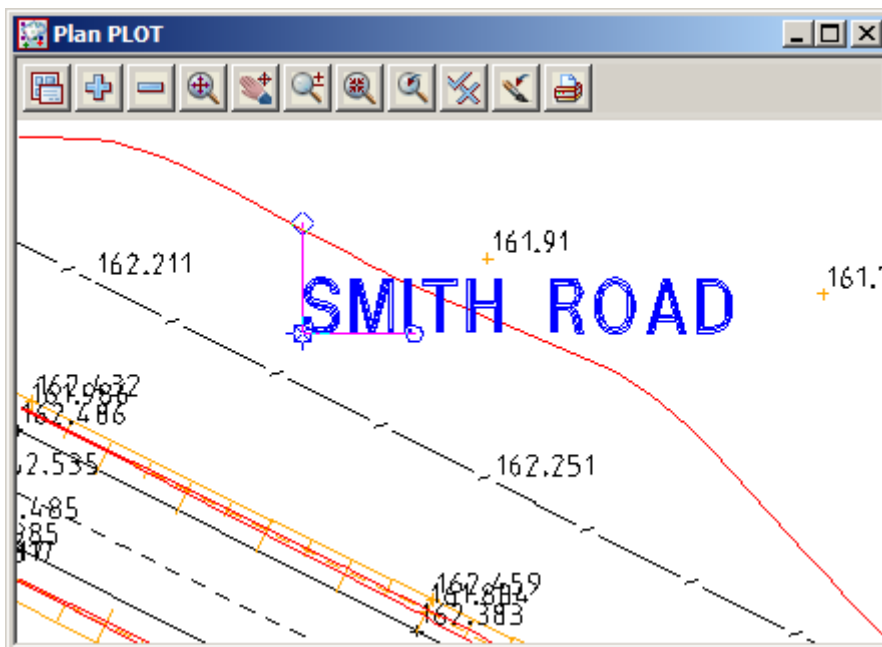

The text appears on the screen with three nodes at the start of the text. These are used to move, rotate and scale the text
Press [Escape] to finish the text placement

Editing text

We will now look at editing the text using the nodes

Select the **Edit simple text** icon



Select the piece of text to edit.

Scaling text

Pick and accept the top left node

As you move the cursor the text is resized. Accept with middle button

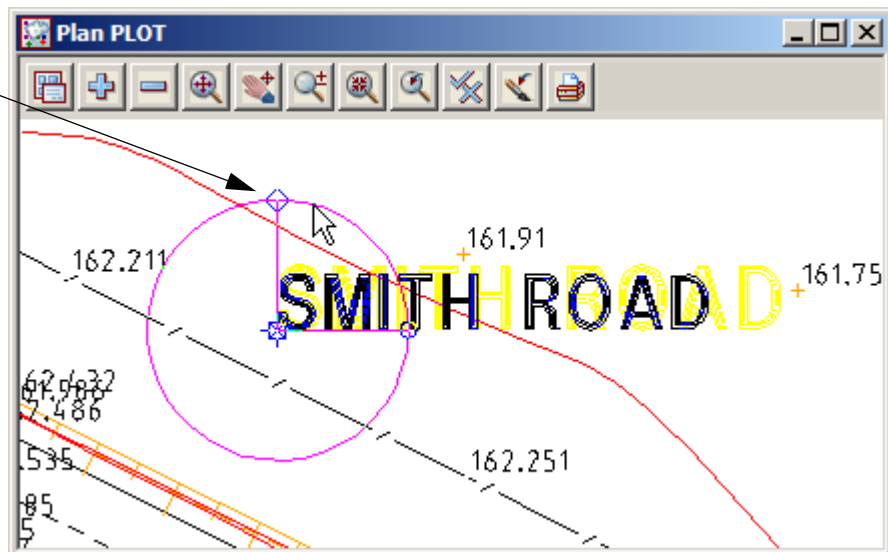

To type in a text size simply type in the value and press [Enter]

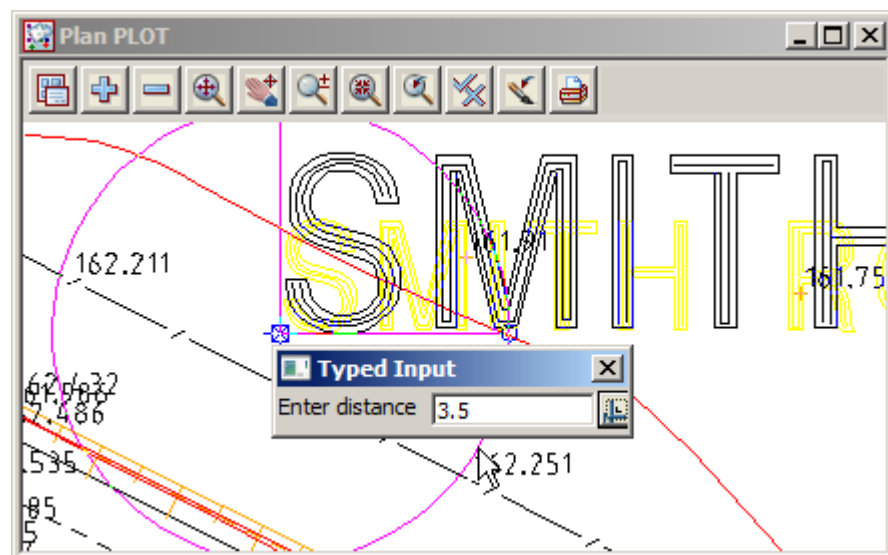

Moving text

Pick and accept the bottom left node

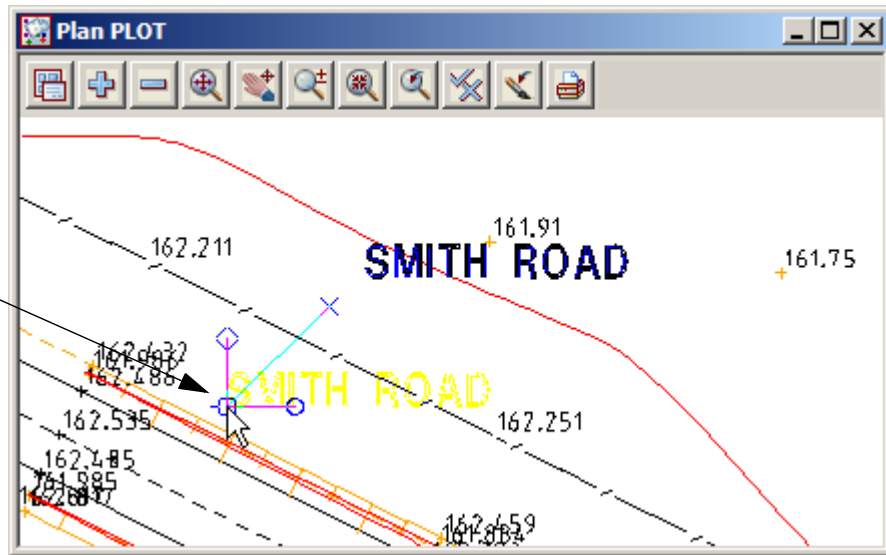

As you move the cursor the text moves. Pick and accept the new position

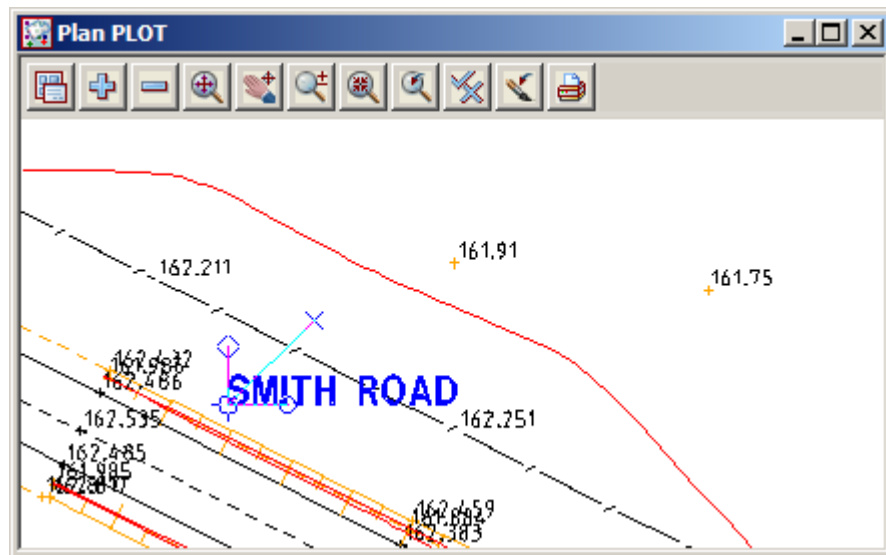

Rotating text

Pick the bottom right node

As you move the cursor the text rotates. Accept with middle button

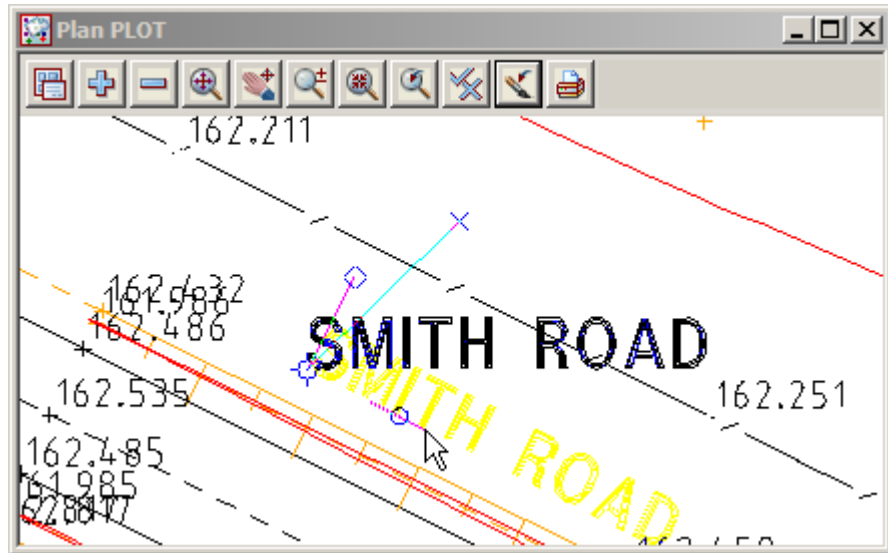

To rotate to a set angle simply type in the value and press [Enter]

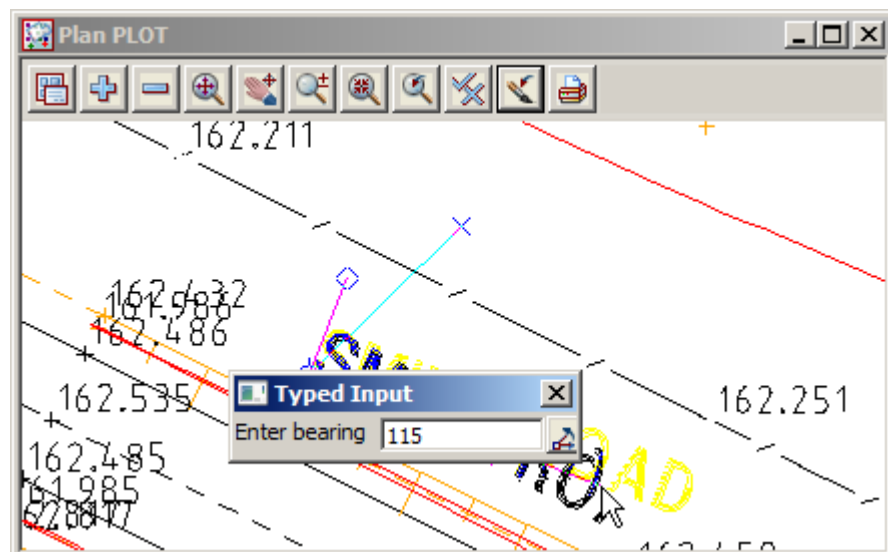

Additional keystrokes displayed at the bottom of the screen can be used to rotate tangential or perpendicular to a selected string

In the example here the key **T** was pressed and the fence string was picked to align the text to the fence line

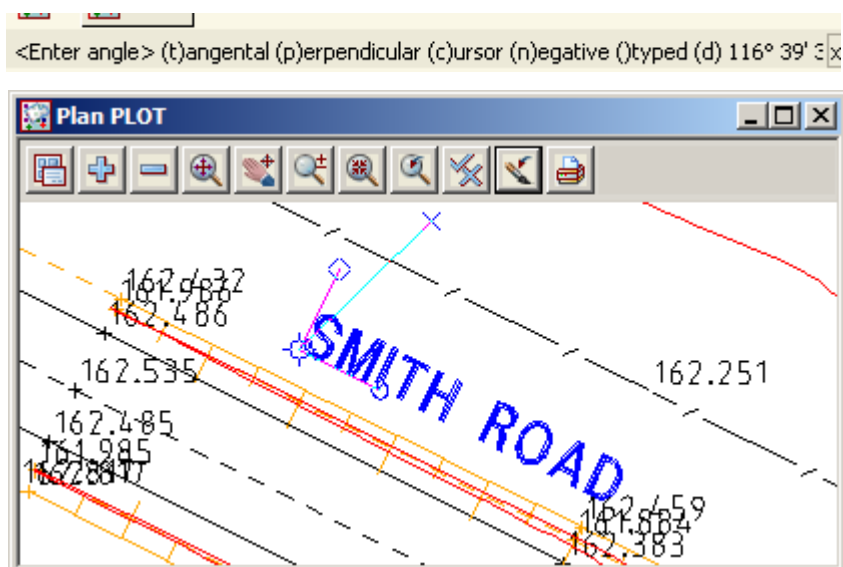

9.10.7 Grid display

A grid can be displayed and plotted with user defined attributes such as grid type, spacing, text placement and prefix / postfix additions to values

Select **Menu** icon then walk right on **Settings=>Grid**

The 'Grid on View' dialog box contains the following settings and annotations:

- view:** PLOT (Select view **PLOT**)
- grid draw:** (Tick the **grid draw** check box)
- Draw last on view:** (Select **grid mode** choice icon)
- grid mode:** full lines (Select **full lines**)
- grid x:** 50 (Type in the **grid x** (width) value)
- grid y:** 50 (Type in the **grid y** (height) value)
- grid level:** 0 (Select **grid colour**)
- grid colour:** dark green (Select **text x** choice icon)
- text x:** text at bottom (Select **text at bottom**)
- text y:** text at left (Select **text y** choice icon)
- text style:** ISO (Select **text at left**)
- Pre*postfix x:** E*m (Type in text to prefix/suffix the x values)
- Pre*postfix y:** N*m (Type in text to prefix/suffix the y values)
- text height (pix):** 5 (Type in **text height** in pixels)
- text plot height (mm):** 2 (Type in **text plot height** in mm)
- text colour:** dark green (Select **text colour**)
- cross size (pixels):** 5 (Type in **cross size** in pixels and mm)
- cross plot size (mm):** 1 (Type in **cross size** in pixels and mm)
- Grid set:** (Select **Set**)

The grid can be turned on and off using the **Toggle** icon then selecting **Grid**

The 'Plan PLOT' window shows a site plan with a grid overlay. A 'Toggle "PLOT"' menu is open, listing various display options:

- Culling [off]
- Linestyles [on]
- Sewer [n/a]
- Text [on]
- Vertices [n/a]
- Vertex indices [n/a]
- Z values [n/a]
- String names [n/a]
- Attributes [n/a]
- Arc centres [n/a]
- Tin contours [n/a]
- Tin edges [n/a]
- Tin flow [n/a]
- Tin solid [n/a]
- Grid [x]
- Rasters [n/a]
- Point id's [n/a]

9.10.8 Quick sheet plot

A section of the survey can be easily plotted without the need to set up a plot frame. There is a new improved Quick plot option called QUICK SHEET PLOT.

Zoom in to point 2722

Select **Print** icon then select **Quick sheet plot**

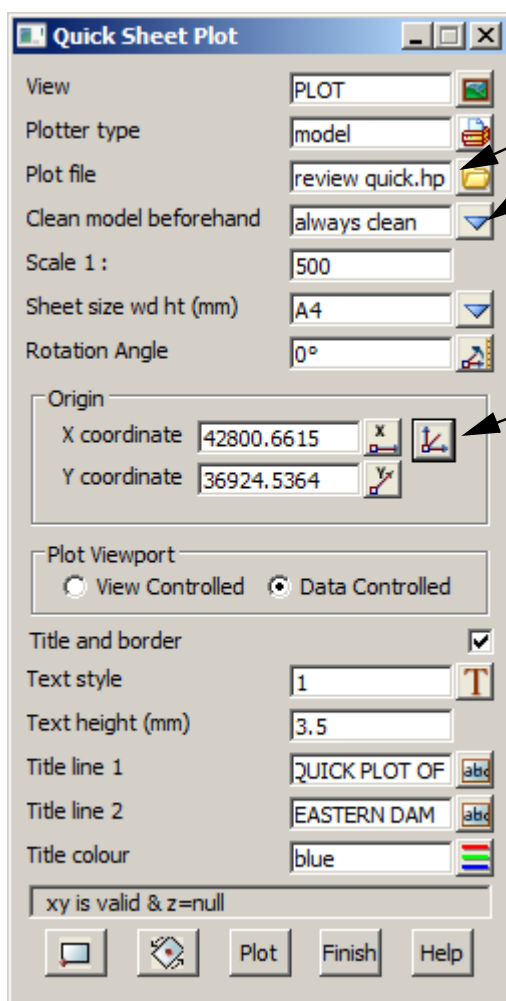
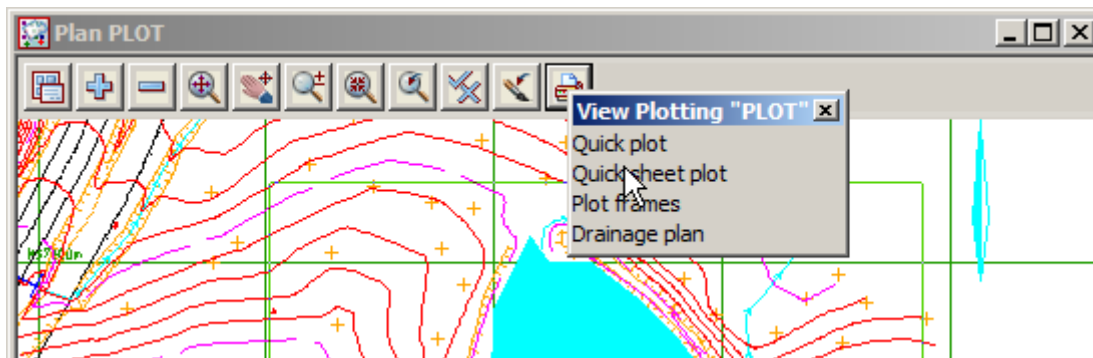

Fill in the panel as shown. Make sure that the plotter type is **model** so that we can preview the plot.

Type in **preview quick** for the model name

Select **always clean** as clean model mode

Select the location of the lower left corner of the plot sheet

There are two types of plotting methods. The first is **View Controlled**

Using this option the view can be zoomed in or out and the plot frame size stays linked to the view edge

Data controlled uses the parameters in the panel such as Scale and origin coordinates

We are using Data Controlled for the following plot

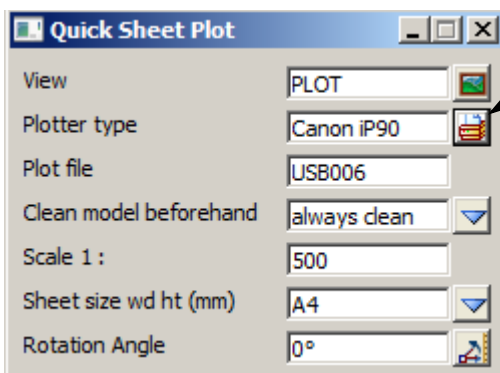
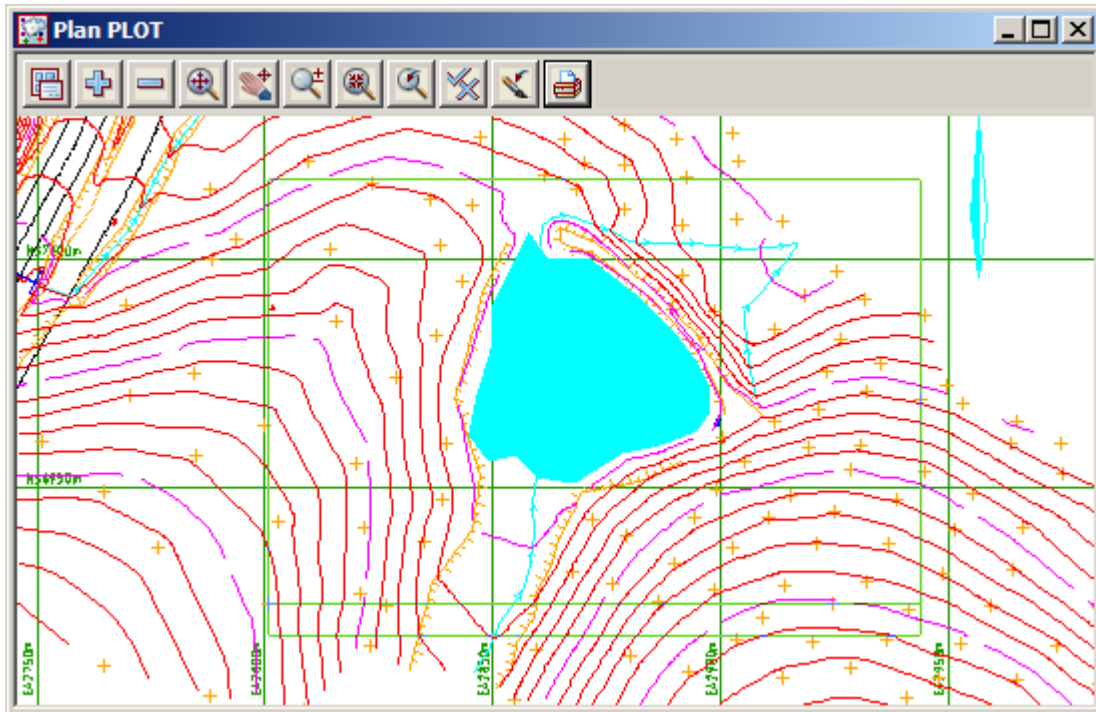

Once the model plot has been checked the plotter type can be changed for output to a printer

Once the printer has been configured select **[Plot]** to send the plot to the printer

9.10.9 Plotting Using Plot Frame

Create Plot Frame

User defined plot frames can be placed over the survey. These frames show both the sheet size and plot area borders.

Select option *Plot=>Plot frames=>Create*.

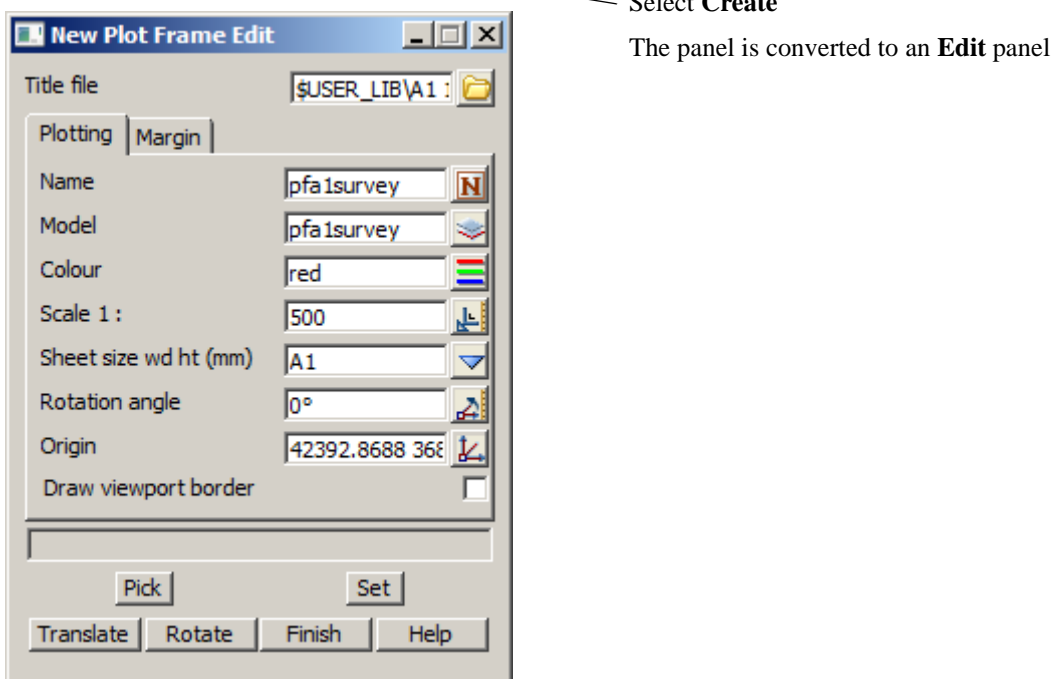
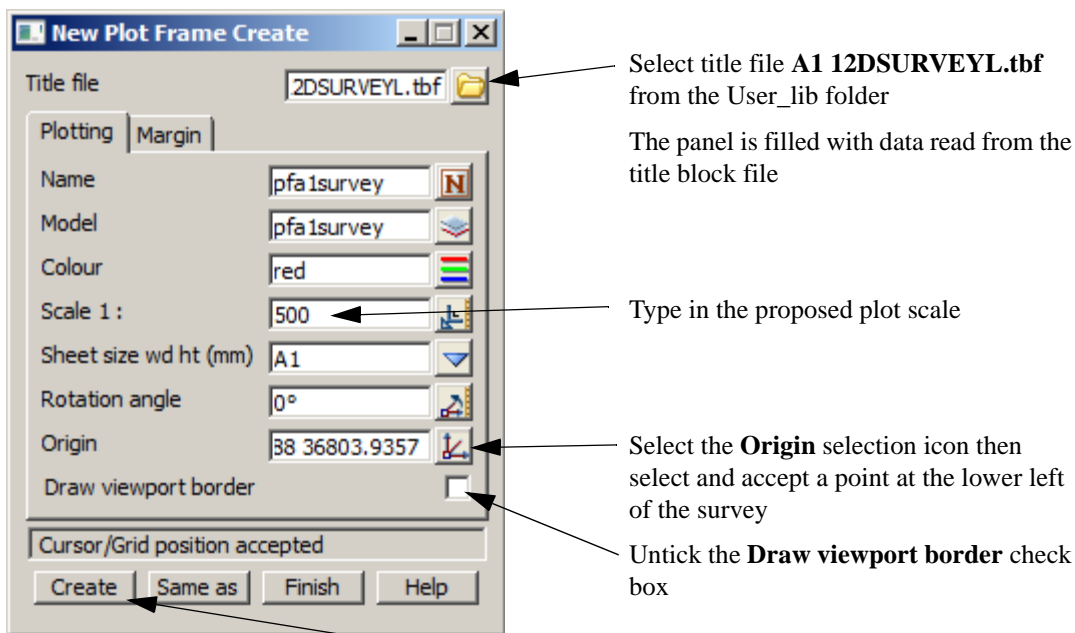

Turn on the model **pfa1survey**

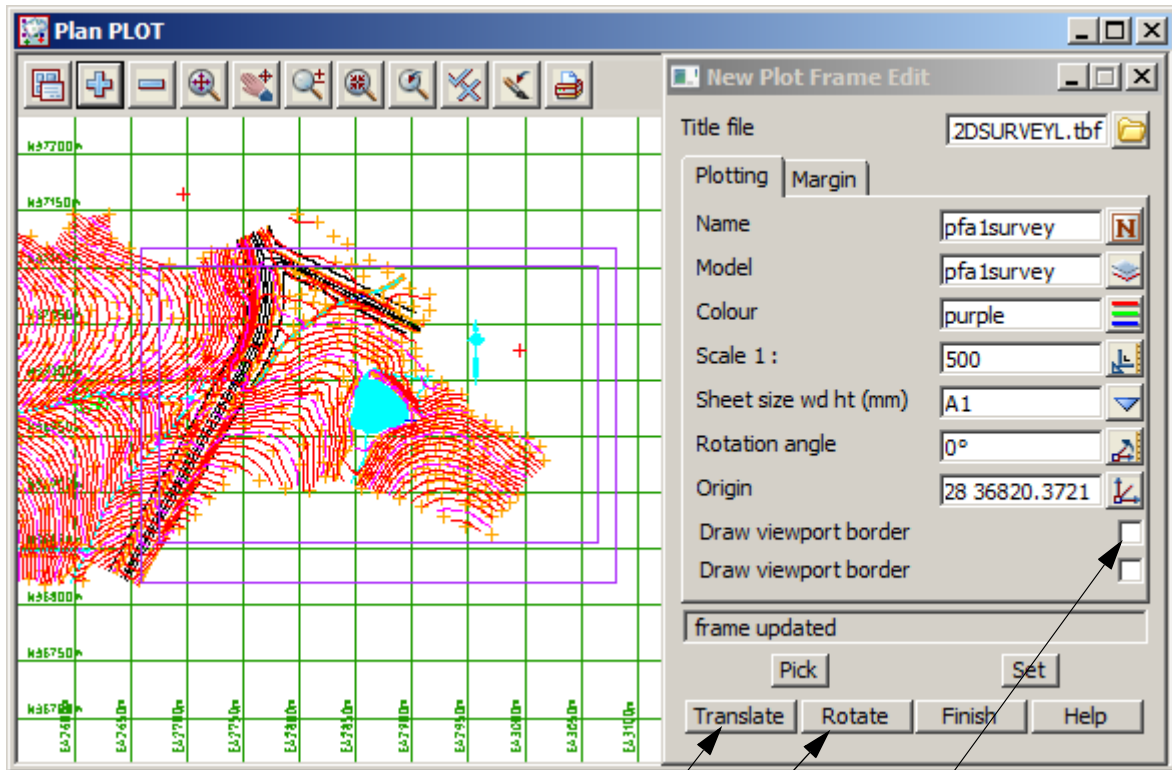

To move the plot frame over the survey select **Translate** and move the plot frame manually to the required position.

Select and accept that position

To rotate the plot frame type in a rotation angle or select **Rotate** and use the cursor to change the rotation. Select and accept the position.

Untick the **Draw viewport border** check box then select **Set** then **Finish**

Create Plot Using Plot frame PPF Editor

Select option *Plot=>Plot frames=>Plot* or select the plan view plotting icon



Select the option **Plot frames**

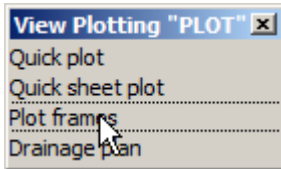

This brings up the **Plot frame PPF Editor** panel

The initial plot frame options appear.

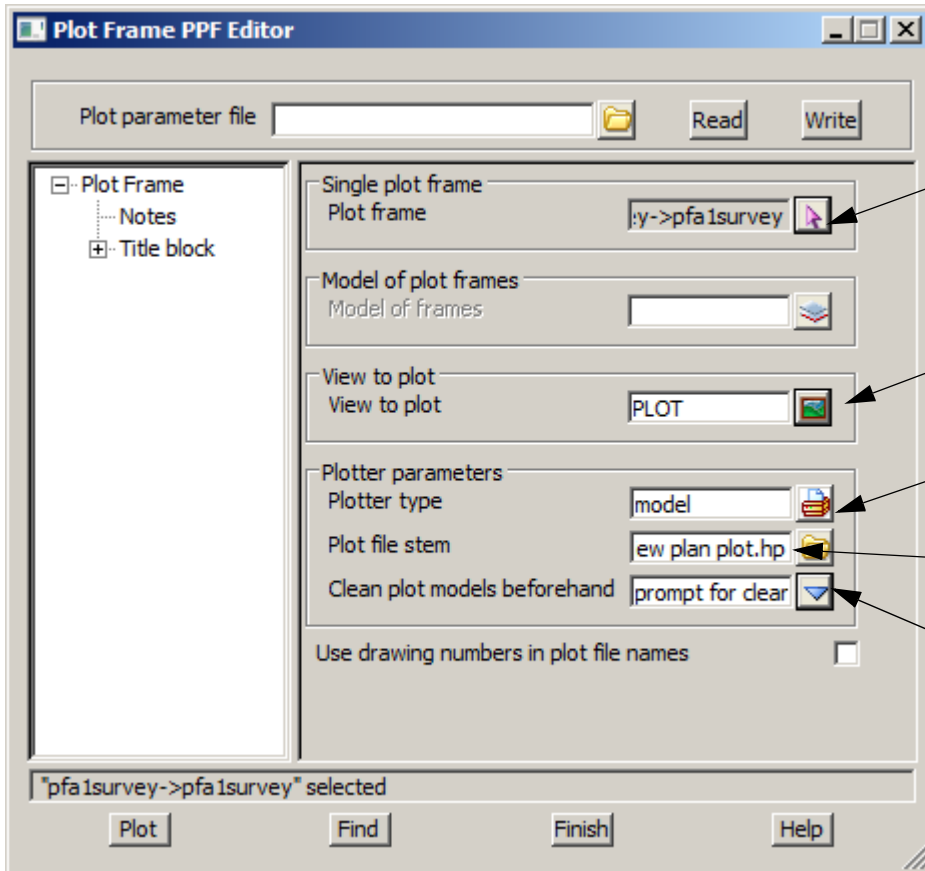

- Select **Plot frame** pick icon
- Select and accept a corner of the plot frame
- Select **View to plot** icon and select view **PLOT**
- Select **Plotter type** icon and select **model**
- Type in model name **preview plan plot**
- Select **Clean plot models** choice icon and select **prompt for clean**

Select **Notes** to enter notes about the plot parameter file

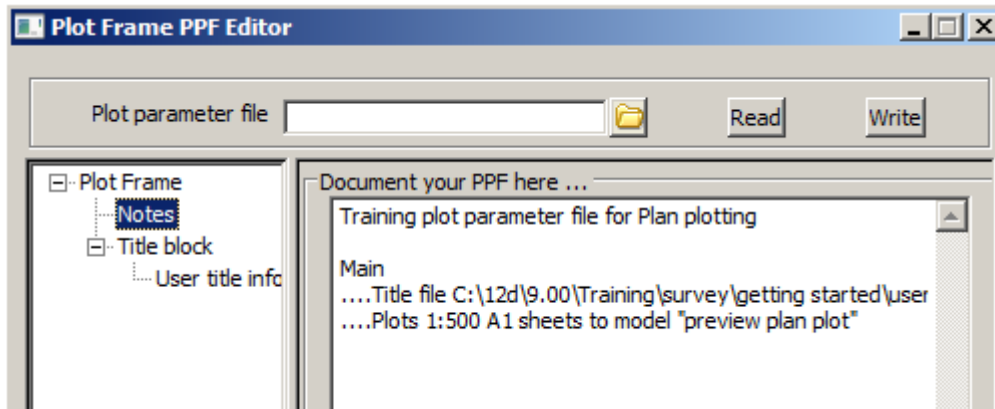

Type in notes to use as a guide if opening the same plot parameter file at a later stage

Select **Title block**

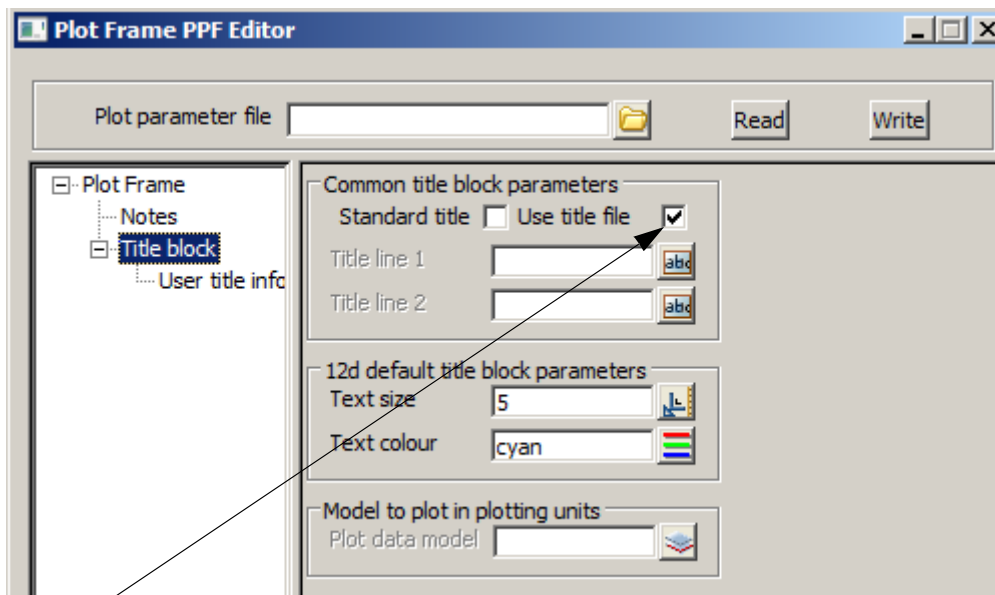

We are going to use a title file so we tick the **Use title file** check box

Select the [+] symbol to expand the next option

Select **User title info** to specify title file and title block text

Select **Title file** folder icon then double click on file **A1 12DSURVEYL.tbf** from the User_lib folder

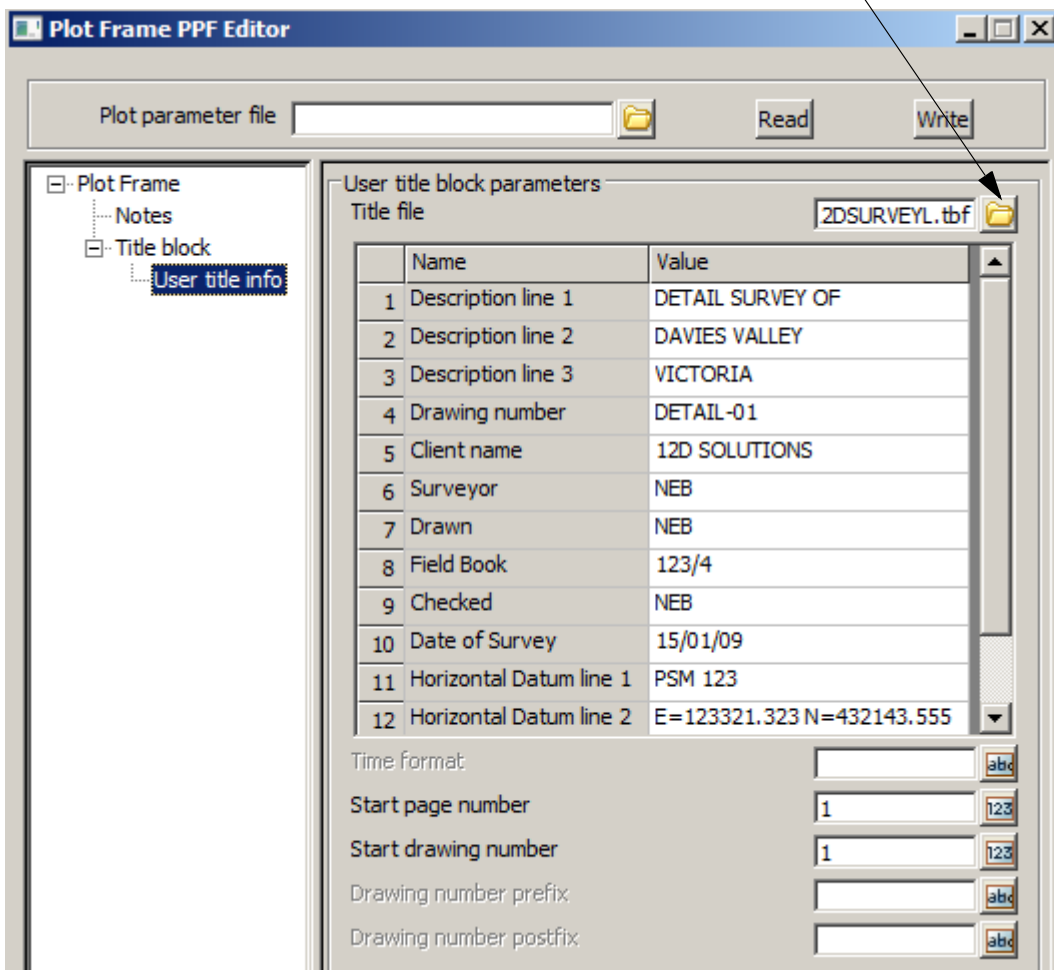

User defined prompts inserted into the title file are displayed here
 Fill in the values for each of the prompts

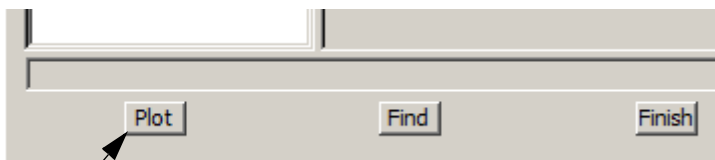

Select **Plot** to create a check plot in model **preview plan plot**.

DON'T PRESS FINISH YET

Display and check the plot

Move the panel to the bottom of the screen

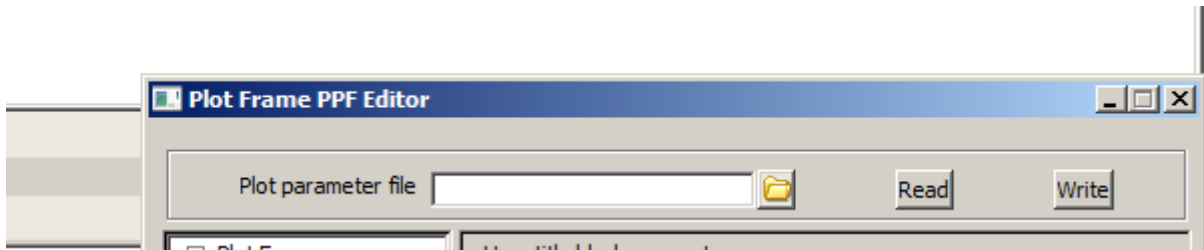

The plot has been created in the model called **preview plan plot1**

Create a new view called **PREVIEW**. This is done in the same way that we created the plan view PLOT.

In the view **PREVIEW** turn on model **preview plan plot1**

The preview can be checked for errors prior to plotting to the plotter.

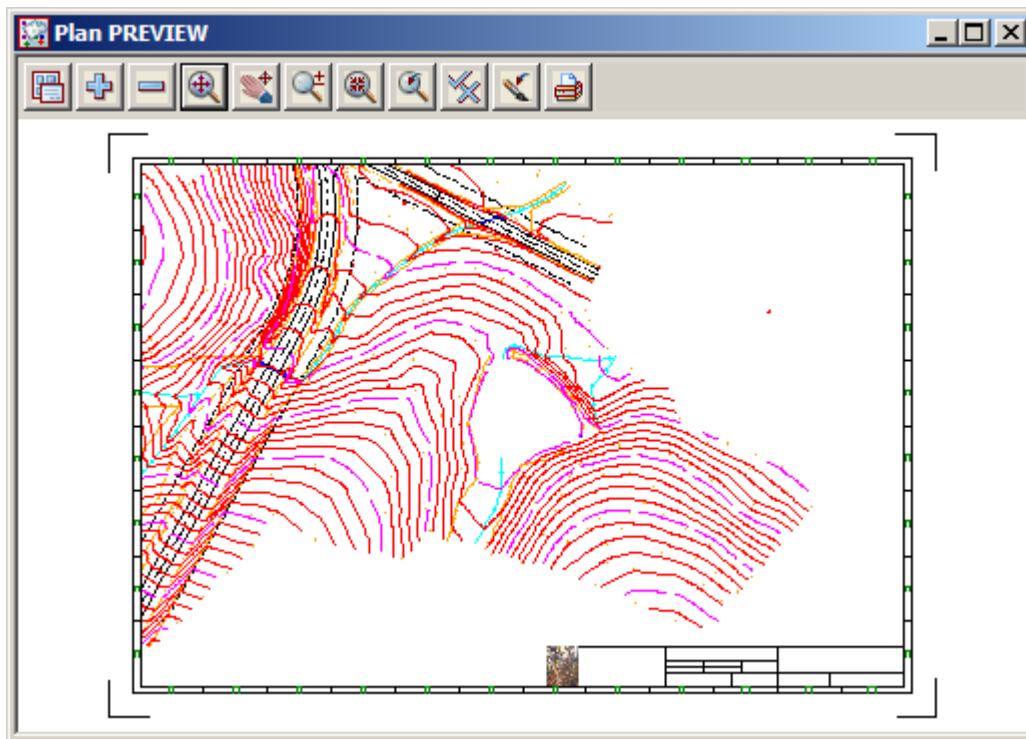

Once the preview model has been checked, bring up the **Plot Frame PPF Editor** panel and select Plot Frame

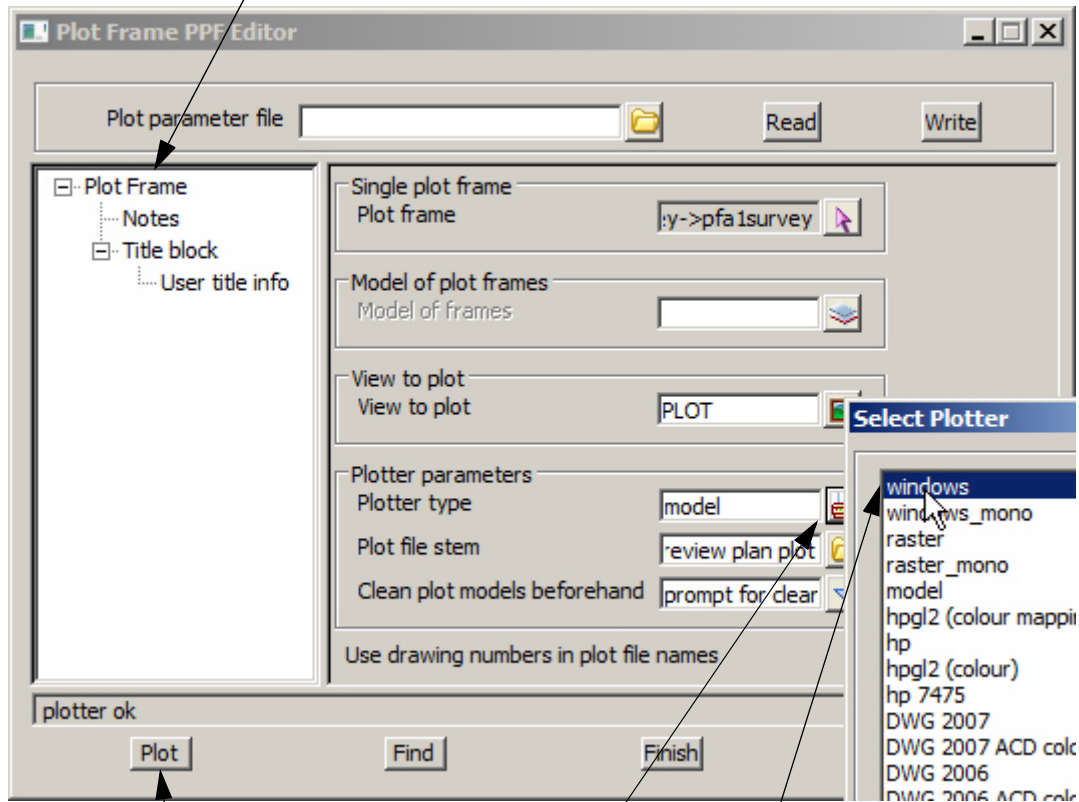

Select the **Plotter type** icon
 Select the required plot device as shown previously
 Select **Plot** to send the plot to the selected device

Finally, to save the plot settings for any future plotting, type in a name for the plot settings
 Type in **PLAN PLOT**

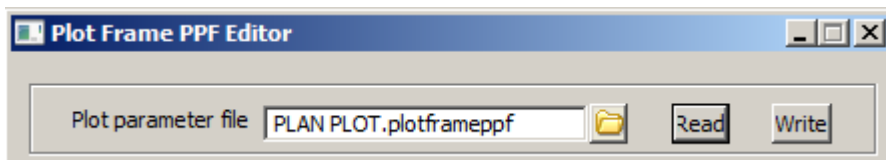

When pressing **Enter** the file is given the extension ".plotframeppf". Select **Write**
 This file can be called up in future when using the **Plot Frame PPF Editor** option



10 Volumes

In this chapter we will look at various types of volume calculations including:

Stockpile volumes

Dam Capacity

Surface comparisons

Progressive quarry volumes

10.1 Stockpile volume

This topic deals with calculating the volume of a stockpile given data for both the existing surface prior to the stockpiles creation and the surface of the stockpile

A volume will be calculated between the triangulations (tin) of the two surfaces

To begin create a new project called **STOCKPILE** in the Survey training area

First, double click on the *12d Model 9* icon to bring up the **Project Selection** panel.

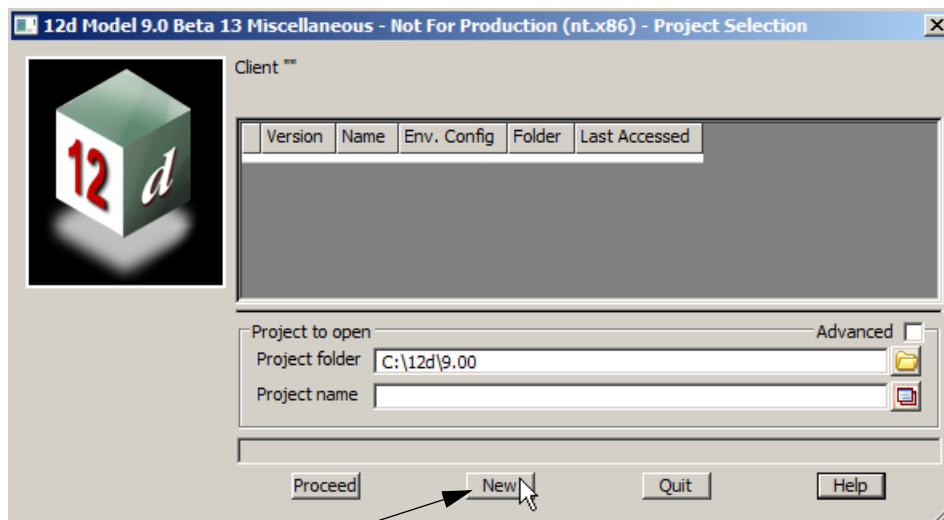
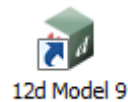

Select **New** button to bring up the **New project** panel.

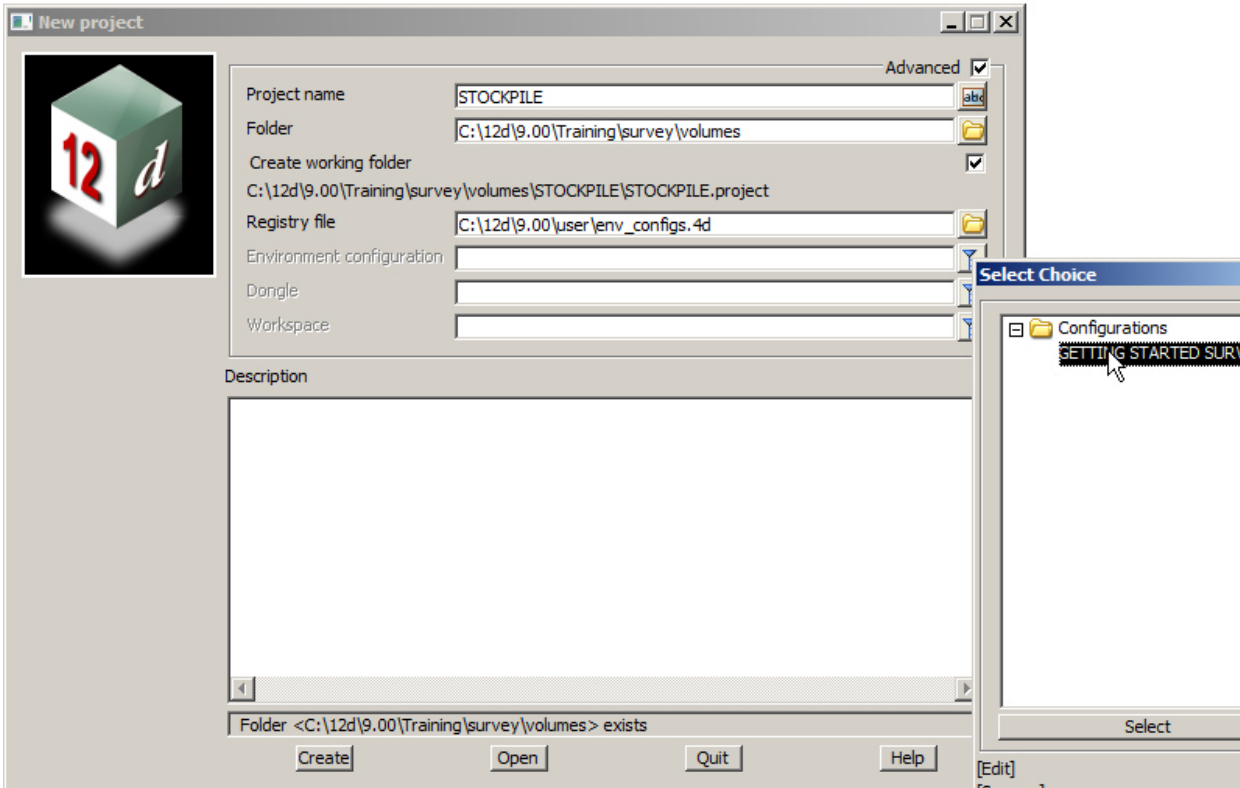

Create a project under the folder **C:\12d\9.00\Training\survey\volumes** called **STOCKPILE**

With the *Create working folder* check box ticked a working folder with the same name as the project will be also created

Select the Environment configuration **Configurations=>GETTING STARTED SURVEY** which is the one we set up in the previous chapters. If you have gone straight to this chapter you will have to follow the steps in chapter 9.2 to edit the Registry file

Select [**Create**] to create and open the project

Screen Setup

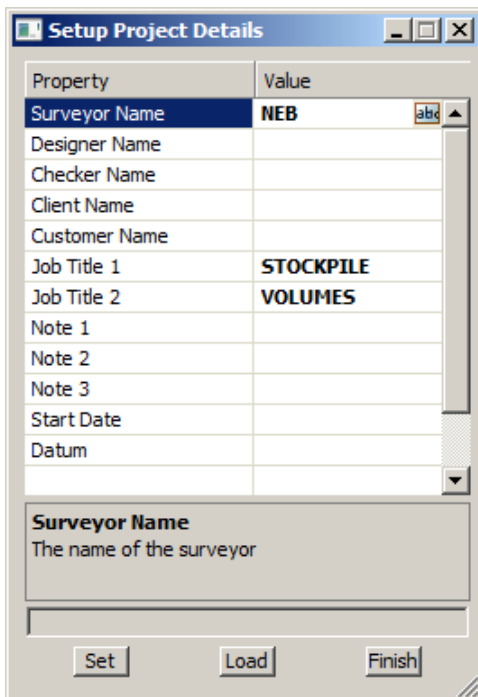

When the project starts up for the first time the **Project Details** panel appears

The information typed in here can be used when plotting from this project

Fill in the various prompts if necessary

Select **Set** then **Finish** to save the settings and continue

10.1.1 Existing surface

We will read in the data for the existing surface. The data is in the form of a 12d ascii file

Read in data

Select option *File I/O=>Data Input=>12da/4da data*

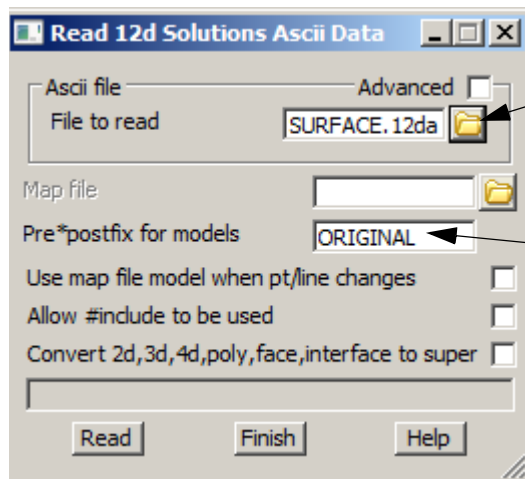

Browse up one level to the folder
C:\12d\9.00\Training\survey\volumes
 and select the file **STOCKPILE EXISTING SURFACE.12da**

Type in **ORIGINAL** for model prefix
 This will help separate data from multiple files

Select **Read**

The survey points in model ORIGINAL TOPO SURFACE LEVEL appear

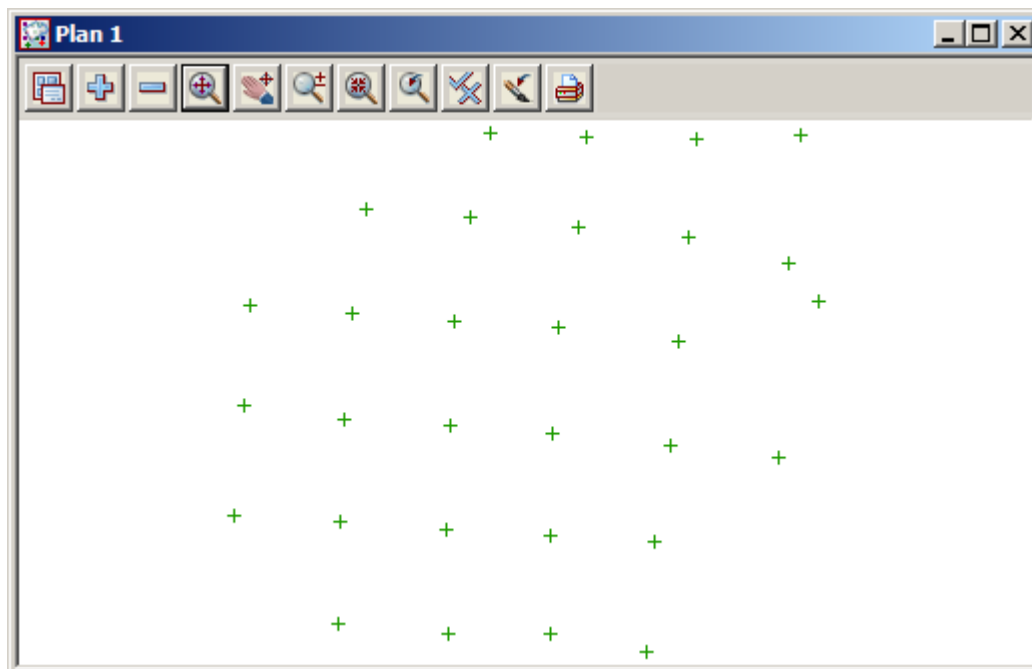

Triangulate the existing surface

We now form a tin using the points from the original surface.

Select **Tins=>Create=>Triangulate data**

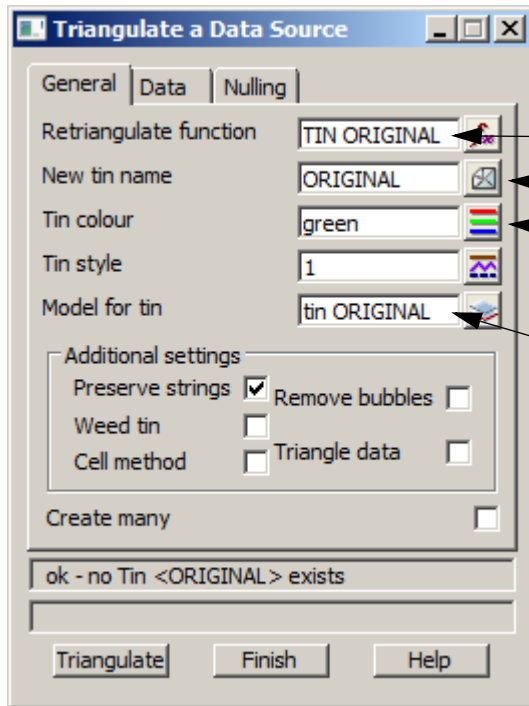

Type in the function name **TIN ORIGINAL**

Type in the tin name **ORIGINAL [Enter]**

Select colour **green** for tin

When selecting **[Enter]** key after entering tin name the model name is automatically created with **tin** as the prefix

The only check box needed to be ticked is **Preserve strings** which will ensure breaklines are inserted at the time of triangulation

Select the **Data** tab

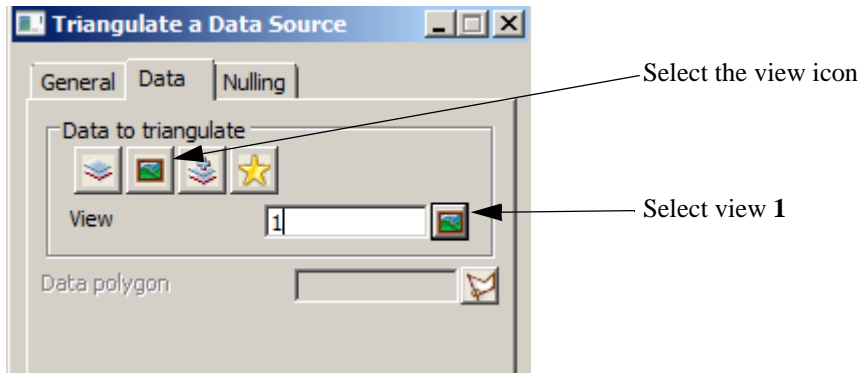

Select the **Nulling** tab

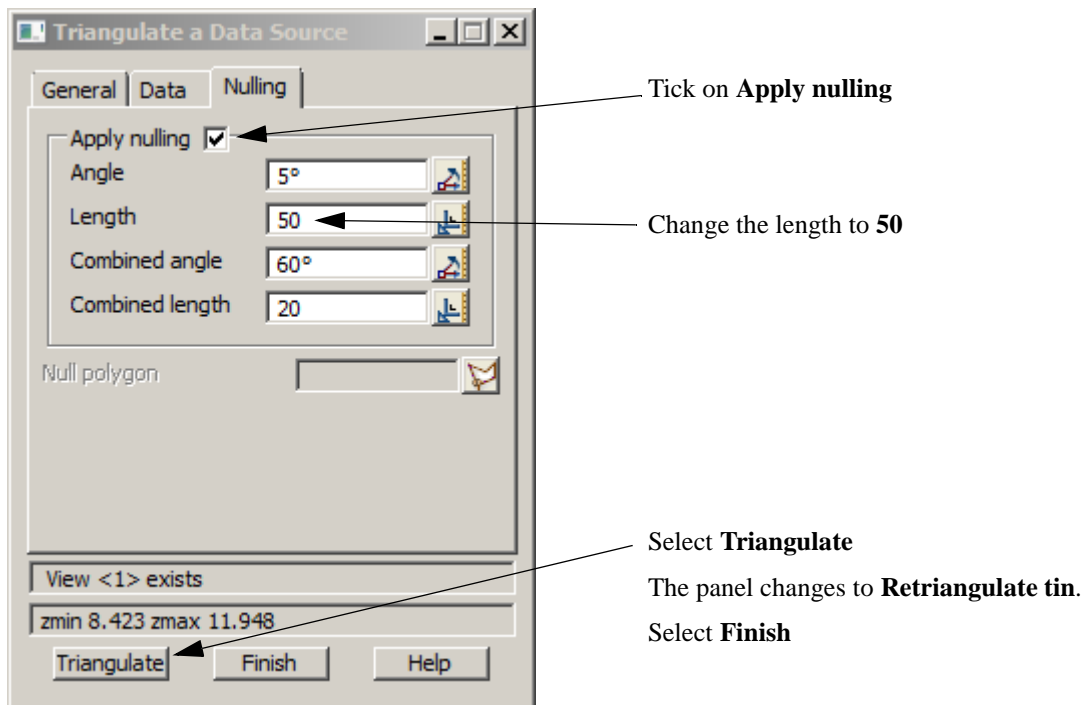

Turn on the model **tin ORIGINAL** to view the triangulation

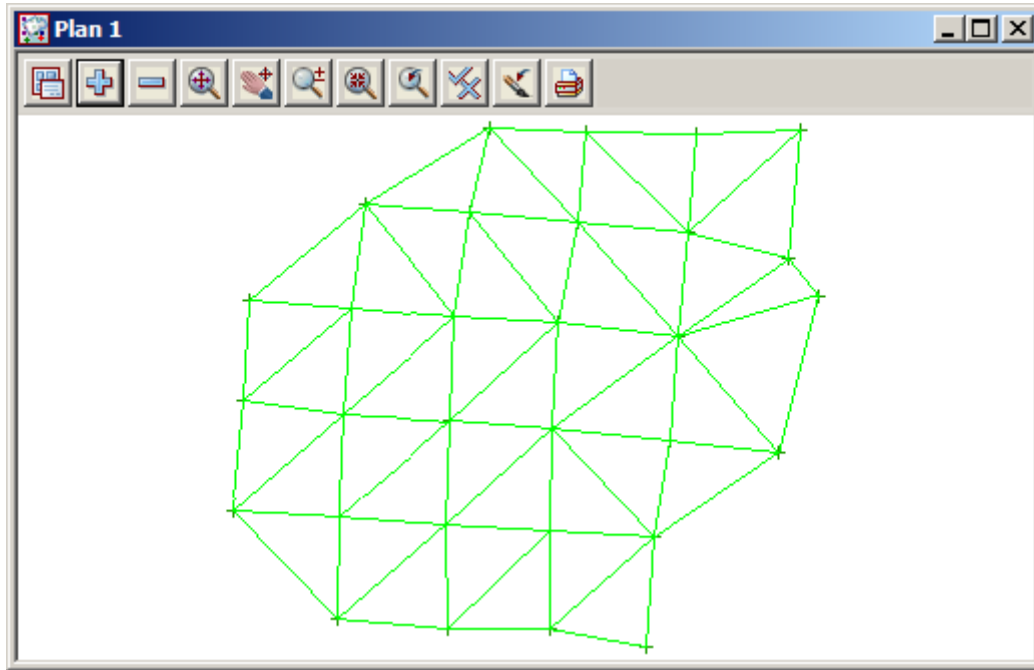

Toggle on the contours

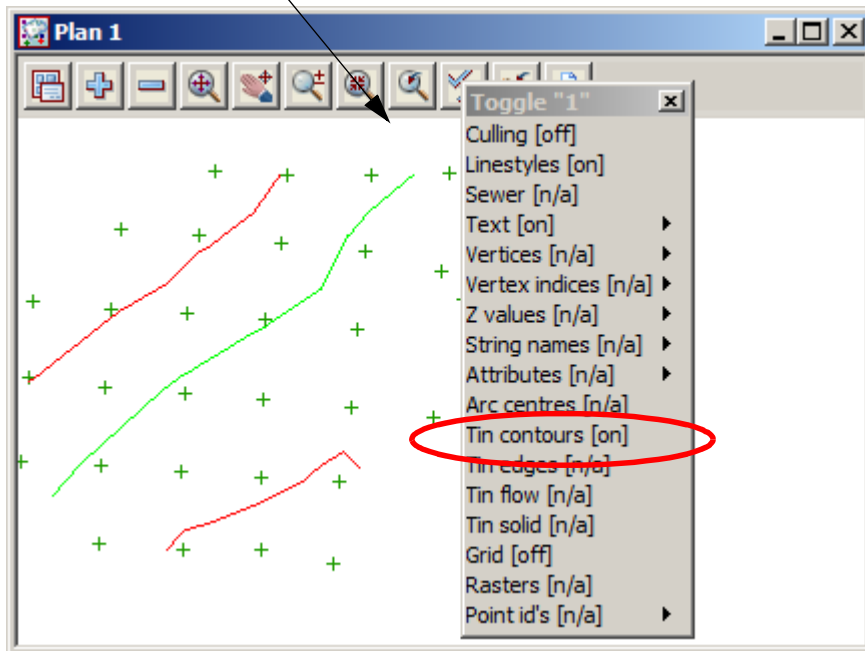

10.1.2 Stockpile surface

We will now read in the data for the stockpile surface. The data is again in the form of a 12d ascii file but this file also includes the tin of the stockpile surface

Firstly turn off all existing models

Read in data

Select option *File I/O=>Data Input=>12da/4da data*

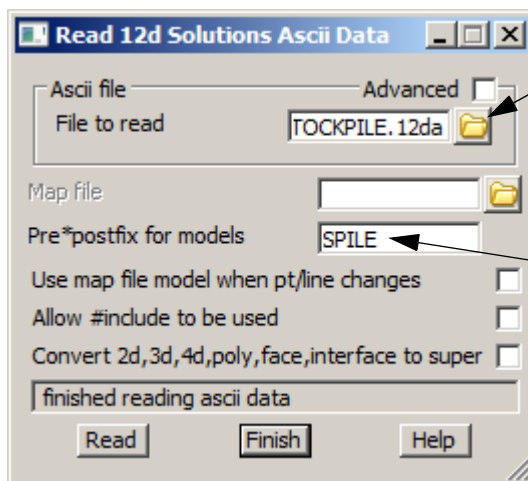

Browse up one level to the folder
C:\12d\9.00\Training\survey\volumes
and select the file **STOCKPILE.12da**

Type in "**SPILE** " for model prefix

Select **Read**

The survey points of the stockpile will appear along with the tin. The contours are displayed

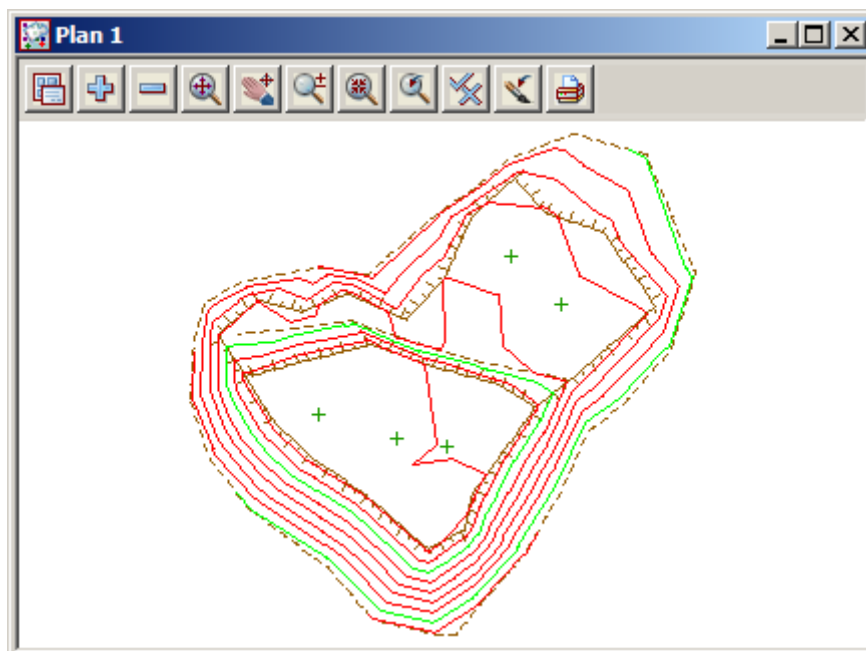

The only issue with importing tins inside ascii files is that if the you tried to retriangulate the tin it will not work as the model names have changed due to the prefixing. Also the tin function name is not held in the 12d ascii file. So remember not to retin the data.

Also the tin model shouldn't really have a prefix as it is preferable to keep them all in the same area in the model list.

We can rename the tin model using the option *Models=>Rename*

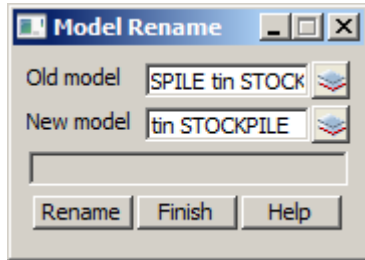

Select the model **SPILE tin STOCKPILE**
and rename to **tin STOCKPILE**

10.1.3 Check stockpile tin lies within existing tin

We will now turn on both triangle models to check that the stockpile tin sits inside the tin created from the existing surface points.

If this is not the case then the volume calculation will only cover the area where the two tins coincide.

Turn on model **tin ORIGINAL**
Toggle off the contours.
Ensure the outline of the stockpile triangulation lies completely inside the original surface triangulation

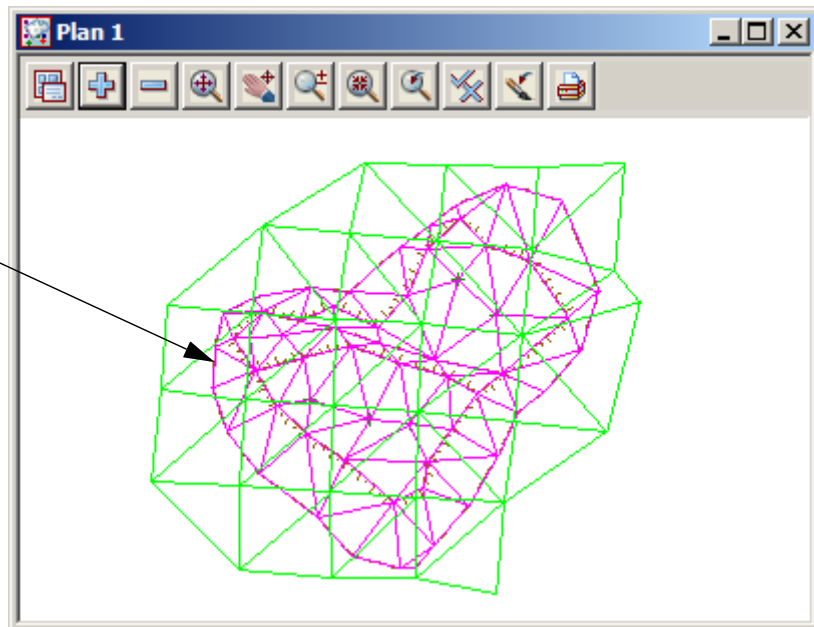

10.1.4 Calculate volumes by exact method

The volume between the two tins can now be calculated and written to a report file

Select *Design=>Volumes=>Exact=>Tin to tin*

Select **ORIGINAL** for original tin model

Select **STOCKPILE** for new tin model

Type in **STOCKPILE VOLS** for report file name

NOTE - report files are not available in the 12d Model Practise Version

Select **Polygon** choice icon

Select **String pick** icon then pick and accept the string around the edge of the stockpile

Select **Volume** to calculate the volume between the two surfaces

The volumes of cut and fill are displayed at the bottom of the panel

The report is activated in the default text editor (*Notepad* is the default)

The two surfaces used are listed in the report header

The volume of cut is listed along with the fill volume and the balance (Fill - Cut)

The polygon plan area is the horizontal area of the outline of the stockpile

```

STOCKPILE VOLS.rpt - Notepad
File Edit Format View Help
Project: STOCKPILE
User: Noel
Organization: 12d Training - Qld
Report File: STOCKPILE VOLS.rpt

Volumes from tin "ORIGINAL" to tin "STOCKPILE" - (with plan po
cut volumes are negative
fill volumes are positive

Total cut -0.041
Total fill 17573.394
Total balance 17573.353
ie excess of fill over cut 17573.353

Polygon plan area = 4325.174
    
```

Exit the text editor and select **Finish** on the Volume panel

10.1.5 Calculate volumes by End area

Another type of volume calculation is the end area method. Volumes are calculated between cross sections generated through the stockpile. An alignment is not necessary to produce the sections.

Strings will be created at each cross section for viewing in the section view

It important to note that the smaller the separation of the sections the more accurate the volume

Select option *Design=>Volumes=>End area=>Tin to tin*

Annotations for the 'End Area Volume Between Tins' dialog:

- Select **ORIGINAL** for original tin name
- Select **STOCKPILE** for new tin name
- Type in the angle **135** for the cross sections
- Typed in **10** for the distance between sections
- Type in **xs original** as existing section model name
- Type in **xs stockpile** as stockpile section model name
- Tick check box to clean section models
- Select the **Poly** icon. Select the **String pick** icon then pick and accept the string around the edge of the stockpile
- Select **Report mode** icon then pick **STOCKPILE VOLS.rpt**
- Select **Summary**
- Select **Volume mode** choice icon then select **Average end area**

Select **Volume**

Select **Append** to append the volume results to the end of the previous report

NOTE - report files are not available in the 12d Model Practise Version

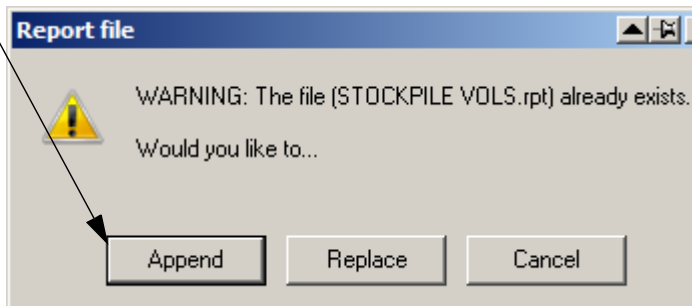

As per the previous option the report is displayed

The original report is amended with the volume by end area placed at the end of the report

The distance between the sections is displayed

The direction of the section strings is displayed

The polygon plan area is the horizontal area of the outline of the stockpile

The volume of cut, fill and balance is listed

```

STOCKPILE VOLS.rpt - Notepad
File Edit Format View Help

Project:      STOCKPILE
User:         Noel
Organization: 12d Training - Qld
Report File:  STOCKPILE VOLS.rpt

Volumes from tin "ORIGINAL" to tin "STOCKPILE" - (with plan
cut volumes are negative
fill volumes are positive

Total cut           -0.041
Total fill          17573.394
Total balance       17573.353
ie excess of fill over cut  17573.353

Polygon plan area = 4325.174

Project:      STOCKPILE
User:         Noel
Organization: 12d Training - Qld
Report File:  STOCKPILE VOLS.rpt

----- BEGIN TIN-TIN VOLUME REPORT -----
surface to surface volume report - (with plan polygon "SPI
original tin ORIGINAL
new tin      STOCKPILE
separation   10.000
angle        135°00'00"
method       Average end area
extrapolated no

cut volumes and areas are negative
fill volumes and areas are positive

total plan area           4325.174
total cut                 -0.061
total fill                17351.899
balance                  17351.838
ie excess of fill over cut  17351.838

----- END TIN-TIN VOLUME REPORT -----

```

Turn on the cross section model **xs stockpile** and turn off the tins

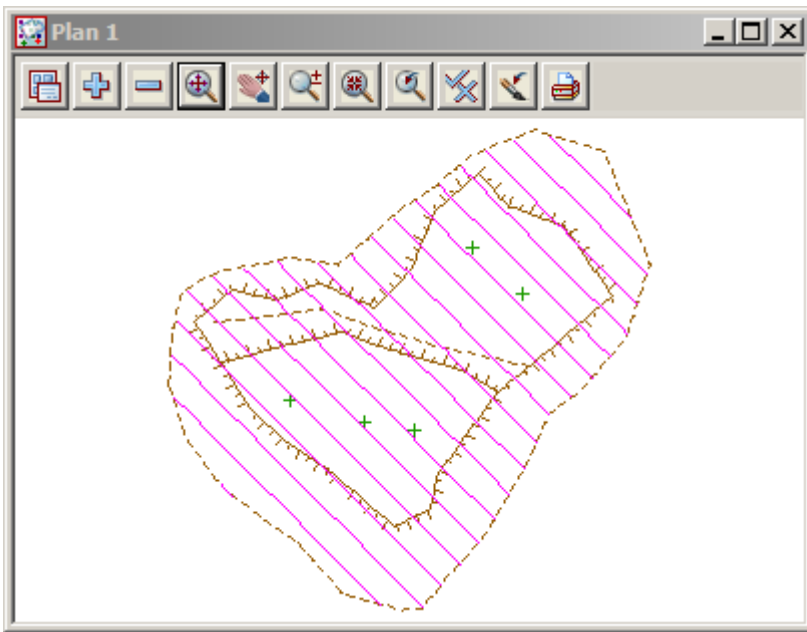

View stockpile sections

The cross sections can be viewed in a section view

To create a new section view select **View=>New=>Section**

To place the section view beside the plan view select **Window=>Tile Vertical**

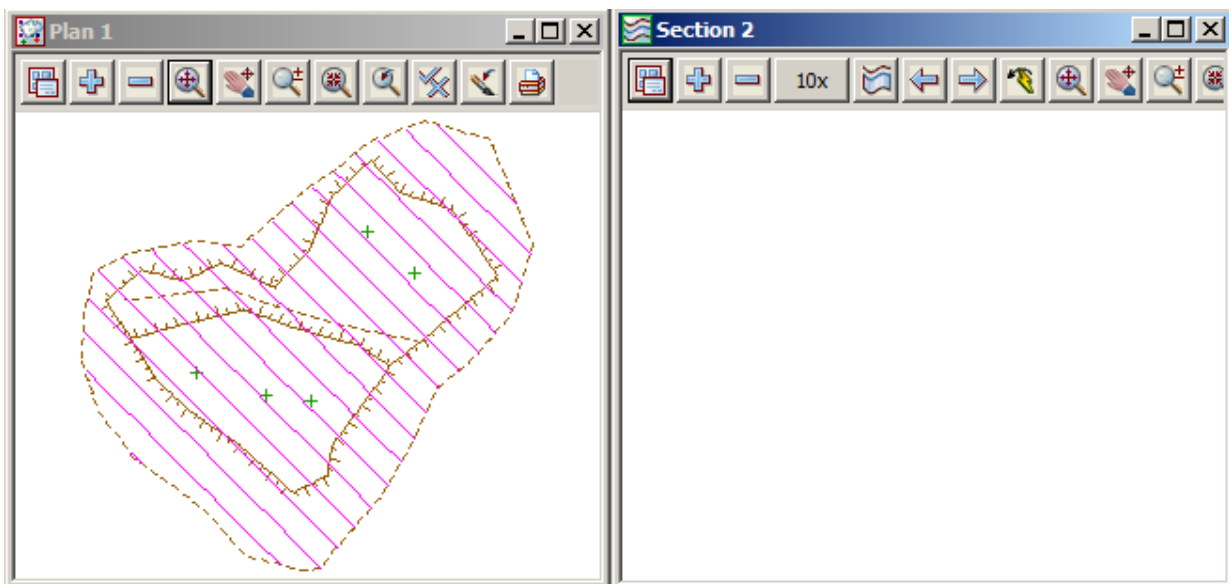

Turn on the two tin models in the section view

To view the cross sections select the profile icon  then pick and accept one of the section strings

To move along the sections use the **Prev** and **Next** icons

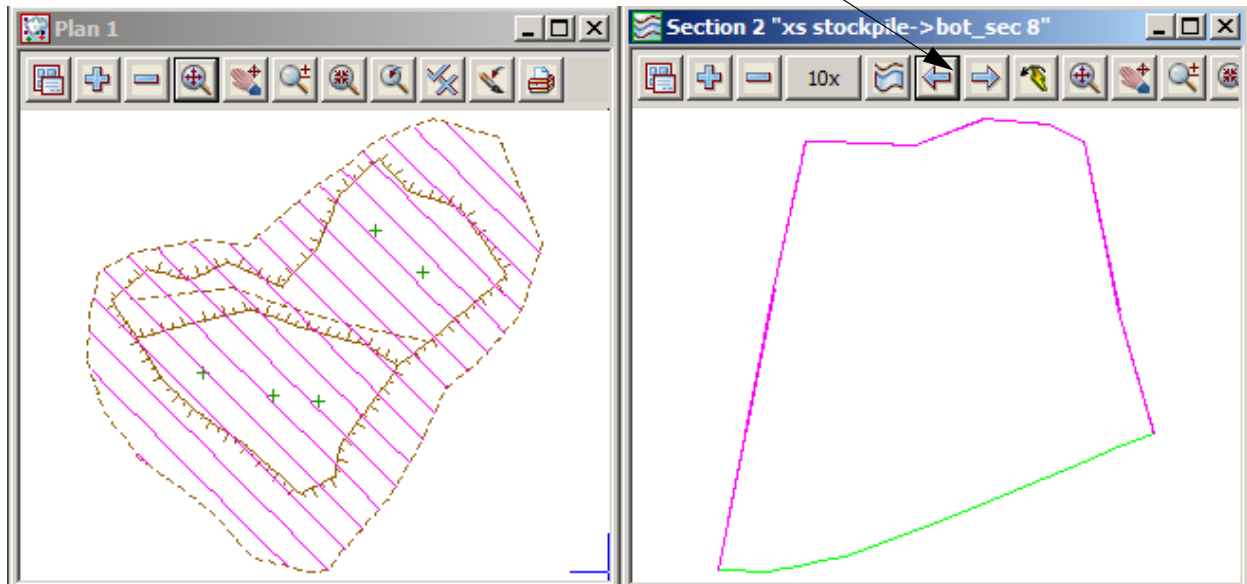

10.2 Multiple stockpiles

In this example multiple stockpile volumes can be calculated with one option. This macro will automatically create all necessary tins of the bases and tops of the stockpiles.

A Volume report will be created for each stockpile and volume text will be placed over each pile

Create a new project as shown previously called **MULTIPLE STOCKPILES** in the folder

C:\12d\9.00\Training\Survey\Volumes\MULTIPLE STOCKPILES

Remember to select the configuration GETTING STARTED SURVEY

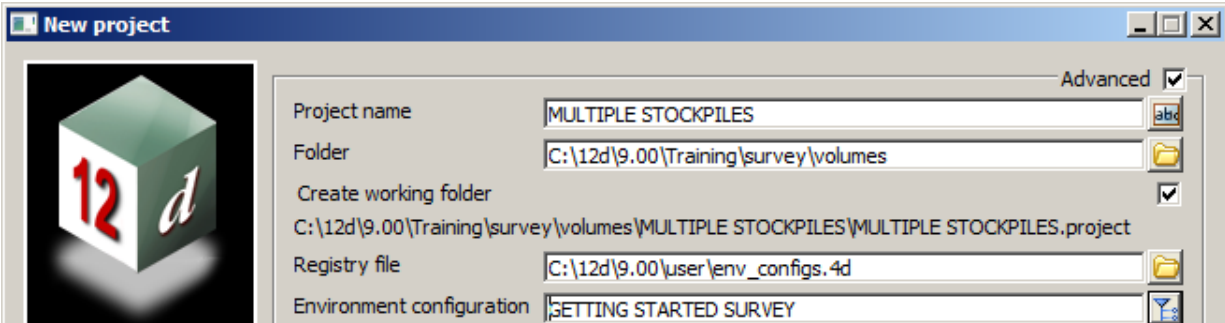

10.2.1 Read in Stockpile surface data

The surface data is in the form of a 12d ascii file

Select *File I/O=>Data Input=>12da/4da data*

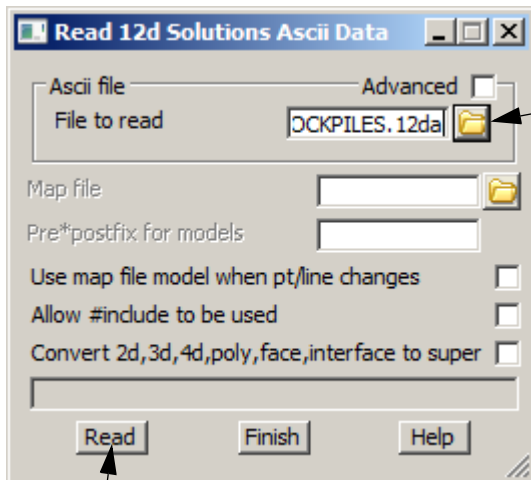

Select Ascii file icon

Browse to the folder

C:\12d\9.00\Training\survey\volumes

and select **MULTIPLE STOCKPILES.12da**

Select **Read** then **Finish**

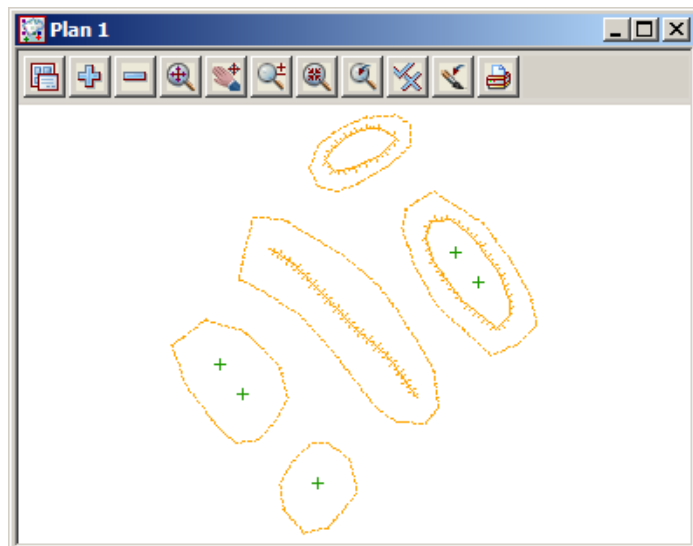

10.2.2 Run Stockpile macro

For this program to work, the strings around the bases of the stockpiles **MUST** share a unique code. This code should not be used within the stockpile as it is used to determine the extent of each pile.

Select option *Design=>Volumes=>Stockpile*

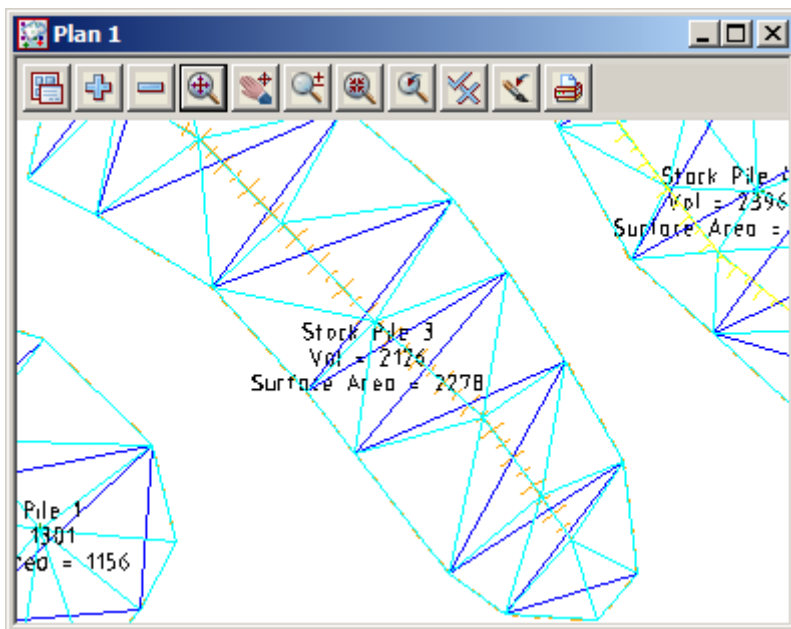

To read the volume report select the report file icon then select **Open**

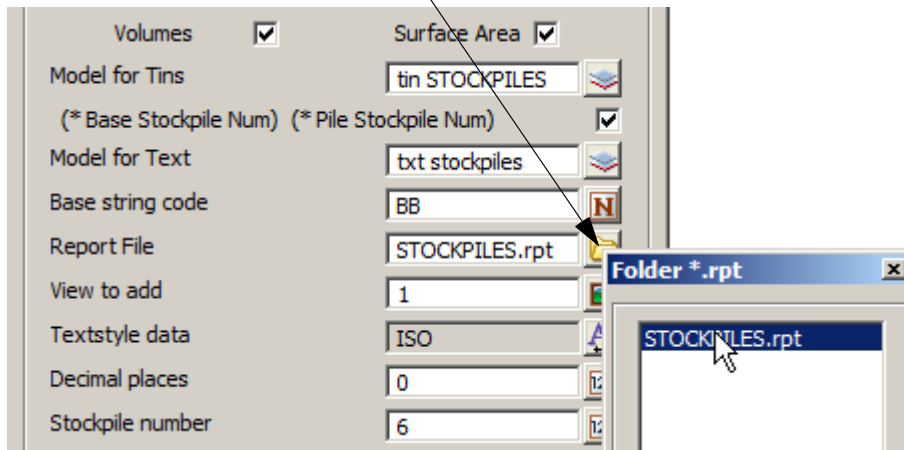

NOTE - report files are not available in the 12d Model Practise Version

```
0 10 20 30 40 50 60 70 80
1 Project: ..... MULTIPLE STOCKPILES
2 Date: ..... Tue Apr 21 12:56:14 2009
3 Report File: STOCKPILES.rpt
4 -
5 -----
6 Stockpile 1
7 -----
8 Total fill ..... 1301
9 Stockpile plan area = 1132
10 Stockpile surface area 1156
11 -
12 -----
13 -
14 -----
15 Stockpile 2
16 -----
17 Total fill ..... 701
18 Stockpile plan area = 612
19 Stockpile surface area 631
20 -
21 -----
22 -
23 -----
24 Stockpile 3
25 -----
26 Total fill ..... 2126
27 Stockpile plan area = 2246
28 Stockpile surface area 2278
29 -
30 -----
31 -
32 -----
33 Stockpile 4
34 -----
35 Total fill ..... 2396
36 Stockpile plan area = 1542
37 Stockpile surface area 1587
38 -
39 -----
40 -
41 -----
42 Stockpile 5
43 -----
44 Total fill ..... 563
45 Stockpile plan area = 631
46 Stockpile surface area 646
47 -----
48
```

After the final stockpile volume has been reported select **Finish** on the volumes report panel

Turn off all of the Stockpile base models and then toggle on the contours

To move the volume text outside each stockpile select option *Drafting=>Multi string translate*

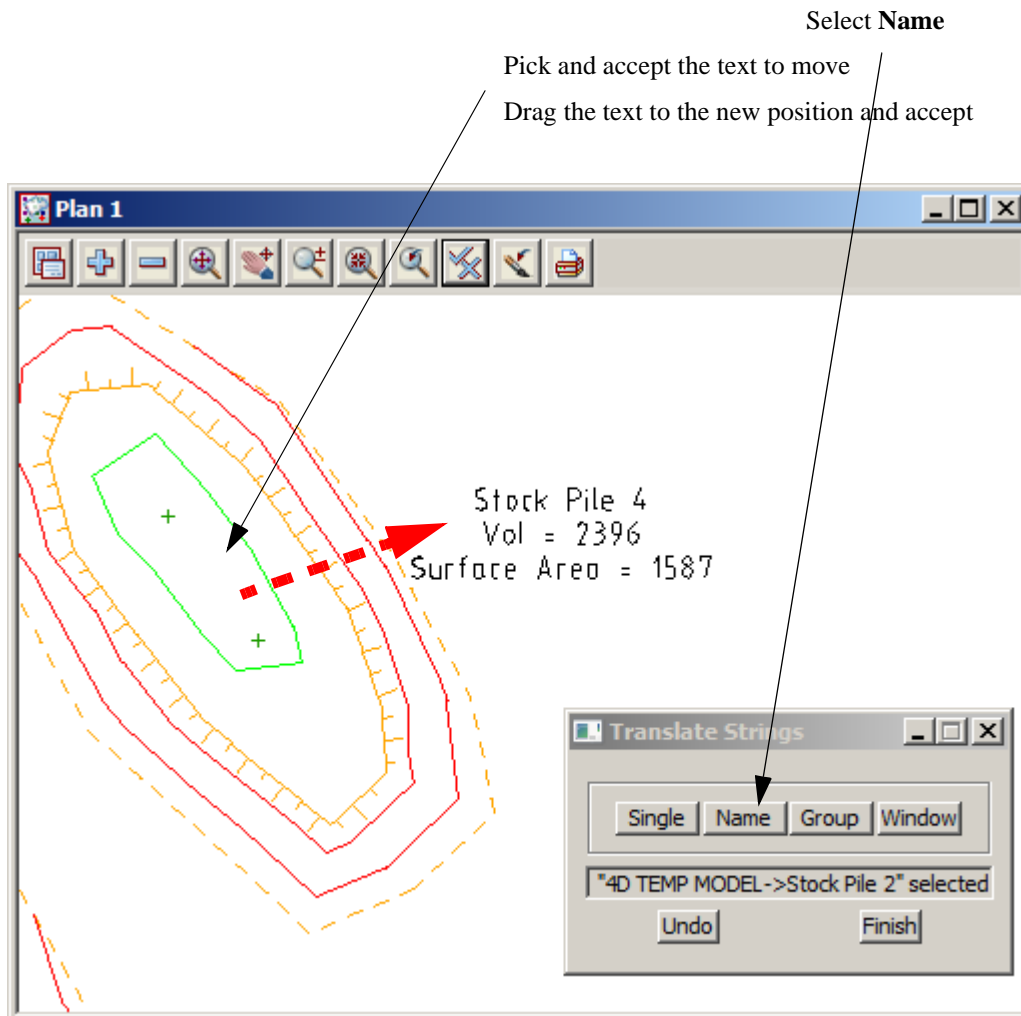

Select **Name** before moving each block of text

10.3 Dam Capacity

In this example the storage capacity of a dam will be calculated

Create a new project as shown previously called **DAM VOLUMES** in the folder

C:\12d\9.00\Training\Survey\Volumes\DAM VOLUMES

Remember to select the configuration **GETTING STARTED SURVEY**

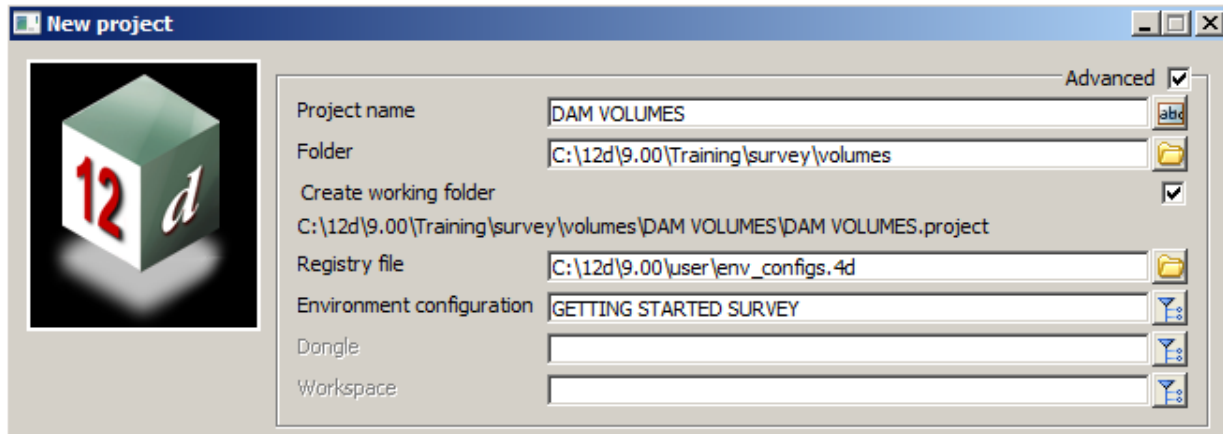

10.3.1 Read in Dam surface data

The surface data is in the form of a 12d ascii file

Select **File I/O=>Data Input=>12da/4da data**

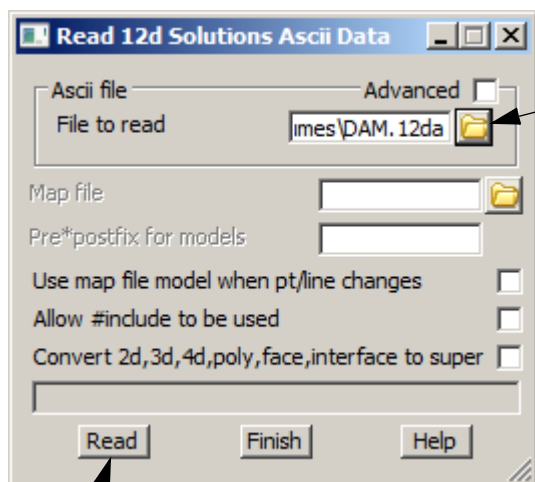

Select the **Ascii file** icon

Browse to the folder

C:\12d\9.00\Training\survey\volumes

and select **DAM VOLUMES.12da**

Select **Read** then **Finish**

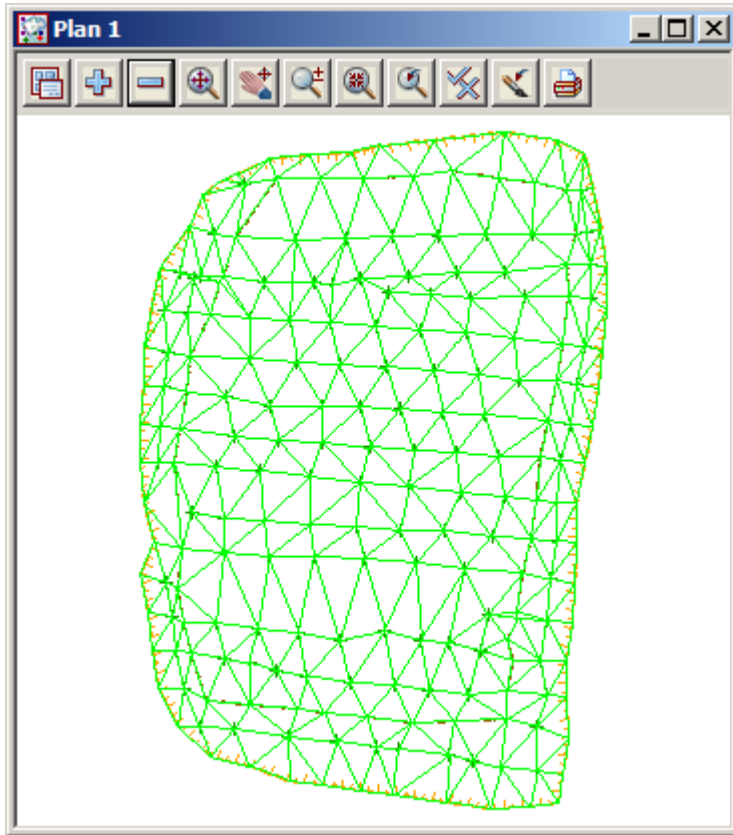

Turn on the contours

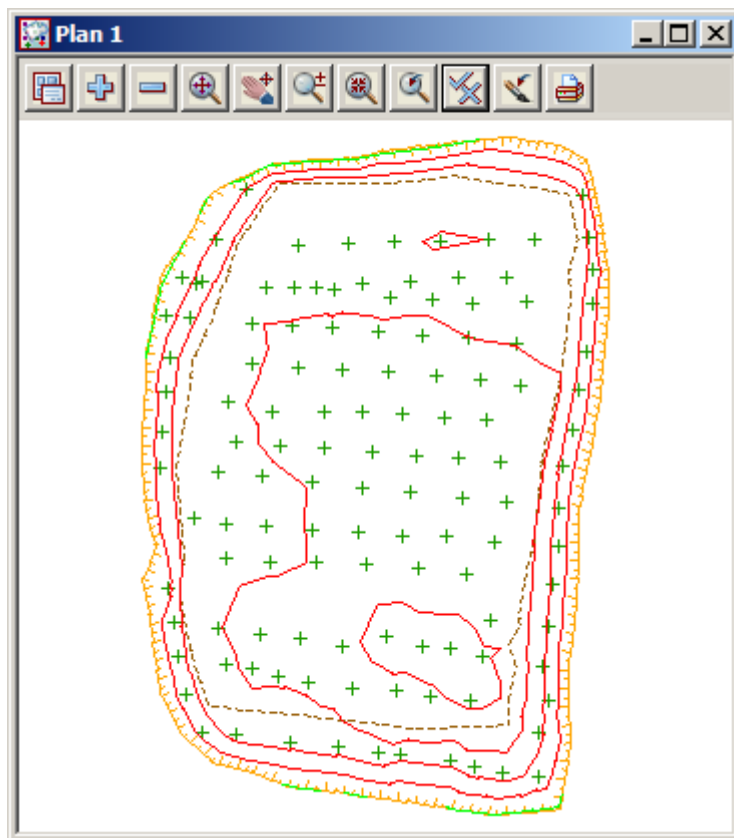

10.3.2 Calculate volumes by Storage Calcs method

The volume from the dam bottom surface up to a height can now be calculated

Select *Design=>Volumes=>Exact=>Storage Calcs*

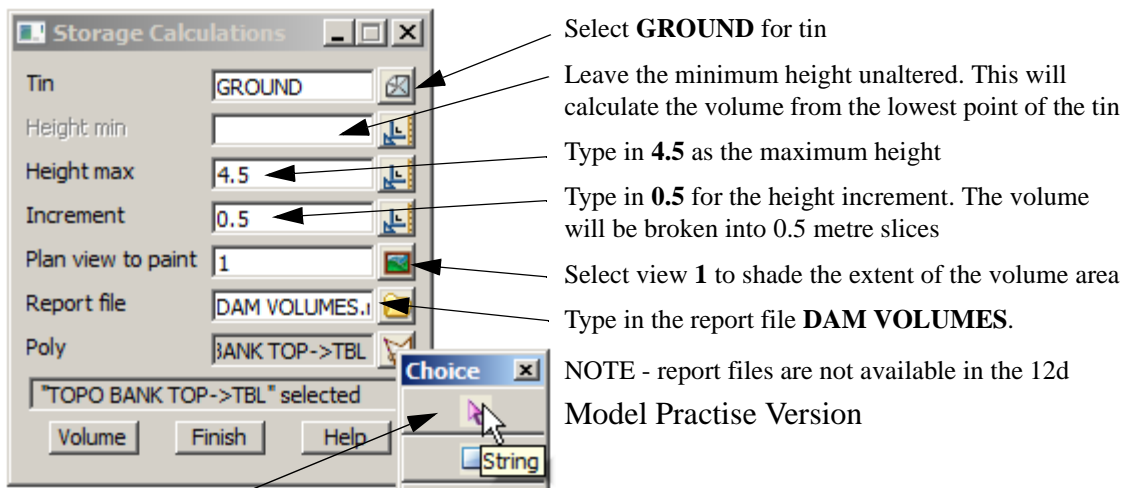

Select the **Poly** icon then pick and accept the string around the edge of the top of the dam wall

Select **Volume**

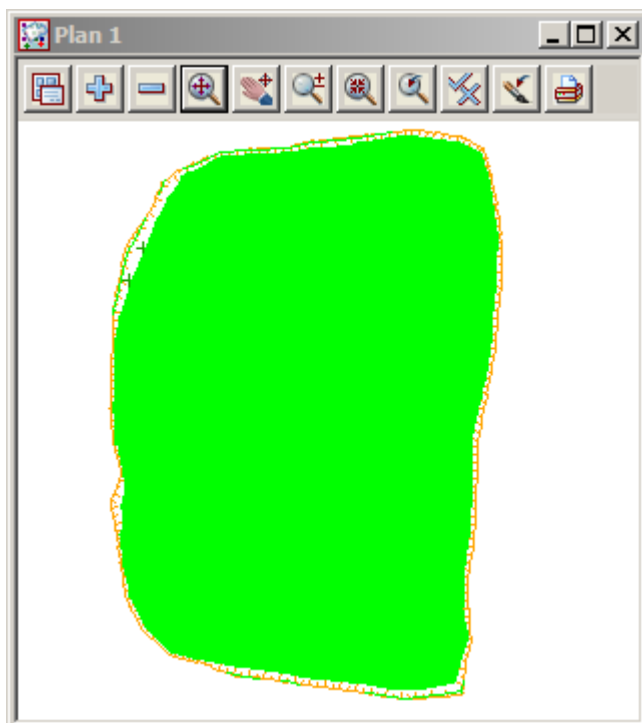

The extent of the tin up to the maximum height value is coloured

The report file is opened in the default text editor and the volumes are listed in the specified slices

DAM VOLUMES.rpt - Notepad

File Edit Format View Help

Project: DAM VOLUMES
 User: Noel
 Organization: 12d Training - Qld
 Report File: DAM VOLUMES.rpt

Storage calculations to tin "GROUND" - (with plan polygon "TOPO BANK TOP->TBL")
 cut volumes are negative
 fill volumes are positive

Height	Delta Ht	Vol to Height	Delta Vol	Plan Area	Delta Area	Slope Area	Delta Area
4.500	0.500	27649.689	5983.918	12333.331	721.723	12479.405	754.445
4.000	0.500	21665.771	5634.150	11611.607	681.485	11724.960	713.754
3.500	0.500	16031.621	5296.349	10930.123	682.844	11011.206	713.326
3.000	0.500	10735.272	4884.760	10247.279	1197.070	10297.880	1221.793
2.500	0.500	5850.511	3836.282	9050.208	3794.459	9076.087	3809.643
2.000	0.500	2014.230	1513.662	5255.749	3899.667	5266.443	3906.212
1.500	0.500	500.568	416.357	1356.082	918.944	1360.232	922.122
1.000	0.500	84.212	84.167	437.138	434.494	438.109	435.458
0.500	0.050	0.044	0.044	2.644	2.644	2.651	2.651
0.450	1.000	0.000	0.000	0.000	0.000	0.000	0.000
-0.550		0.000		0.000		0.000	

Polygon plan area = 12941.012

10.4 Surface Comparison

This topic deals with not only calculating the volume between two surfaces but also comparing the surfaces by depth shading

Create a new project as shown previously called **DEPTH SHADING** in the folder

C:\12d\9.00\Training\Survey\Volumes\DEPTH SHADING

Remember to select the configuration **GETTING STARTED SURVEY**

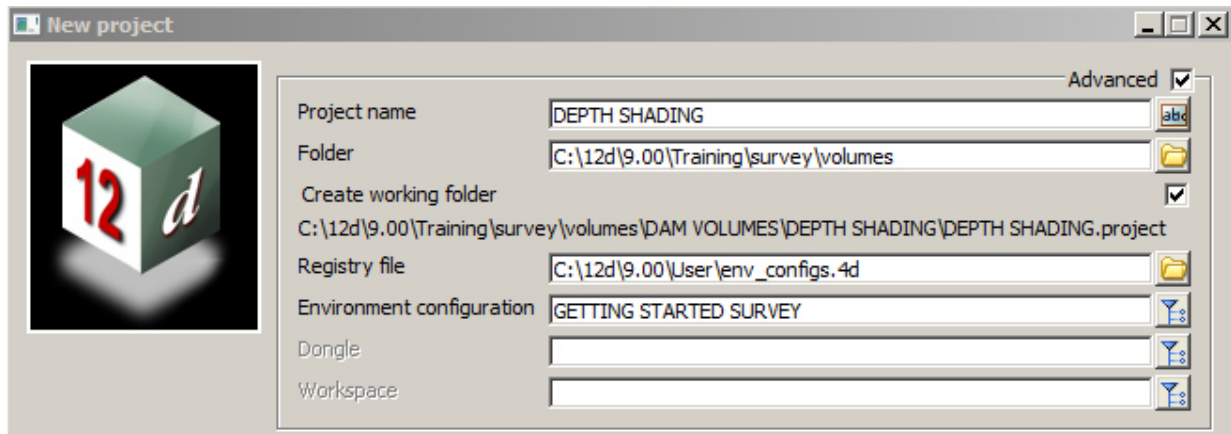

10.4.1 Read in Surfaces

We will read in the combined surface data for both surveys. The data is in the form of a 12d ascii file

Read in data

Select option **File I/O=>Data Input=>12da/4da data**

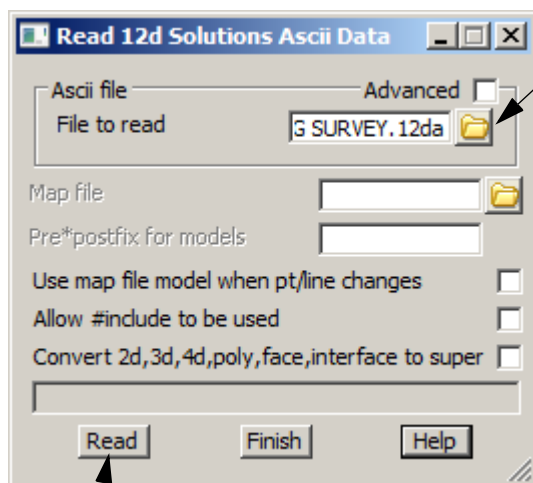

Select **Read** then **Finish**

Select the **Ascii file icon**

Browse to the folder

C:\12d\9.00\Training\survey\volumes

and select **DEPTH SHADING SURVEY.12da**

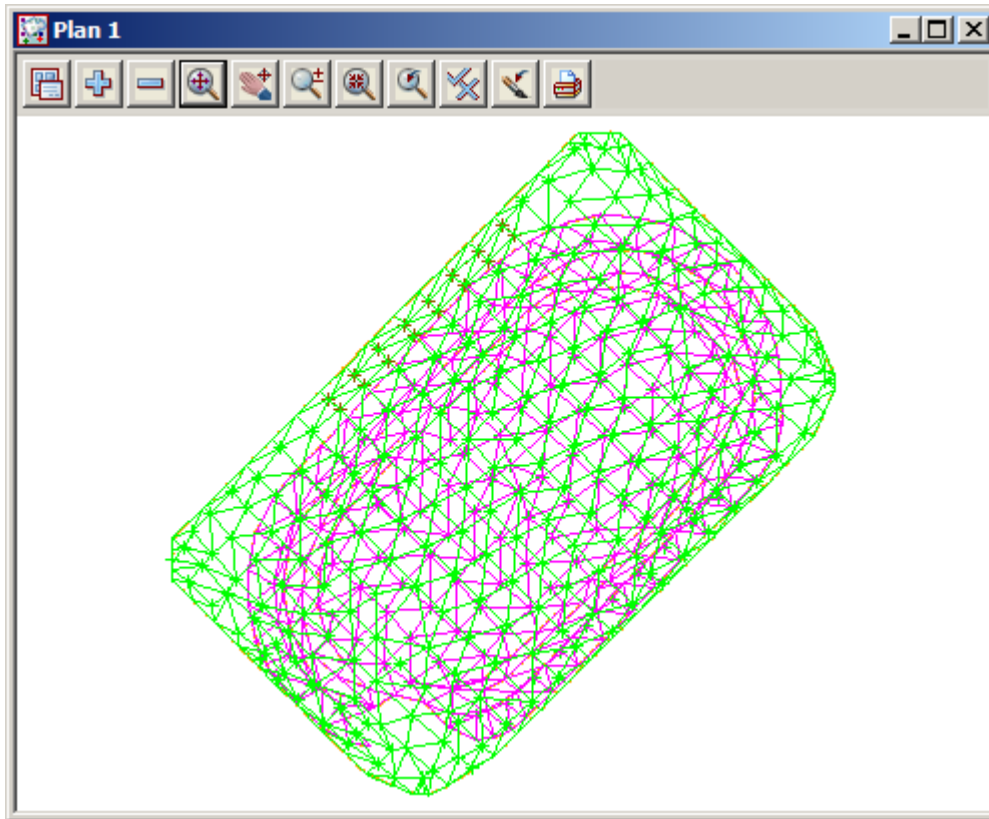

Turn off the Stripping survey models

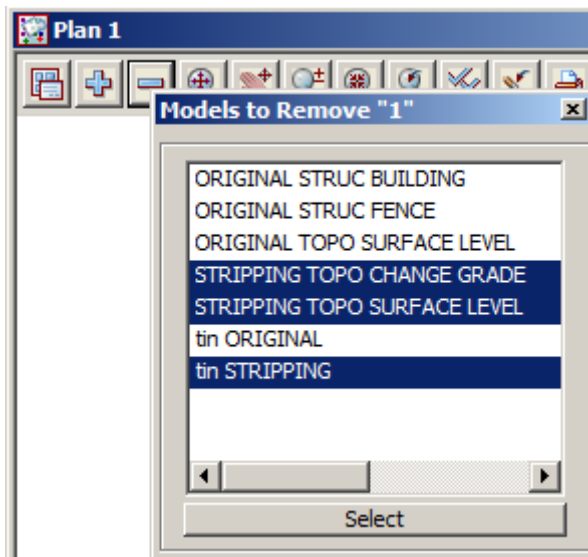

Check original data

Toggle on the contours. The contours are not visible as the surface is very flat. We need to change the contour interval to a smaller increment

Change the contour interval to 0.1

Select **Menu**. Walk right and select **Settings=>Tins=>Contours**

This menu will allow the user to change the appearance of the fast contours displayed on the view

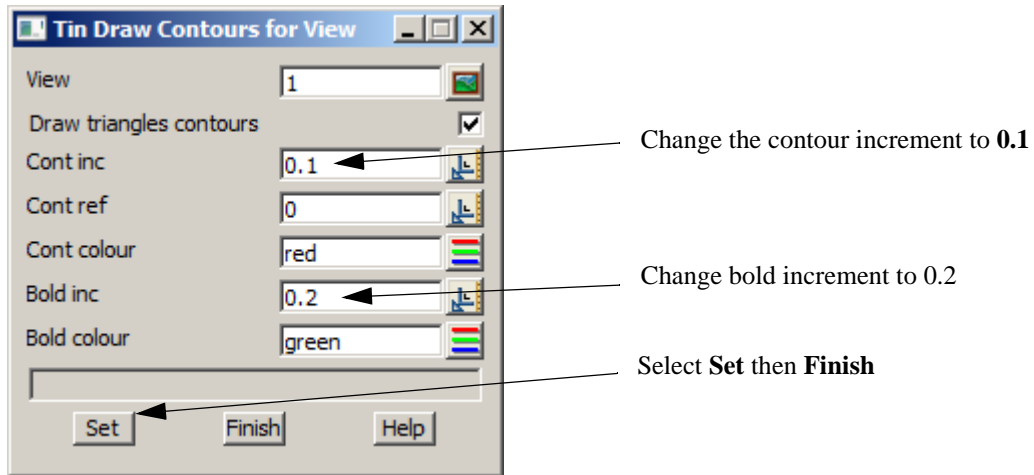

Save model list

The original models can be saved away to a model listing file

Select **View=>Models Save/Restore**

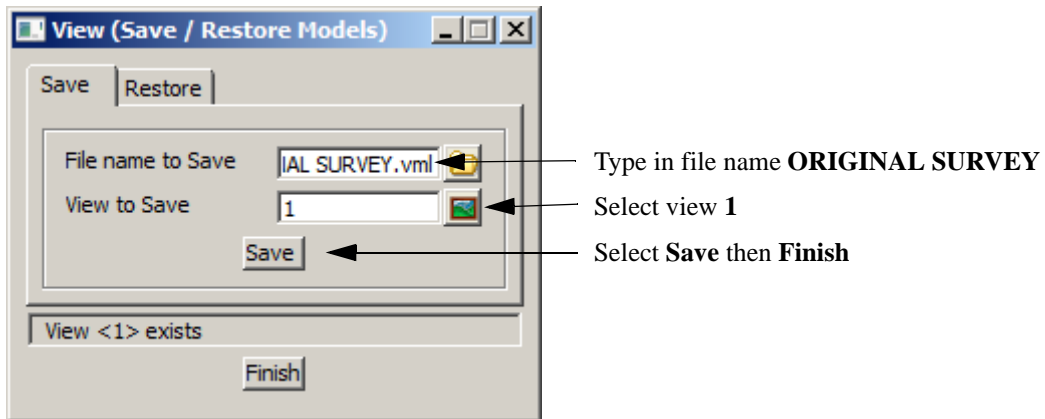

Check stripped survey data

Turn off all models then turn on the Stripping model and tin

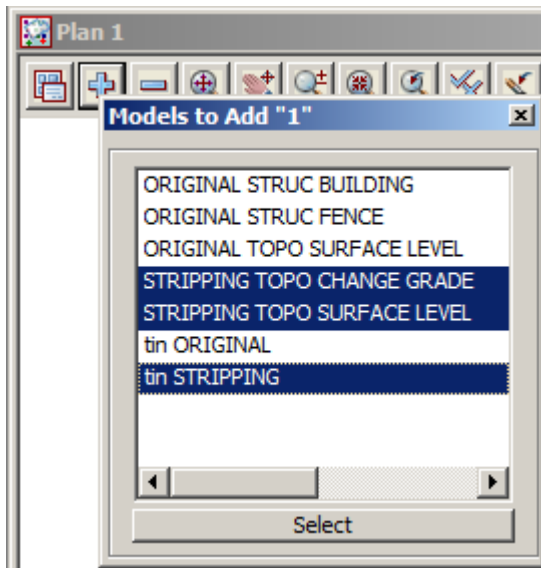

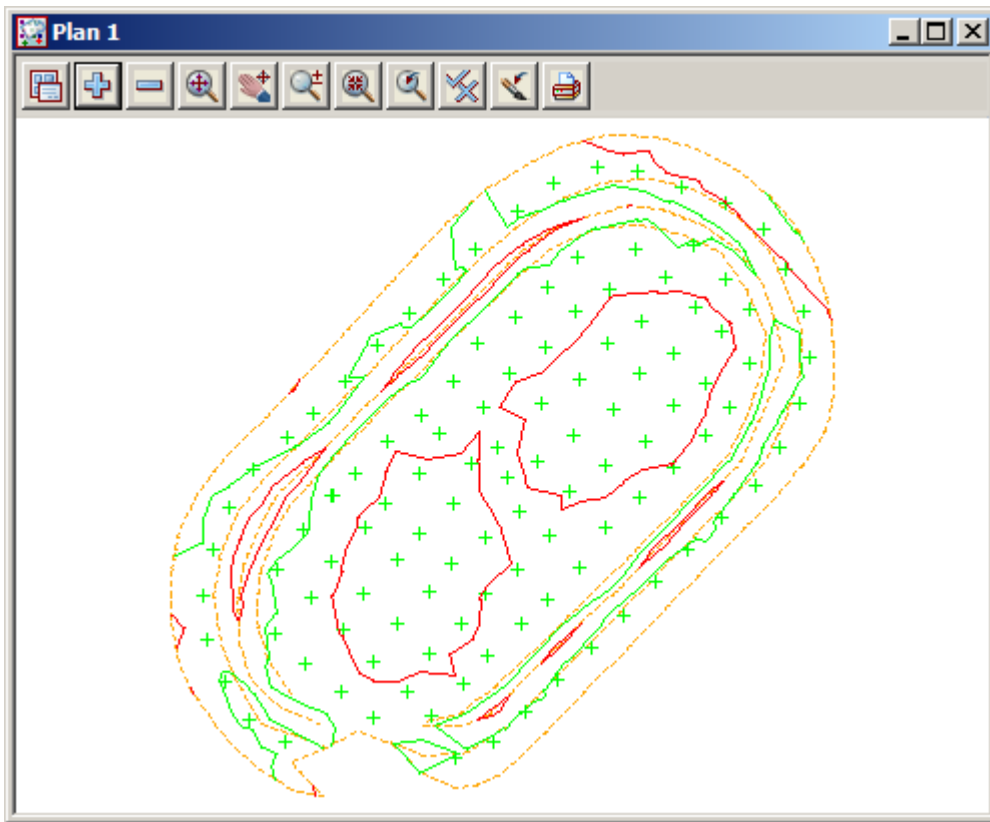

Save model list

The stripping models can be saved away to a model listing file

Select **View=>Models Save/Restore**

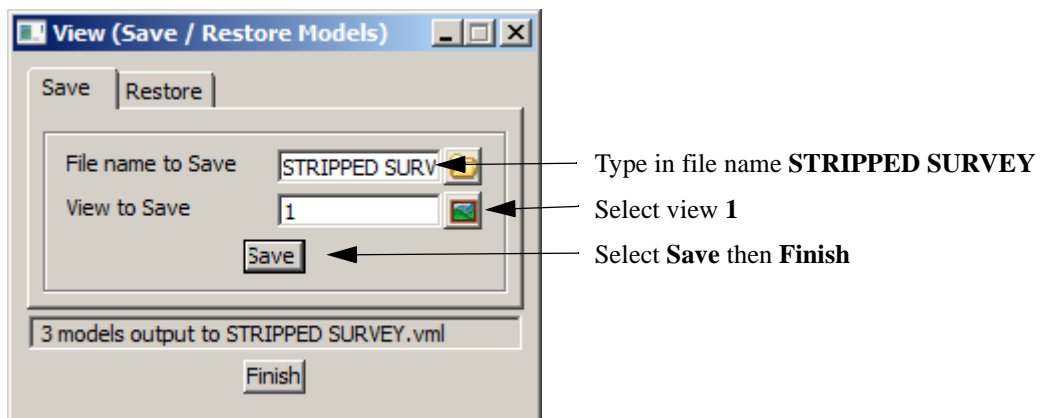

10.4.2 Check Stripped tin lies within existing tin

We will now turn on both triangle models to check that the Stripped tin sits inside the tin created from the existing surface points. If this is not the case then the volume calculation will only cover the area where the two tins coincide.

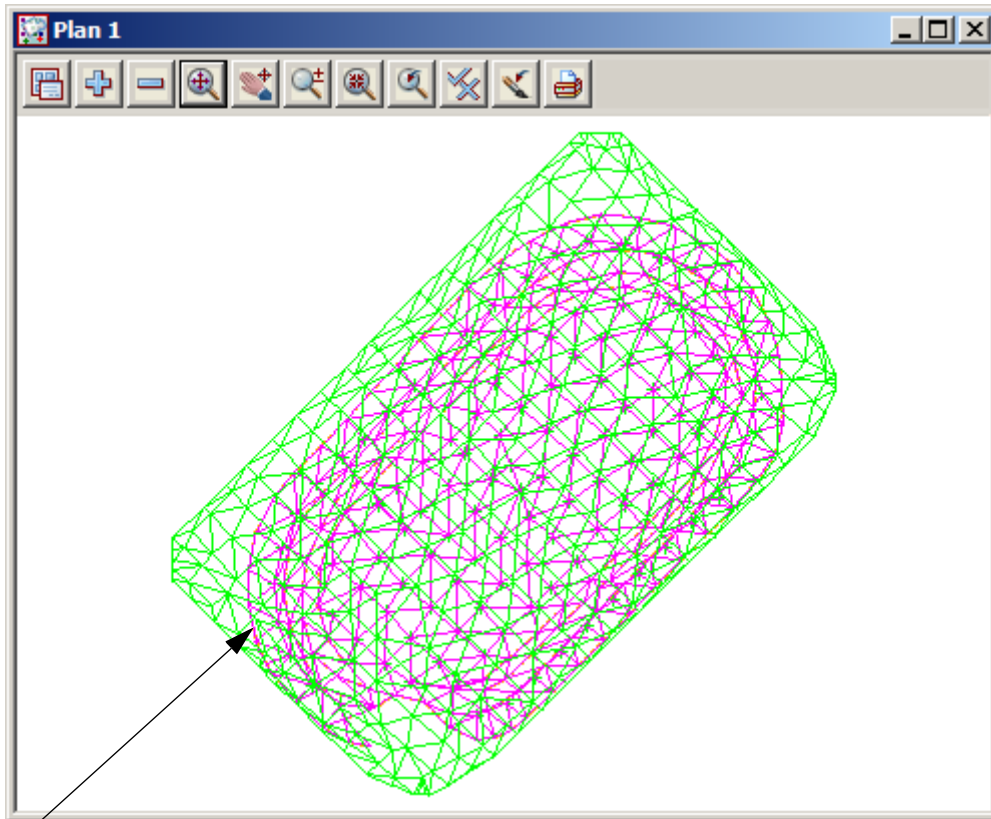

Ensure the outline of the stripping triangulation lies completely inside the original surface triangulation

10.4.3 Calculate volumes by exact method

The volume between the two tins can now be calculated and written to a report file

Select *Design=>Volumes=>Exact=>Tin to tin*

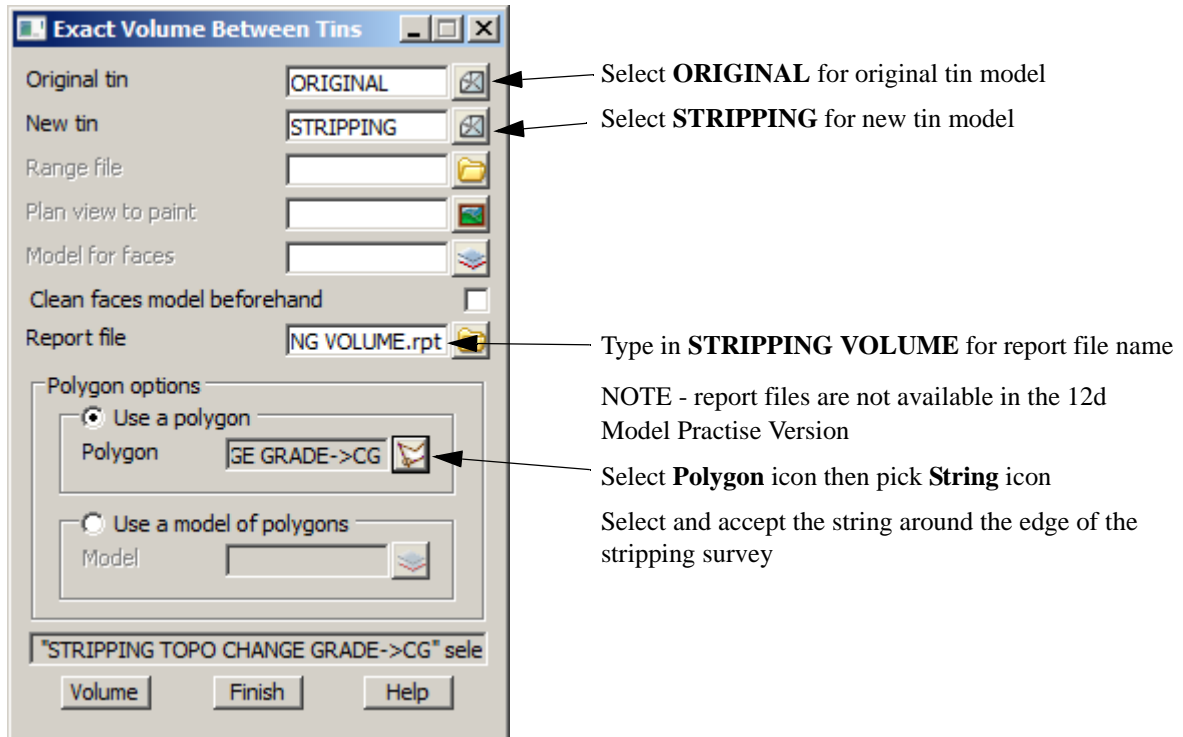

Select **Volume** to calculate the volume between the two surfaces

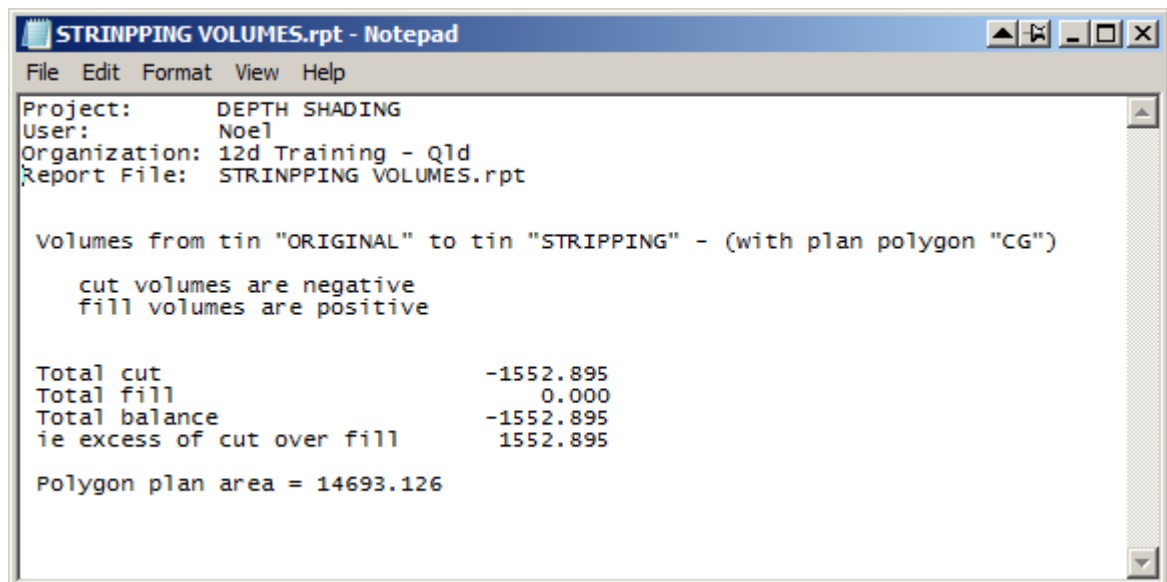

10.4.4 Create depth shading

The two surfaces can be compared by colouring the height differences

Turn off the tin models

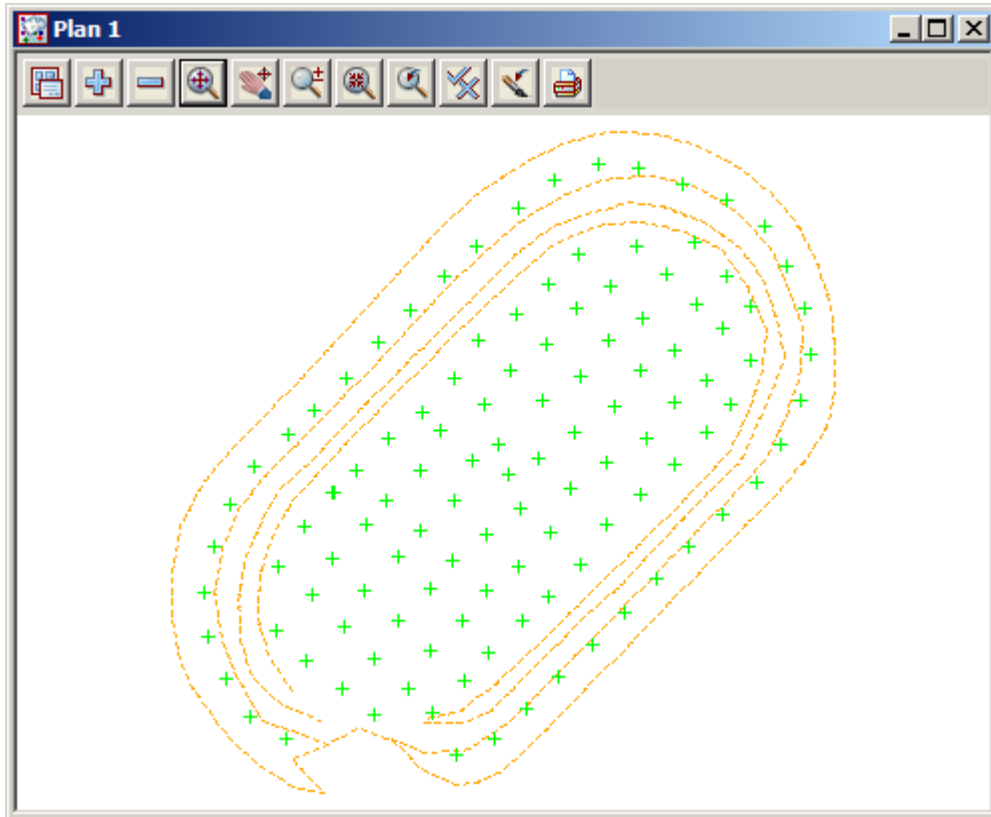

Select option *Tins=>Colour=>Tins depths colours*

Move the panel to the side of the survey

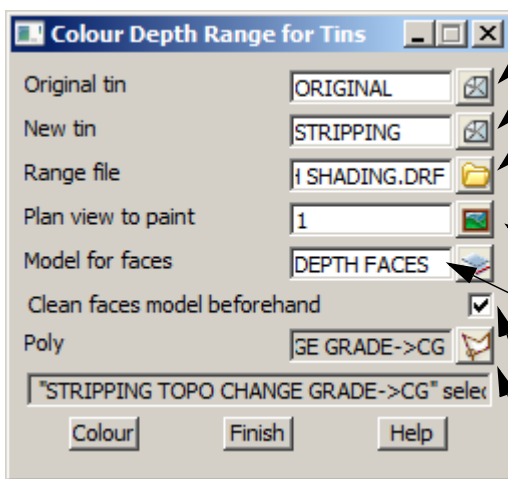

Select **Colour**

- Select **ORIGINAL** for original tin
- Select **STRIPPING** for new tin
- Select Range file icon then browse to the folder
- Browse to folder
- C:\12d\9.00\Training\survey\volumes** then select the file **DEPTH SHADING.drf**
- Select view **1** to paint
- Type in model **DEPTH FACES** for the colouring model.
- DO NOT ENTER A MODEL NAME IF USING PRACTICE VERSION AS A LARGE NUMBER OF STRINGS ARE CREATED
- Tick check box to clean faces model beforehand
- Select Poly choice icon
- Select the **String** icon then pick and accept the edge of the stripped surface

A preview of the colouring appears temporarily.

Turn on the model **DEPTH FACES**

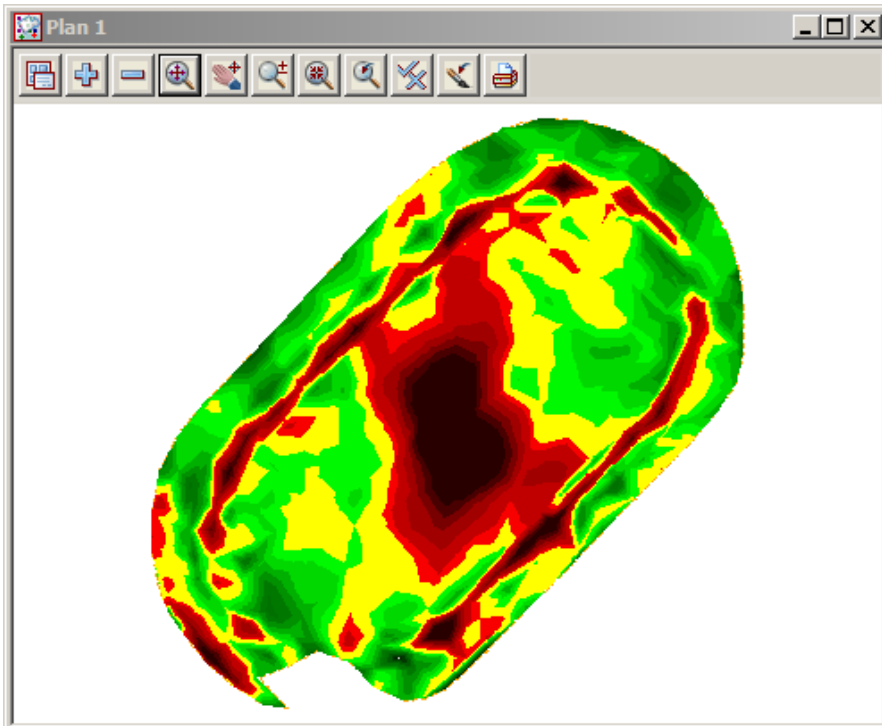

10.4.5 Create tabulation of range file

A table will be created to tabulate the depth colours

Select *Drafting=>Text and tables=>Tabulate range file*

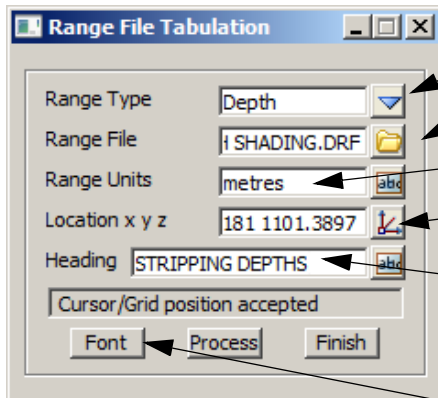

- Select **Range Type** icon and select **Depth**
- Select file **DEPTH SHADING.drf** from the folder **C:\12d\9.00\Training\survey\volumes**
- Type in **metres** for the range units
- Select Position icon. Pick and accept a point for the upper left corner of the propose table
- Type in **Stripping depths**

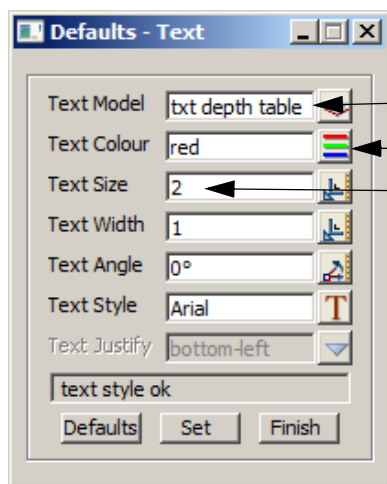

- Select **Font**
- Type in model name for table **txt depth table**
- Select the colour for the table
- Type in an appropriate size for the text. Note that the text size is in world units

Select **Set** then **Finish** to return to the previous panel

Select **Process**

Turn on the model **txt depth table**

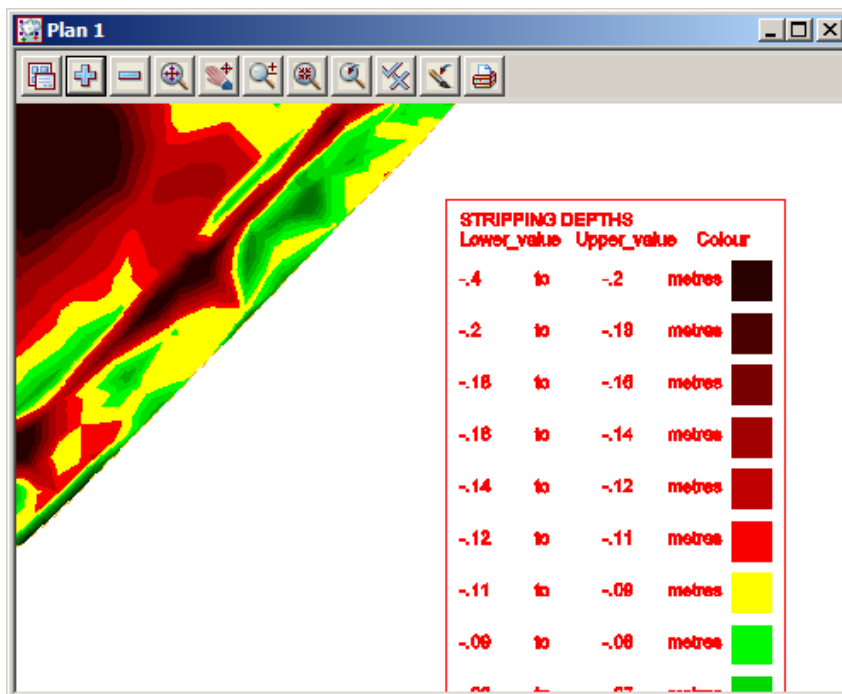

10.5 Progressive volumes

In this topic we will look at the use of fencing to update surfaces after each survey of an excavation. We will start with an existing surface and progressively update a combined surface after each survey

Create a new project as shown previously called **QUARRY** in the folder

C:\12d\9.00\Training\Survey\Volumes\QUARRY

Remember to select the configuration **GETTING STARTED SURVEY**

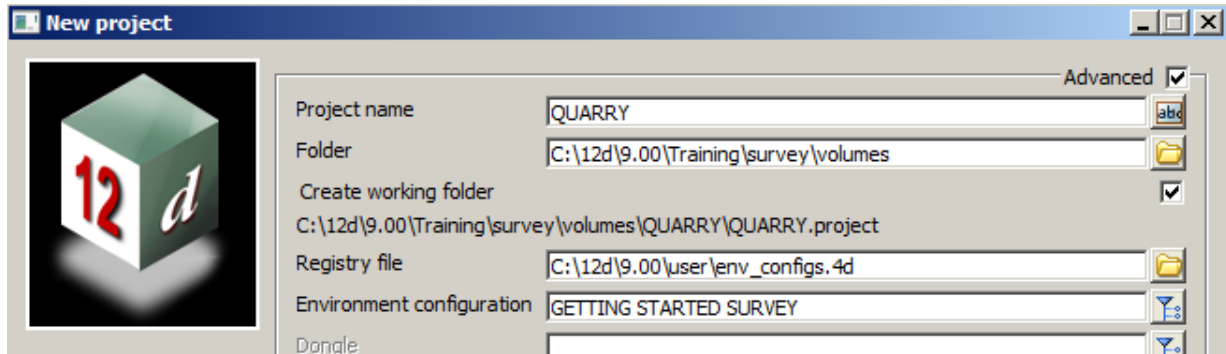

10.5.1 Read in multiple surveys

We will read in the data for the three surveys of a quarry as the excavation develops. The data has been given in the form of 3 12d ascii files. This time we will read the files in together in one option

Select option **File I/O=>Data Input=>12da/4da data**

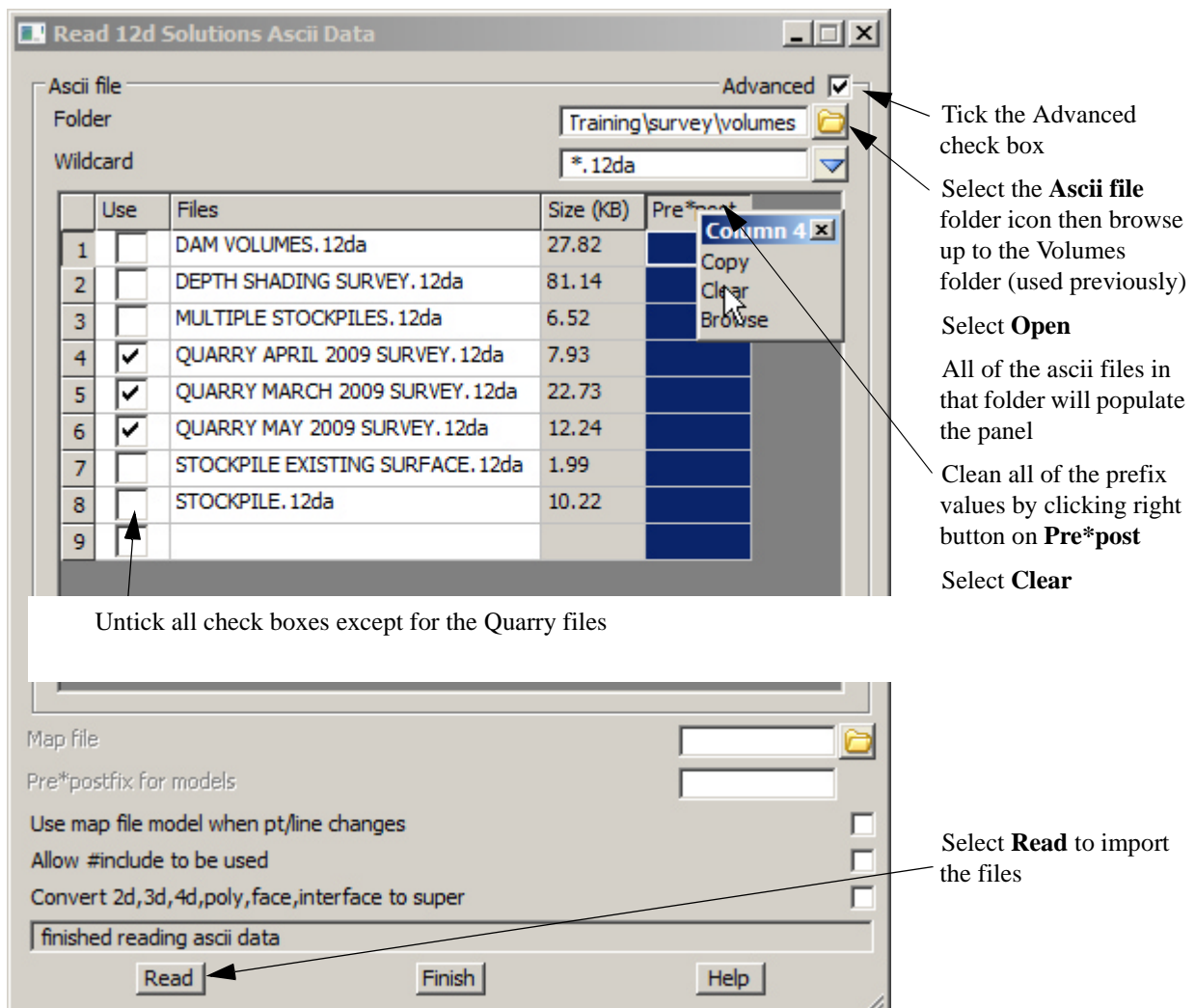

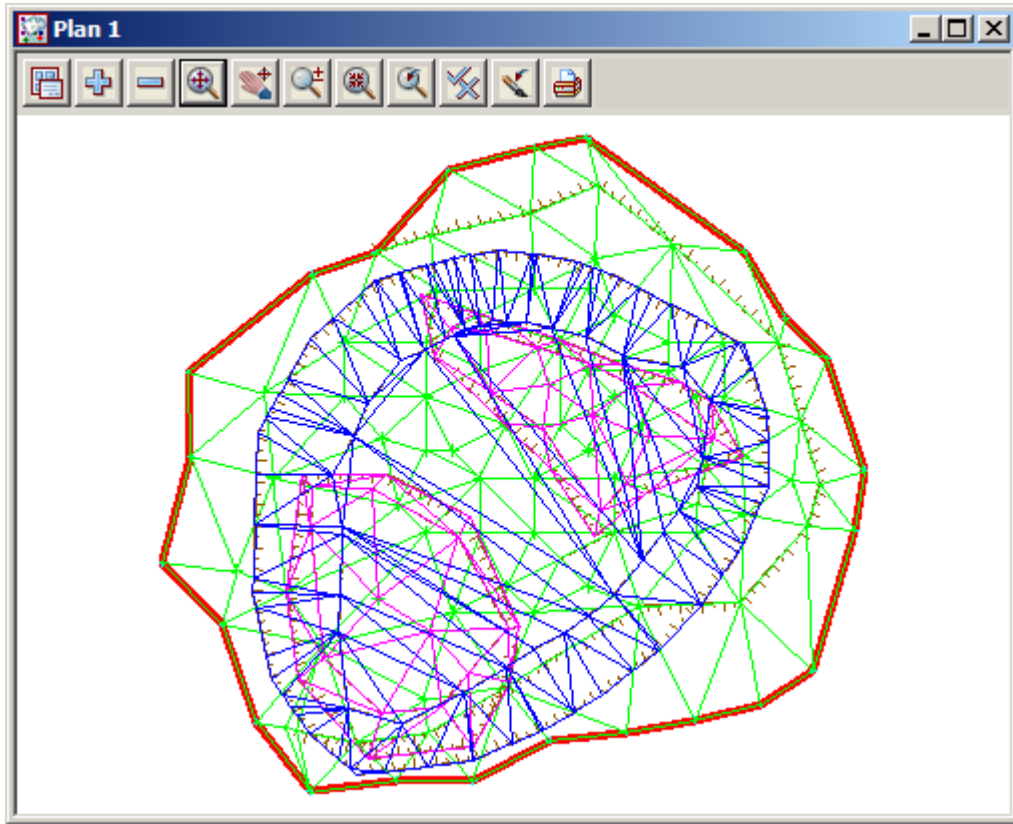

View March survey

Turn off all models except for the 200903 models and toggle on the contours

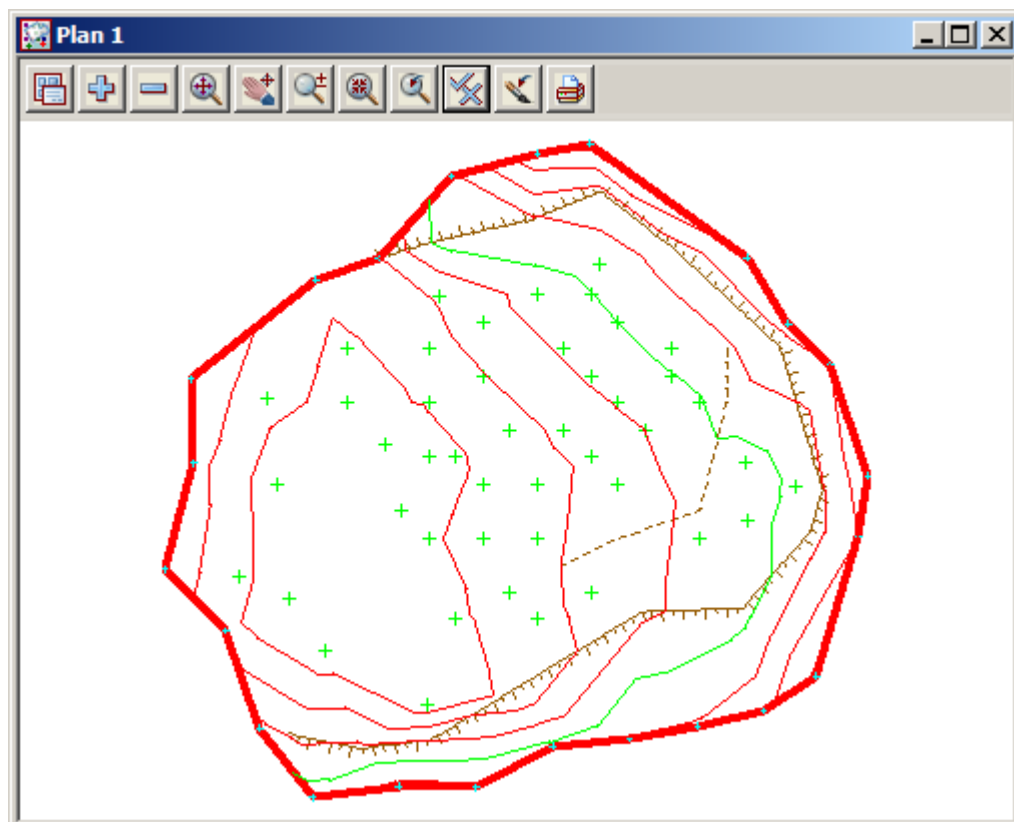
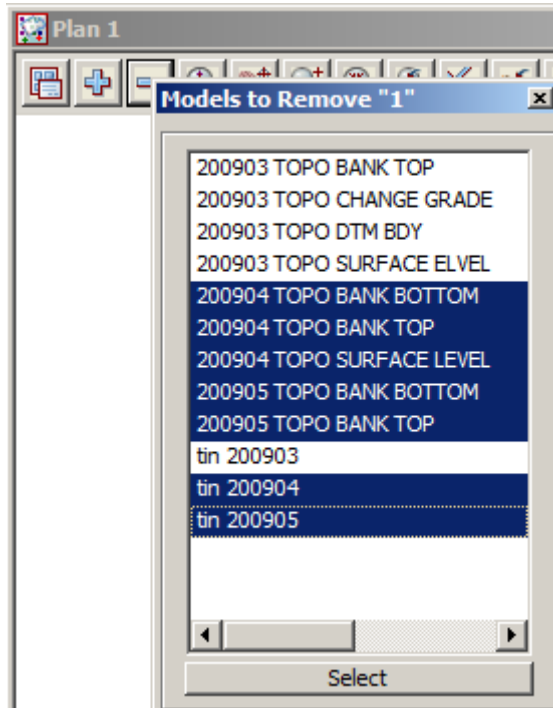

Save the March model list

The march survey models can be saved away to a model listing file

Select **View=>Models Save/Restore**

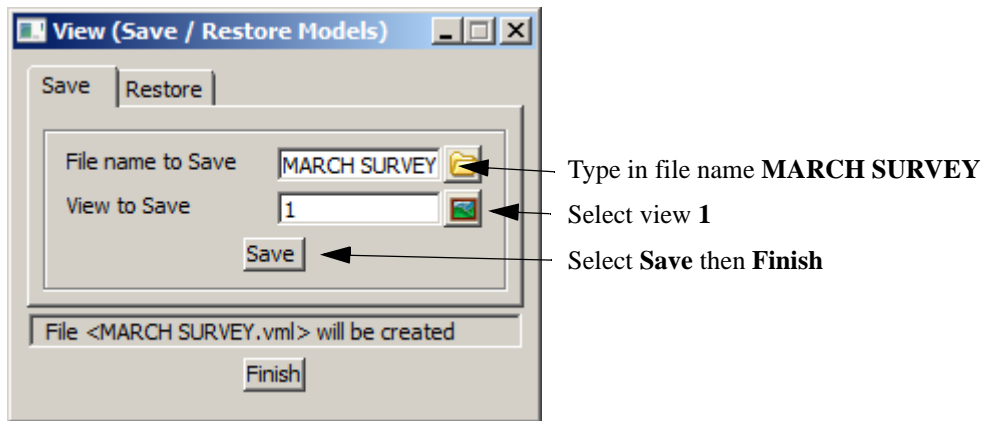

View April survey

Turn off all models then add the 200904 models

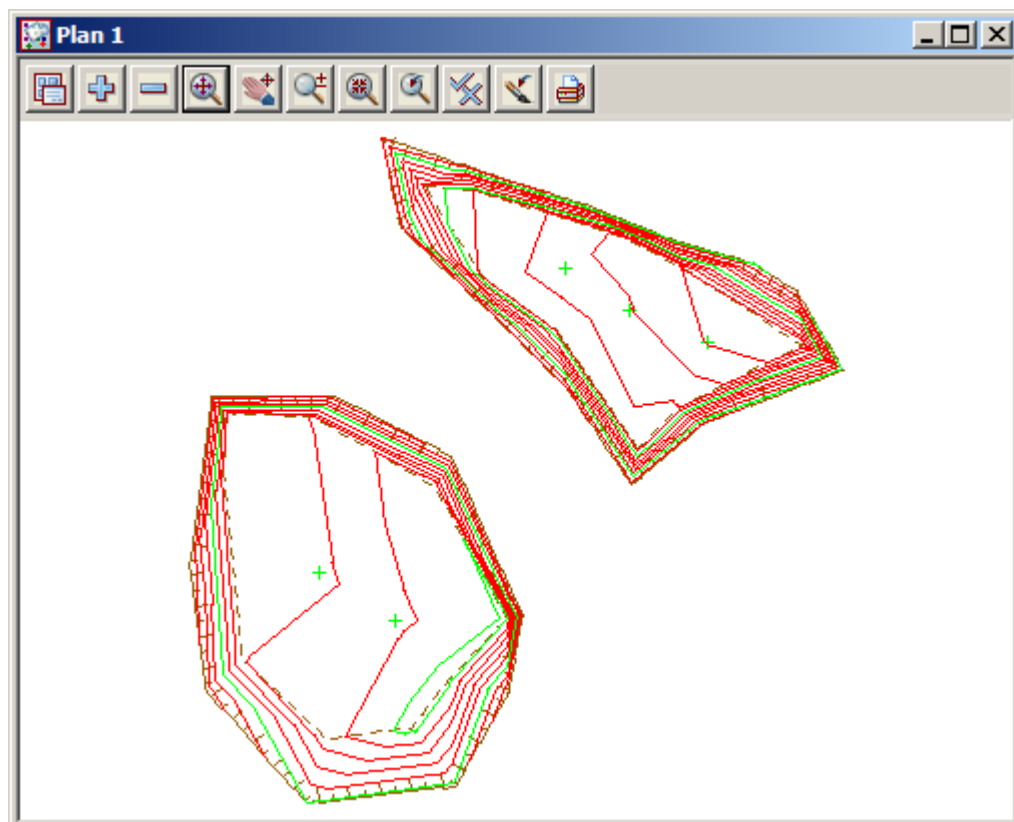
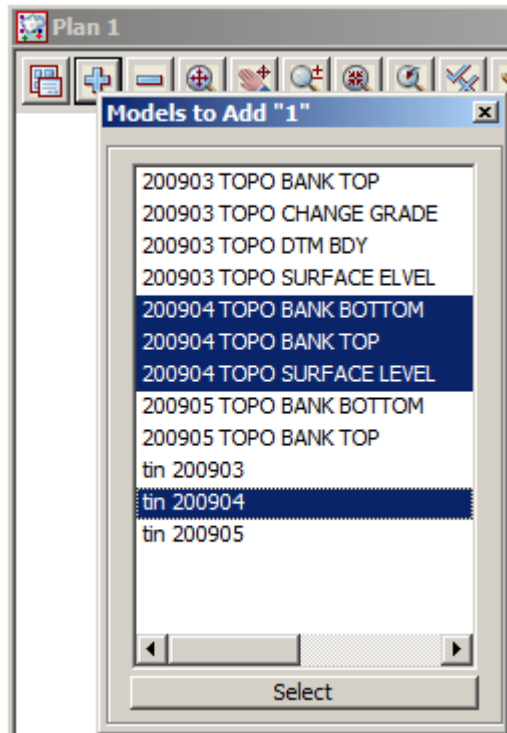

Save the April model list

The April survey models can be saved away to a model listing file

Select **View=>Models Save/Restore**

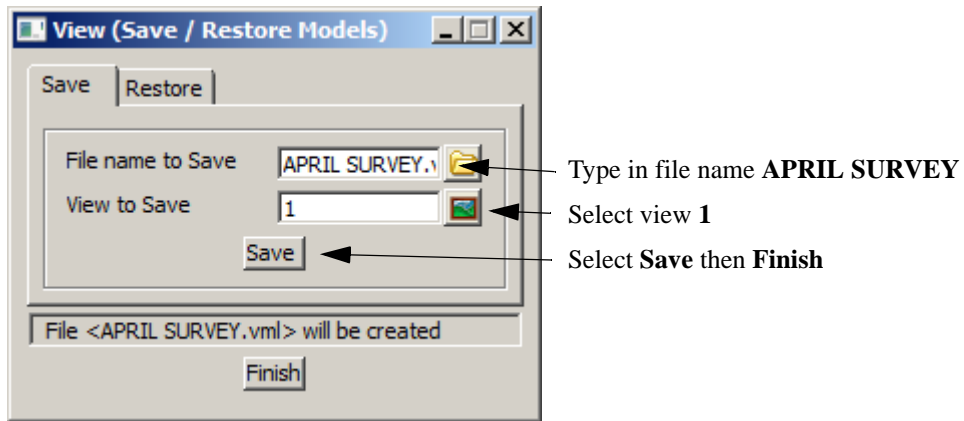

View May survey

Turn off all models then add the 200905 models

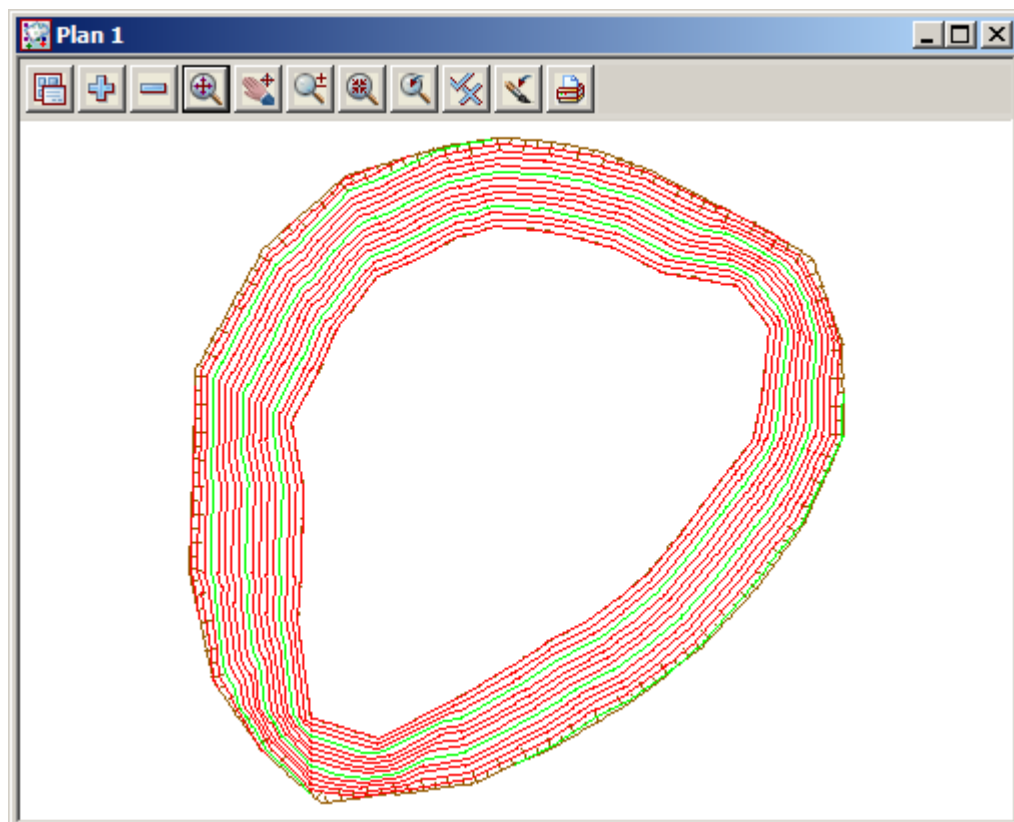
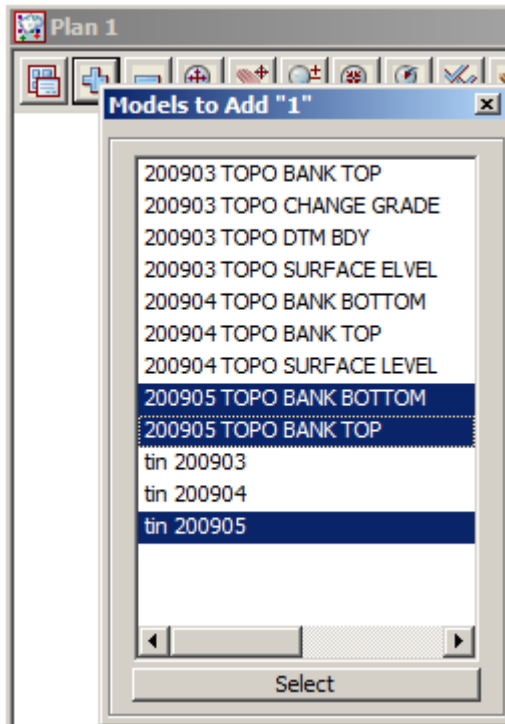

Save the May model list

The May survey models can be saved away to a model listing file

Select **View=>Models Save/Restore**

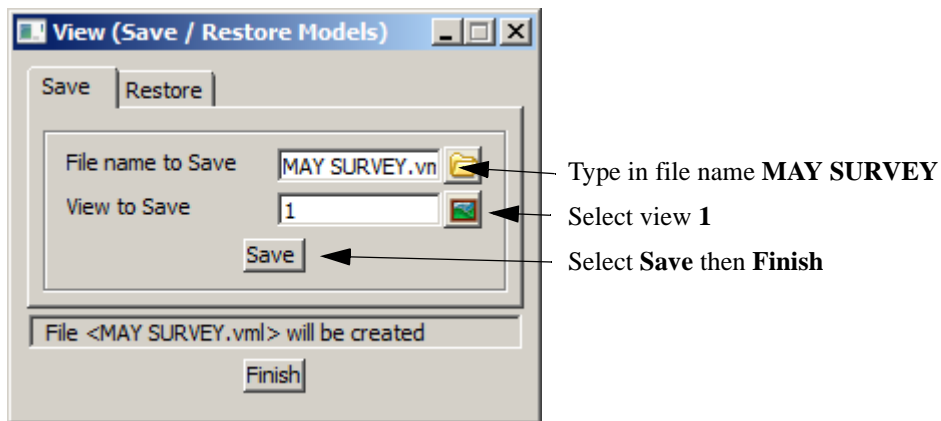

10.5.2 Check April and May tin lies within March tin

Turn off all models then turn on all of the tins

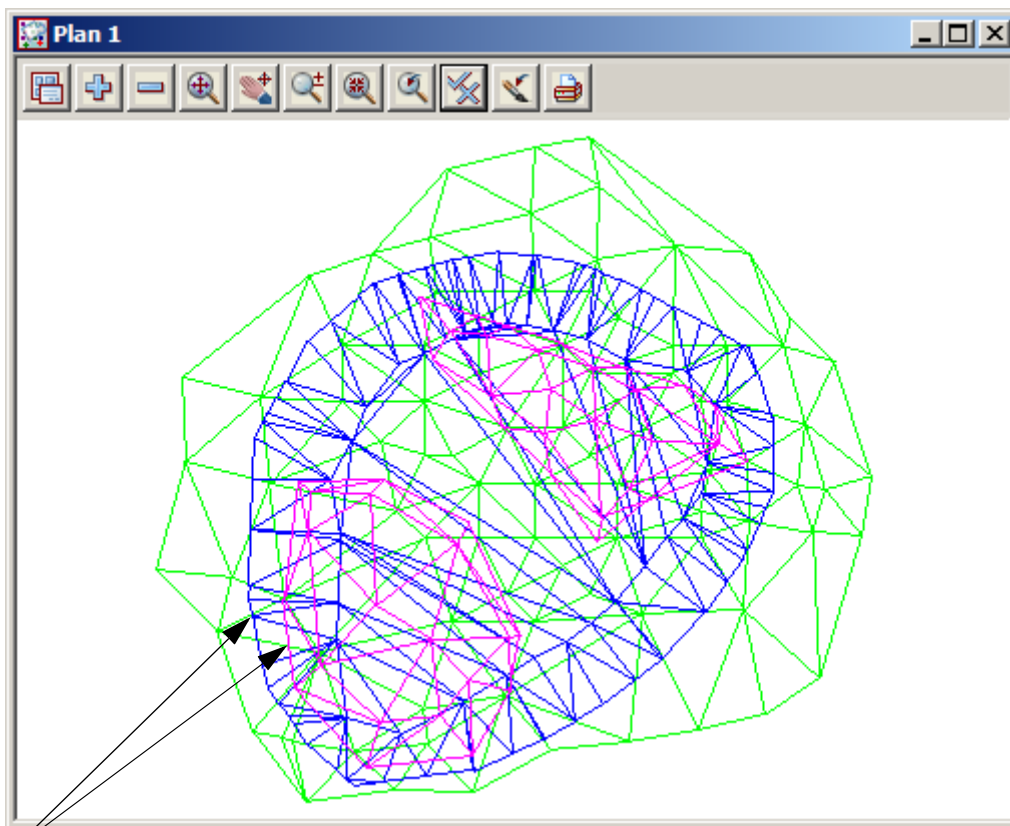

Ensure the outline of the April and May triangulations lies completely inside the March triangulation

Shade tins

Shading the tins can help with the checking of the overlapping

Toggle on **Tin solid**

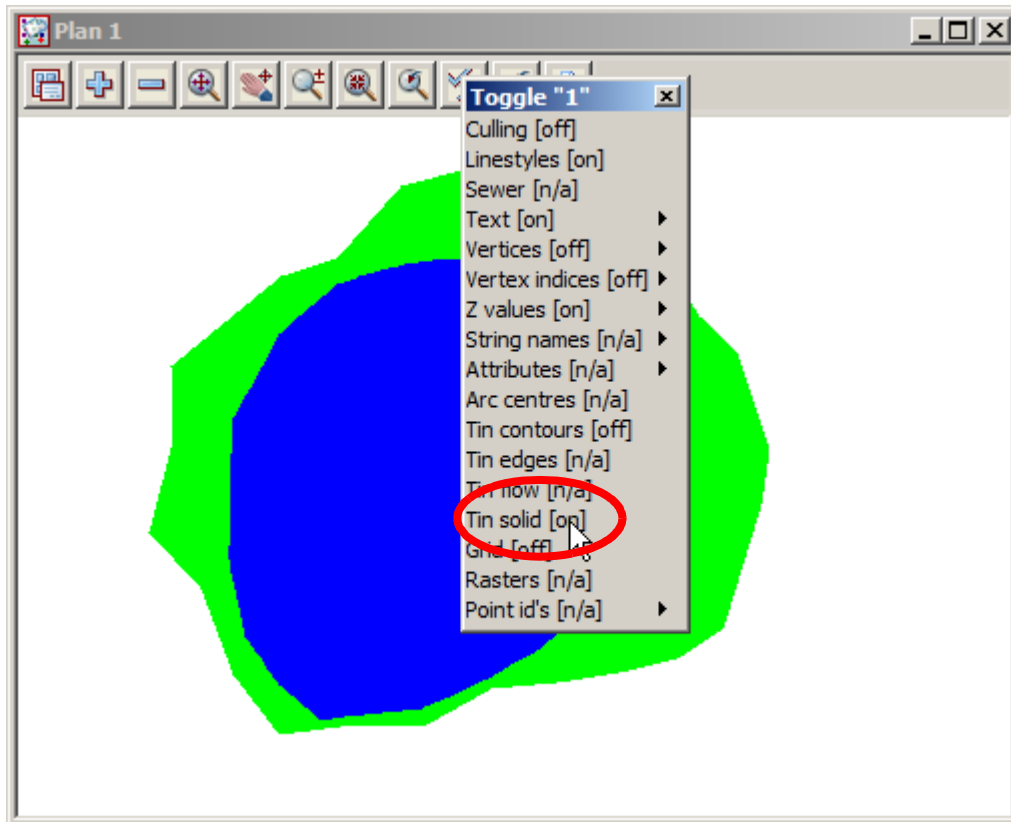

As the April tin is smaller in area than the May tin it is hidden by the May tin colouring. To make the April tin visible we can move the April tin model to the front of the display

Select **Menu**. Walk right and select **Models=>Models to front**. Select **tin 200904**

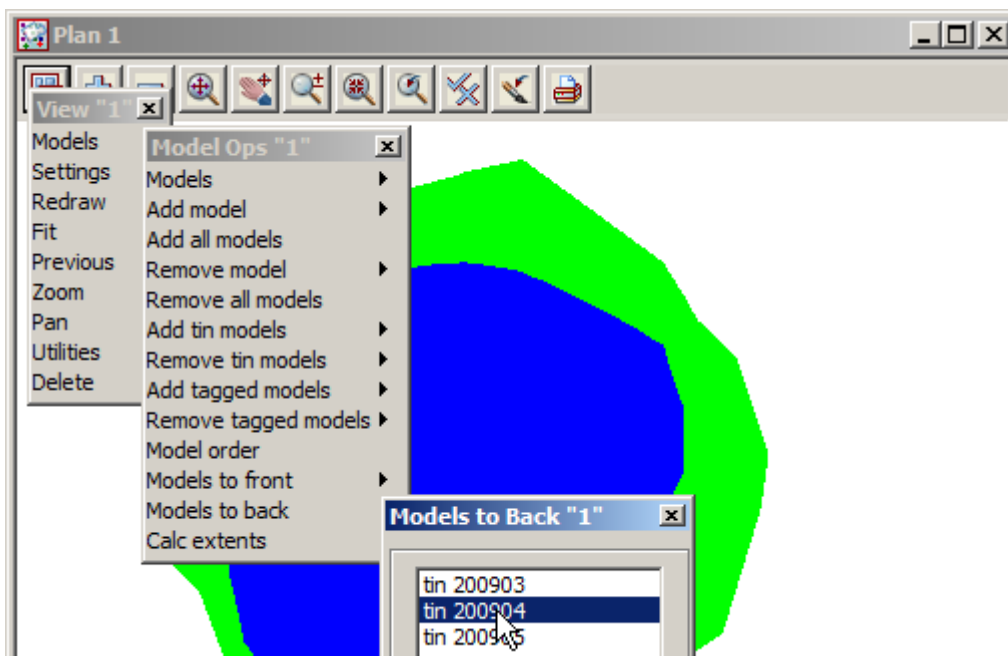

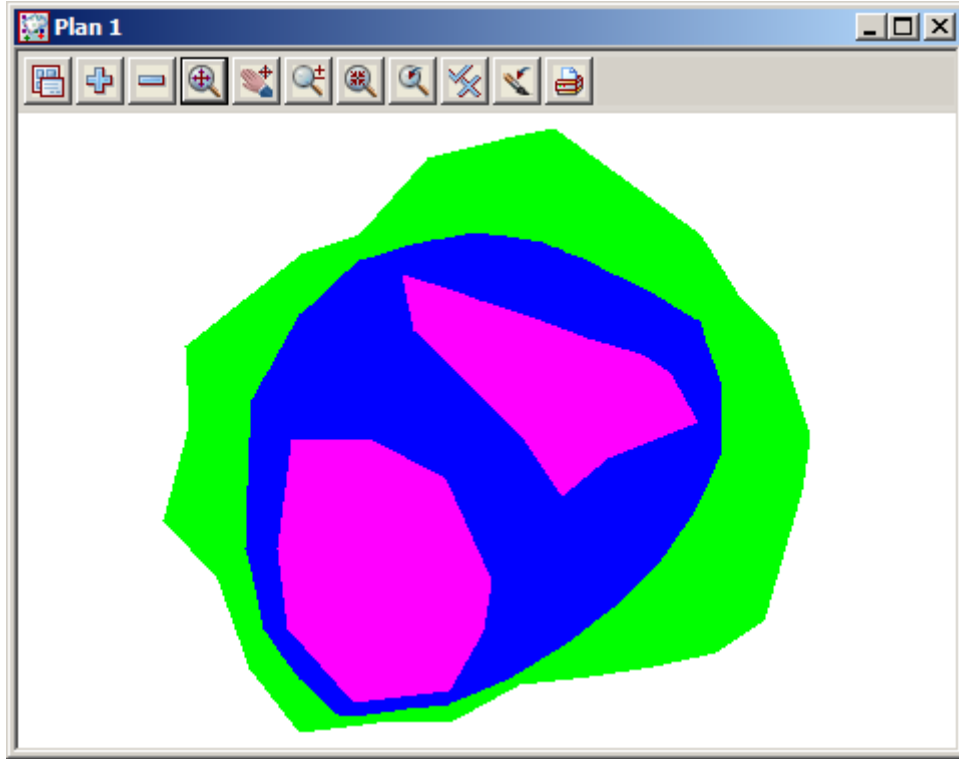

Toggle off the **Tin solid**

10.5.3 Calculate volumes from March to April survey

We will now calculate the volumes between the March and April survey

Firstly turn off all models then read back in the April survey. We will do this by reading in the model list previously created

Restore the April model list

Select *View=>Models Save/Restore*

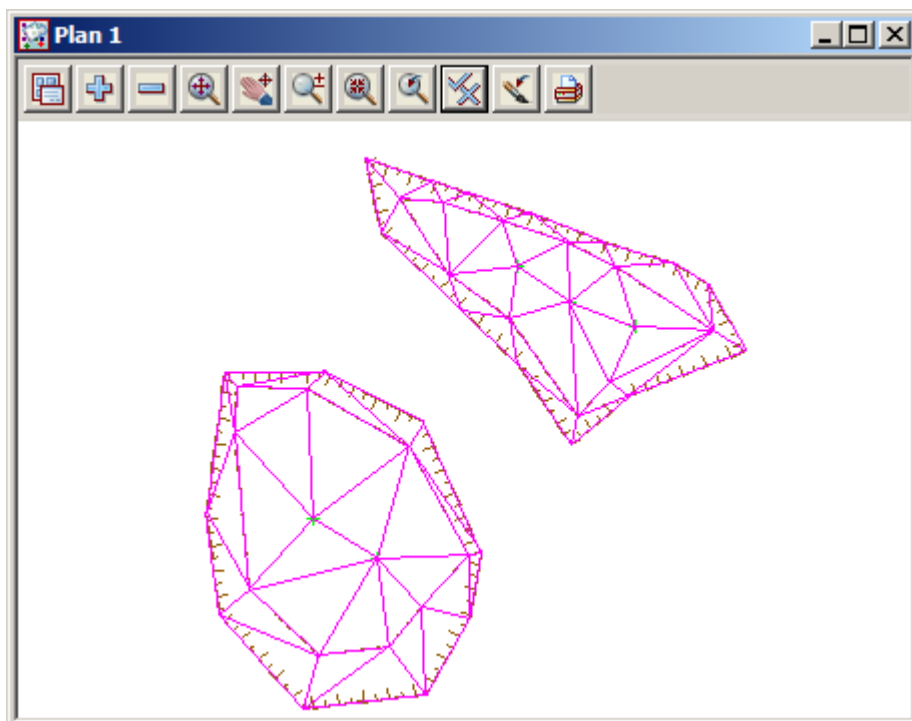
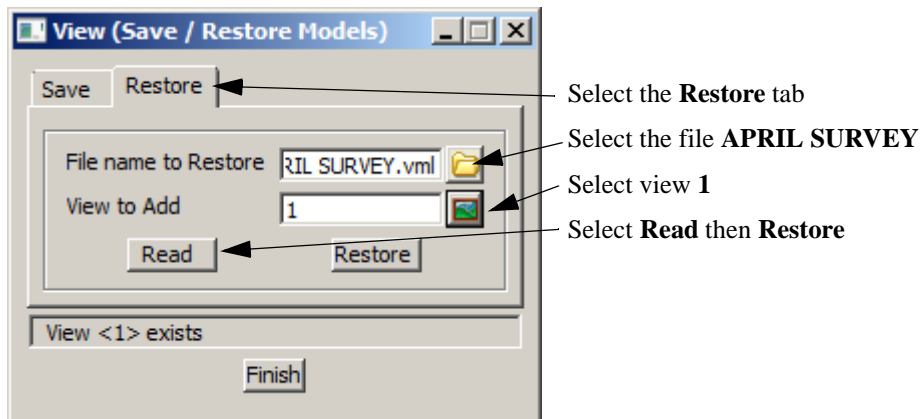

Calculate EXACT TIN TO TIN volumes

The volume between the two tins can now be calculated and written to a report file. We will use two methods for the volumes. Firstly we will calculate using the tin to tin exact method. Next we will use a height range file to break the volumes up into horizontal slices at user defined heights

Select **Design=>Volumes=>Exact=>Tin to tin**

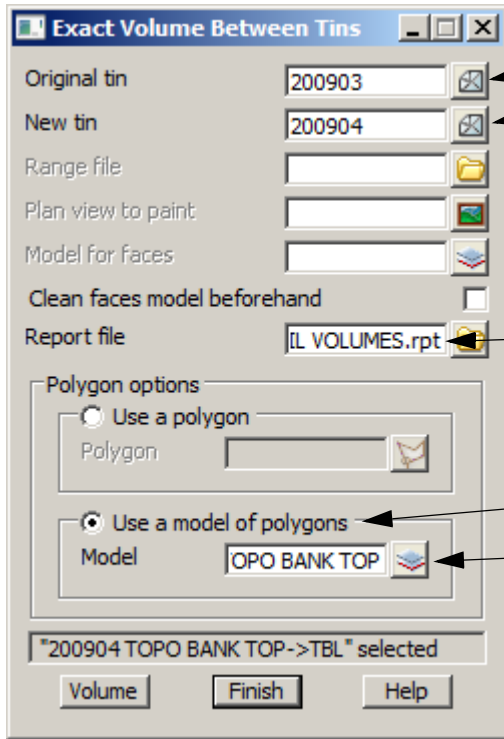

Select **200903** for original tin model

Select **200904** for new tin model

Type in **APRIL VOLUMES** for report file name

NOTE - report files are not available in the 12d Model Practise Version

Select **Use a model of polygons**

Select model **200904 TOPO BANK TOP** for the edge of the excavations

Select **Volume** to calculate the volume between the two surfaces

The volume report is opened in the default text editor with separate volumes for each pit

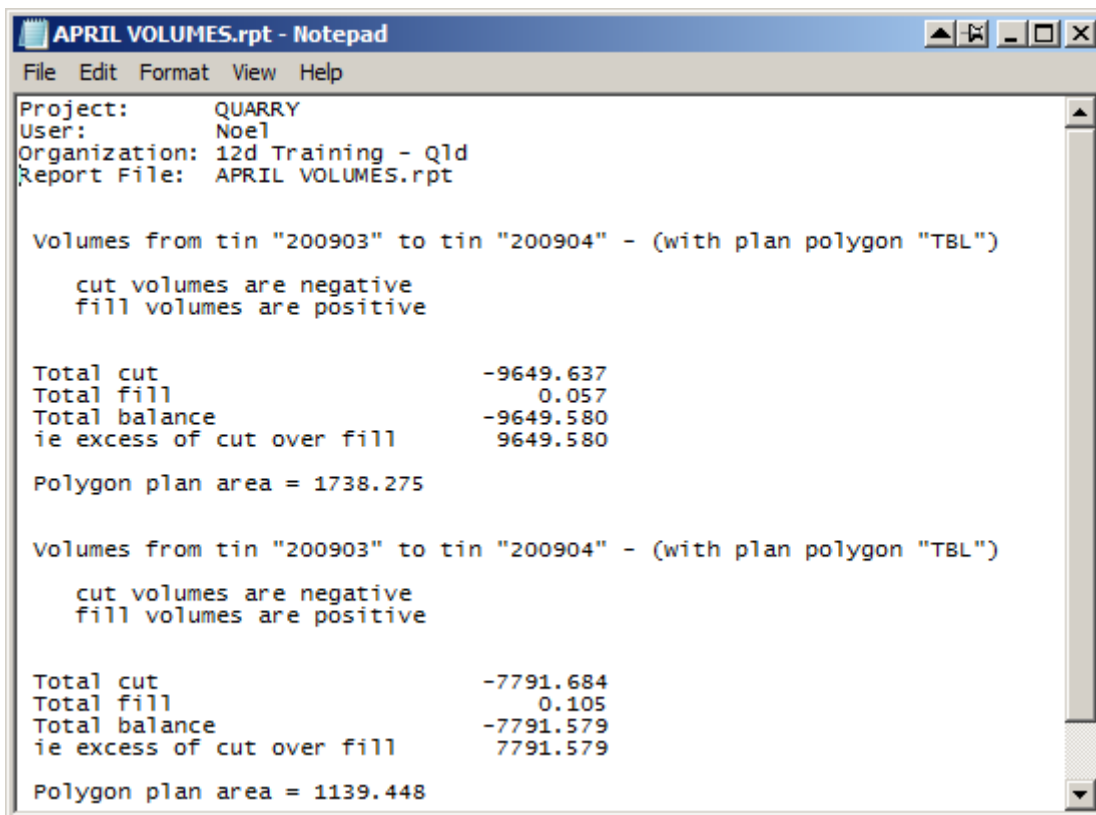

Calculate TIN TO TIN BY HEIGHT RANGE volumes

Select *Design=>Volumes=>Tin to tin ht range*

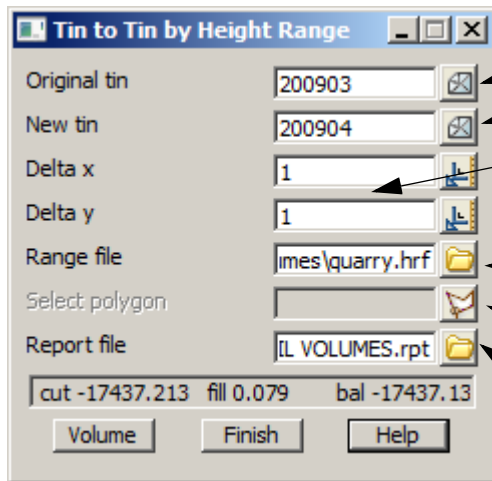

- Select **200903** for original tin model
- Select **200904** for new tin model
- Type in 1 for the delta x and delta y spacing
This will calculate the volumes based on a 1 metre grid
- Browse up to the Volumes folder and select the height range file **quarry.hrf**
- As there are two excavations **do not** pick a polygon
- Select the previous report file APRIL VOLUMES to append to
- Select **Volume** to calculate the volume between the two surfaces

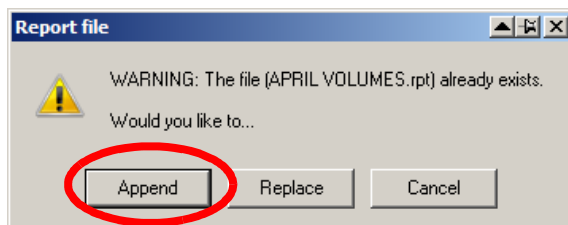

Select Append to add to the bottom of the previous report file

The volume report is opened in the default text editor with a total volume of the two pits. Adding the two pit volumes from the tin to tin method gives a close comparison to this volume.

```
Project:    QUARRY
User:      Noel
Organization: 12d Training - Q1d
Report File: APRIL VOLUMES.rpt
```

Volumes from tin "200903" to tin "200904" - (with no plan polygon)

Height		Incremental		Accumulative		
1	2	Cut	Fill	Cut	Fill	Balance
60.000	61.000	0.000	0.000	0.000	0.000	0.000
61.000	62.000	0.000	0.000	0.000	0.000	0.000
62.000	63.000	0.000	0.000	0.000	0.000	0.000
63.000	64.000	0.000	0.000	0.000	0.000	0.000
64.000	65.000	0.000	0.000	0.000	0.000	0.000
65.000	66.000	-23.204	0.000	-23.204	0.000	-23.204
66.000	67.000	-153.006	0.000	-176.209	0.000	-176.209
67.000	68.000	-349.757	0.000	-525.966	0.000	-525.966
68.000	69.000	-586.150	0.000	-1112.116	0.000	-1112.116
69.000	70.000	-726.380	0.000	-1838.496	0.000	-1838.496
70.000	71.000	-998.819	0.000	-2837.316	0.000	-2837.316
71.000	72.000	-1431.823	0.000	-4269.138	0.000	-4269.138
72.000	73.000	-2018.280	0.000	-6287.418	0.000	-6287.418
73.000	74.000	-2288.754	0.000	-8576.172	0.000	-8576.172
74.000	75.000	-2463.660	0.000	-11039.832	0.000	-11039.832
75.000	76.000	-2449.128	0.068	-13488.960	0.068	-13488.892
76.000	77.000	-2010.691	0.000	-15499.651	0.068	-15499.583
77.000	78.000	-1436.249	0.000	-16935.899	0.068	-16935.831
78.000	79.000	-501.314	0.011	-17437.213	0.079	-17437.134
79.000	80.000	0.000	0.000	-17437.213	0.079	-17437.134
Total cut		-17437.213				
Total fill		0.079				
Total balance		-17437.134				
ie excess of cut over fill		17437.134				

10.5.4 Combine the March and April surfaces

We need to make a copy of the March survey that falls outside the edge of the April survey.

Parallel top of banks

Prior to fencing the data we will parallel the top of batters out 10 millimetres so that the end of the cut strings don't sit right on top of the batters. This would create crossing breaklines and could create errors at the fencing edge

We will add a new model for the parallel lines

Set up the cad control bar as shown below

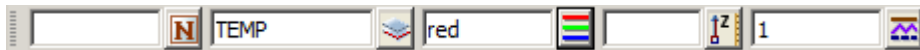

Parallel the two strings using the option *Cad Strings=>Strings Parallel*

Pick with direction along the edge of the first top of bank string

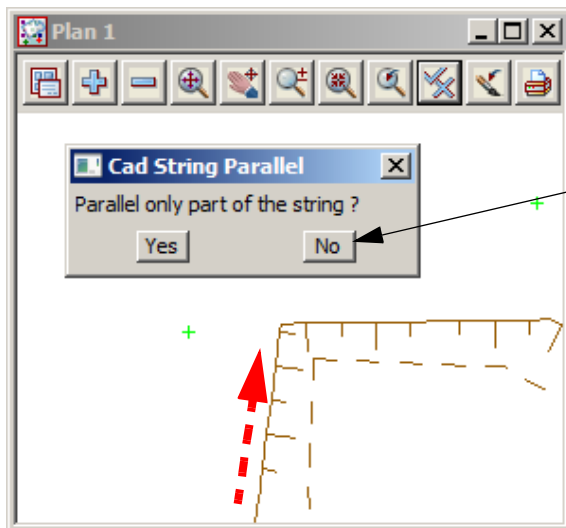
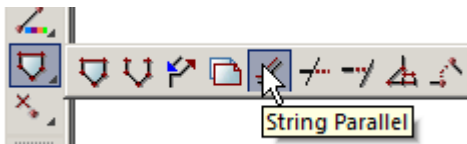

Select **No** to parallel the whole of the string

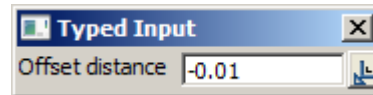

Type in **-0.01 [Enter]**

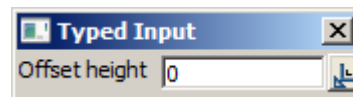

Press **[Enter]** to accept the offset

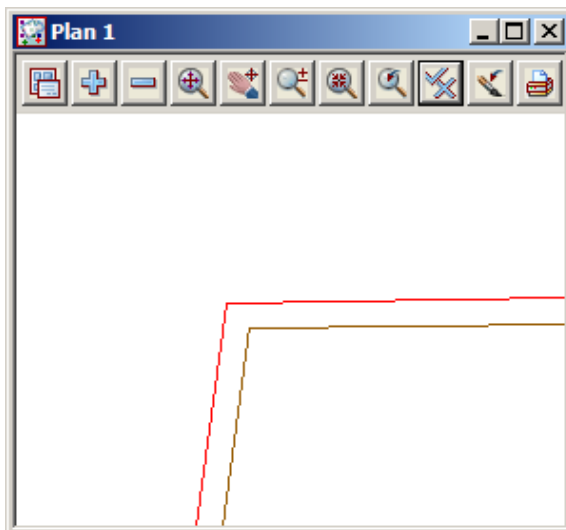

Repeat for the second top of bank

Fence the March survey

We will use the fencing routine to save the data outside the limit of the April survey excavations to a new model.

Turn off all models

Turn on the **20903** models along with the **TEMP** top of excavations

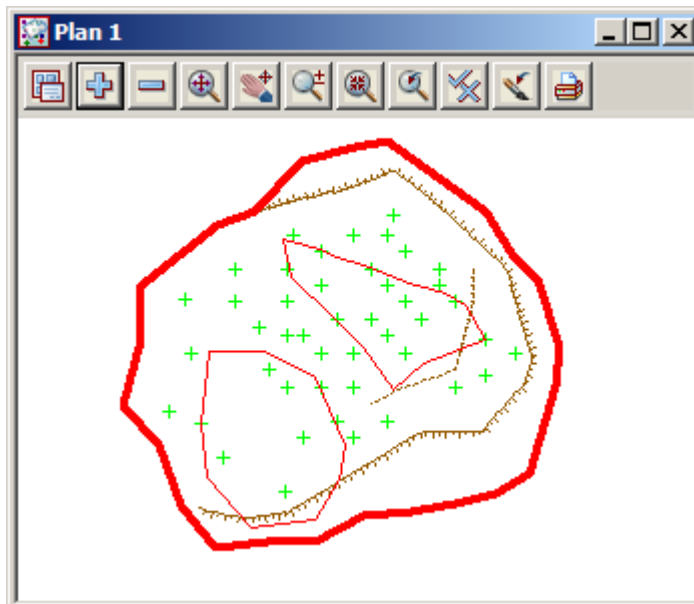
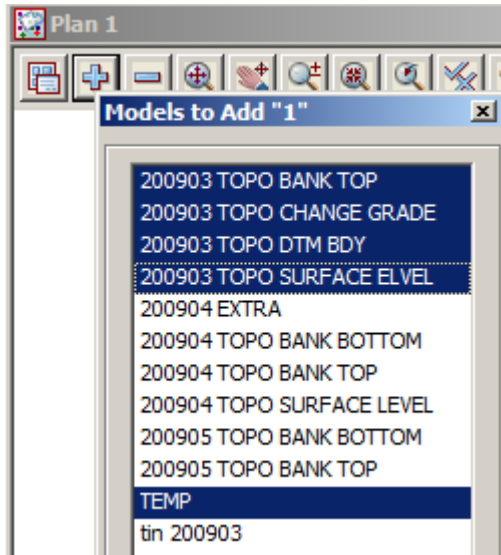

Select *Utilities=>Fence=>Multi Fence*

The screenshot shows the 'Multi Fence' dialog box with the following settings and annotations:

- Data to fence:** View is set to '1'. An arrow points to the view icon.
- Fence:** Model of fences is 'TEMP'. An arrow points to the model selection icon. The 'Exclude model containing fence' checkbox is checked. An arrow points to this checkbox.
- Results:** Model for fence inside is blank. An arrow points to the selection icon. Model for fence outside is '200904 EXTRA'. An arrow points to the selection icon.
- Buttons:** 'Fence', 'Finish', and 'Help' are visible at the bottom.

Annotations on the right side of the dialog box:

- Select view icon
- Select view 1
- Select the model **TEMP** as the model name for the paralleled excavation edges
- Tick check box to **Exclude model containing fence**
- We only want to combine the data outside the excavation edges so leave **Models for fence inside** blank
- Type in new model name **200904 EXTRA** for data outside the excavations
- Select **Fence** then **Finish** to create the data

Turn off all **200903** models
 Turn on all **200904** models including the newly created model **200904 EXTRA**

Zoom in to where one of the 200903 strings is trimmed against the fence boundary

The string is cut at the parallel string and not the top of bank ensuring there are no crossing breaklines in the subsequent tin

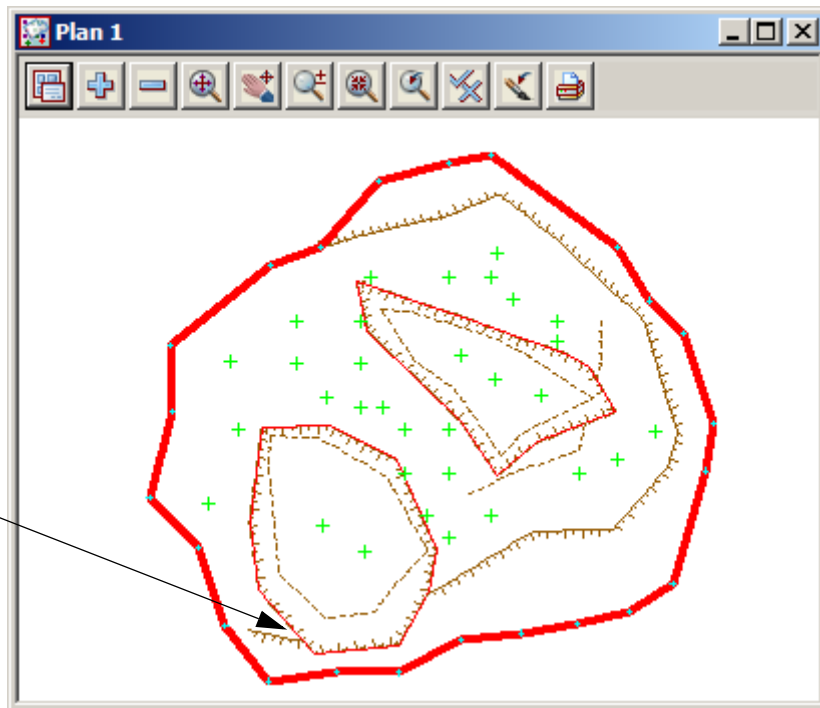

Triangulate the 200904 combined surface

Firstly turn off the model **TEMP** as it is not to be used in the tin

Select *Tins=>Create=>Triangulate data*

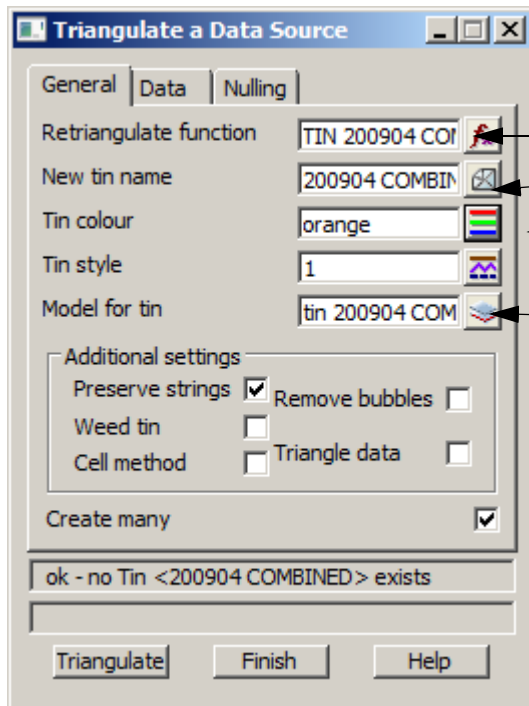

Type in the function name **TIN 200904 COMBINED**

Type in the tin name **200904 COMBINED**[Enter]

Select colour **orange** for tin

Select tin style (line type) **1**. This is a continuous line

When selecting **[Enter]** key after entering tin name the model name is automatically created with **tin** as the prefix

The only check box needed to be ticked is **Preserve strings** which will ensure breaklines are inserted at the time of triangulation

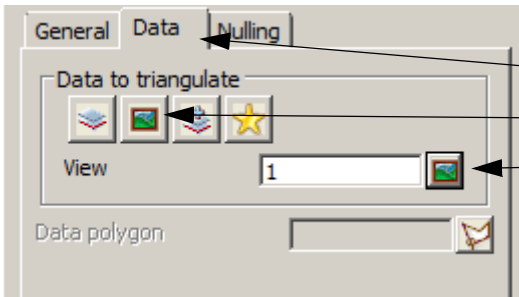

- Select the **Data** tab
- Select the view icon
- Select view **1**

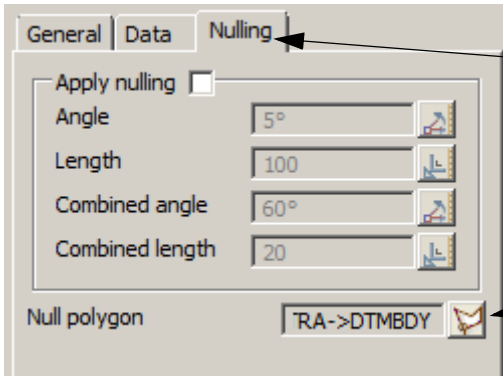

- Select the **Nulling** tab
- Select the **Null polygon** choice icon
- Pick and accept the old boundary string
- Select **Triangulate**
- Select **Finish**

Turn on the model **tin 200904 COMBINED** to view the triangulation

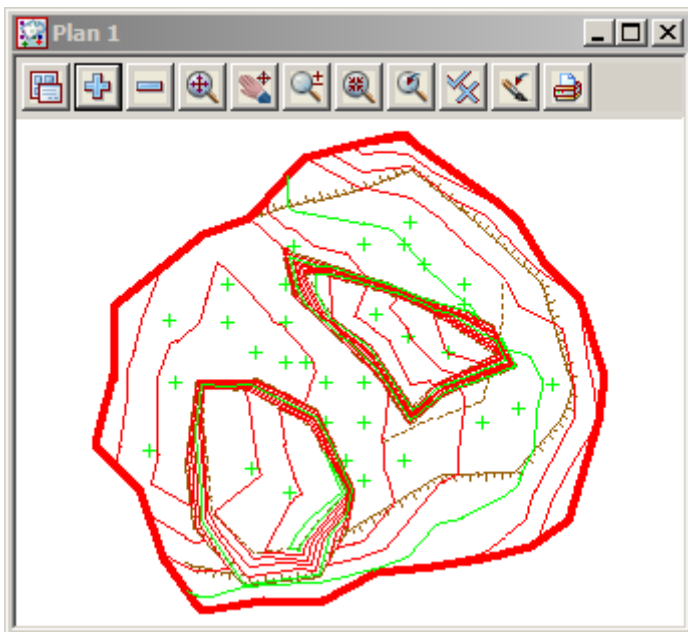

At any time we can view the updated surface in a perspective view.

Select option *View=>New=>Perspective Open GL*

Turn on the tin model **tin 200904 COMBINED** then toggle on the tin shading

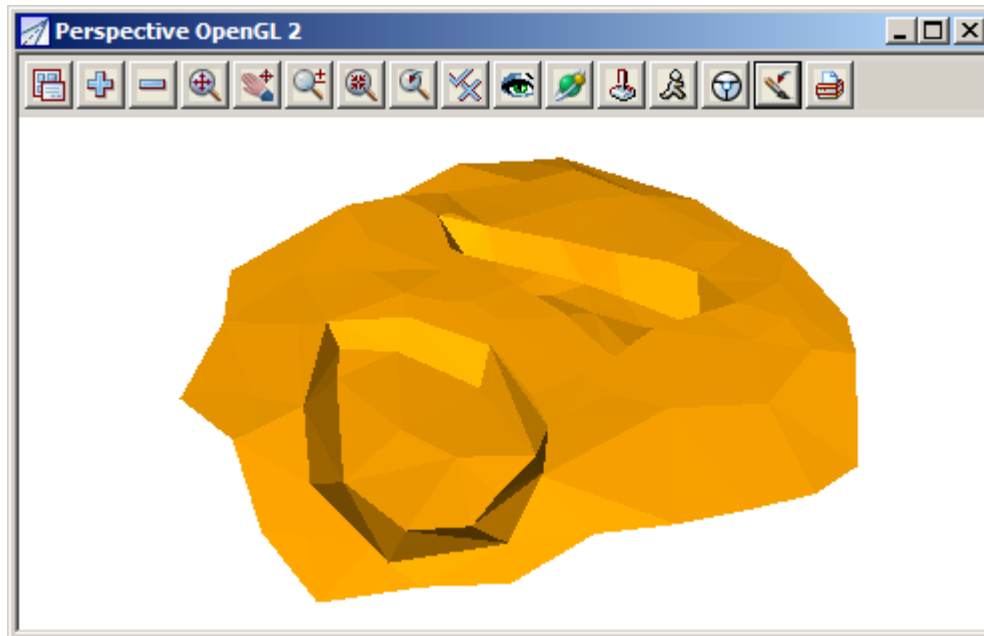

As the volumes are calculated monthly the procedure for importing and reducing the subsequent surveys is the same

10.5.5 Calculate volumes from April to May survey

We will now calculate the volumes between the combined April surface to the May survey

Firstly turn off all models then read back in the May survey. We will do this by reading in the model list previously created

Restore the May model list

Select *View=>Models Save/Restore*

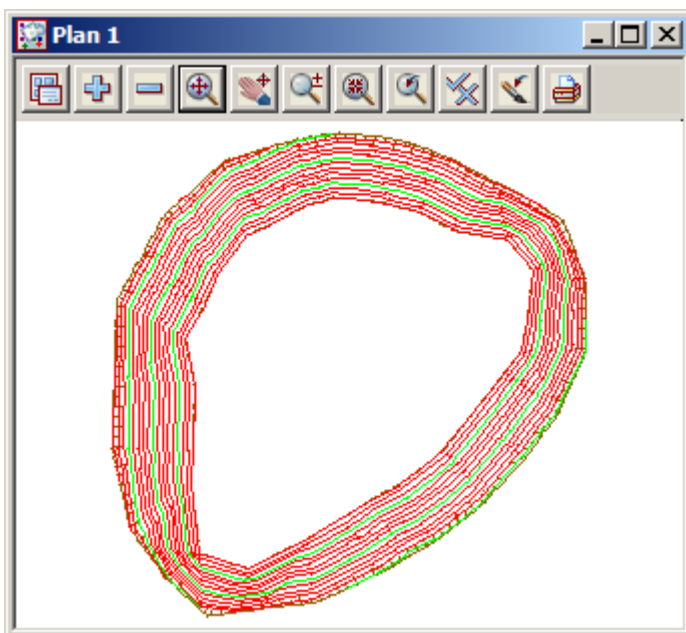
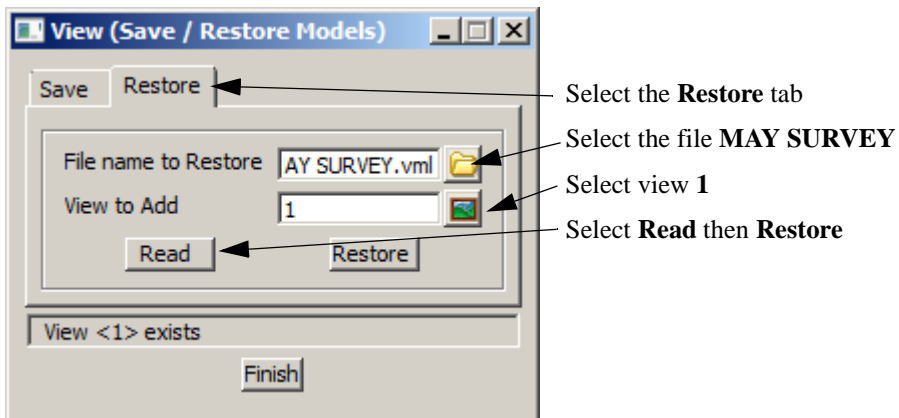

Calculate EXACT TIN TO TIN volumes

The volumes will again be done using the two methods

Select *Design=>Volumes=>Exact=>Tin to tin*

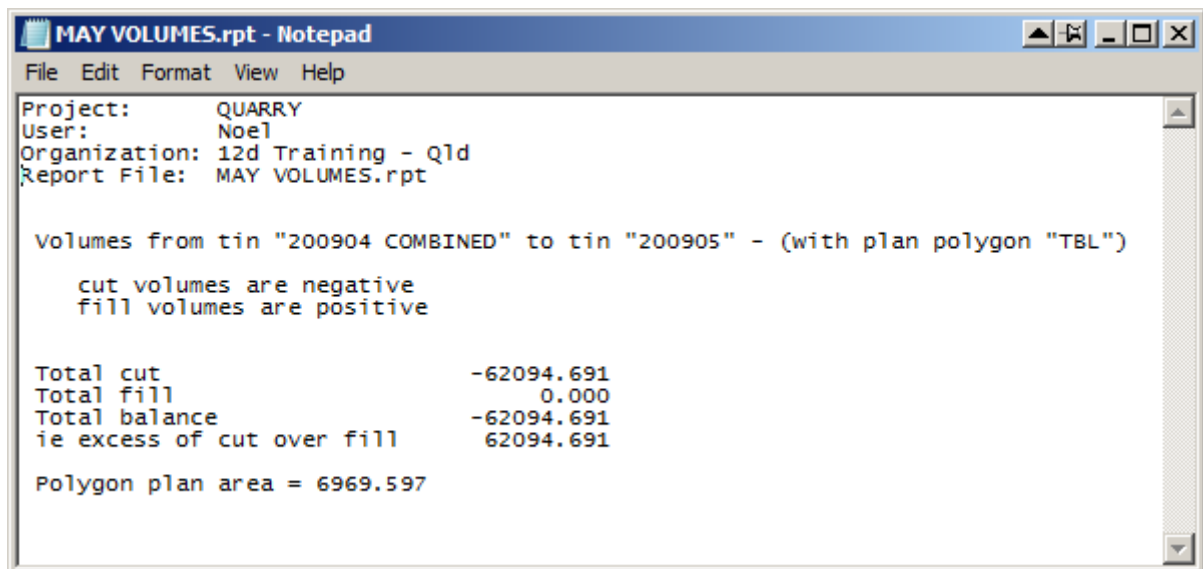
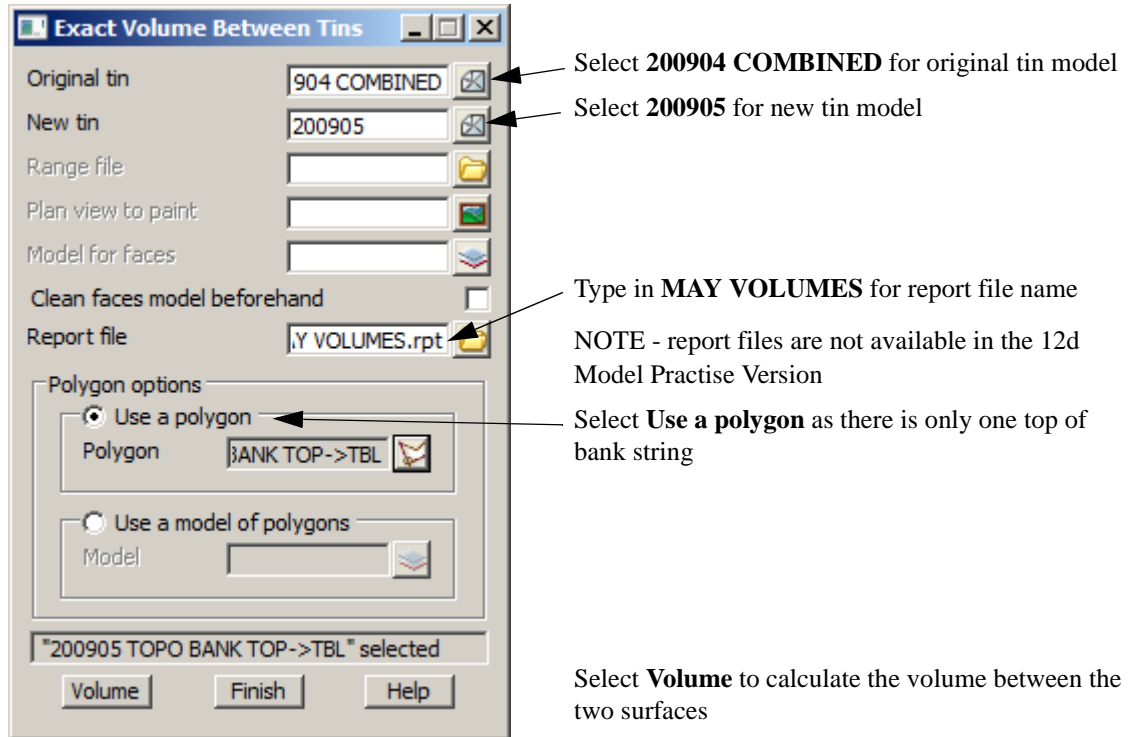

Calculate TIN TO TIN BY HEIGHT RANGE volumes

Select *Design=>Volumes=>Tin to tin ht range*

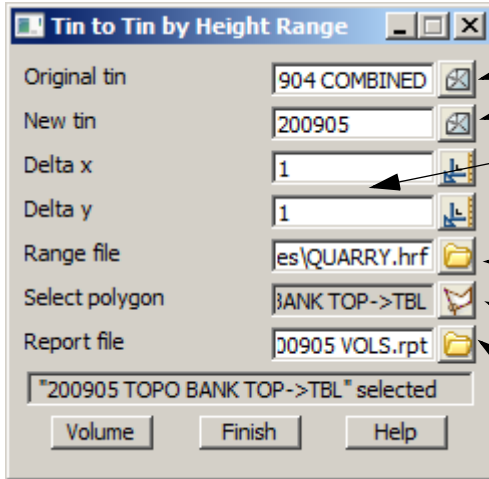

- Select **200904 COMBINED** for original tin model
- Select **200905** for new tin model
- Type in 1 for the delta x and delta y spacing
- This will calculate the volumes based on a 1 metre grid
- Browse up to the Volumes folder and select the height range file **quarry.hrf**
- As there are two excavations **do not** pick a polygon

- Select the previous report file **MAY VOLUMES** to append to
- Select **Volume** to calculate the volume between the two surfaces
- Select **Append** to add to the bottom of the previous report file
- The volume report is opened in the default text editor

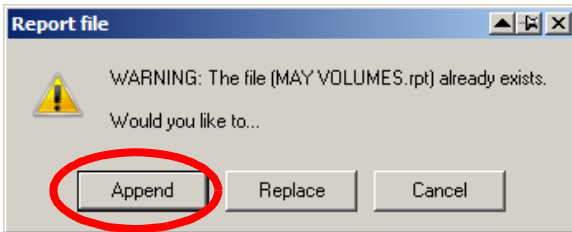

```
Project:      QUARRY
User:        Noel
Organization: 12d Training - Qld
Report File: MAY VOLUMES.rpt
```

Volumes from tin "200904 COMBINED" to tin "200905" - (with plan polygon "200905 TOPO BANK TOP->TBL")

Height		Incremental		Accumulative		Balance
1	2	Cut	Fill	Cut	Fill	
60.000	61.000	0.000	0.000	0.000	0.000	0.000
61.000	62.000	-0.000	0.000	-0.000	0.000	-0.000
62.000	63.000	-3672.111	0.000	-3672.111	0.000	-3672.111
63.000	64.000	-3890.339	0.000	-7562.450	0.000	-7562.450
64.000	65.000	-4114.015	0.000	-11676.465	0.000	-11676.465
65.000	66.000	-4319.057	0.000	-15995.521	0.000	-15995.521
66.000	67.000	-4420.374	0.000	-20415.896	0.000	-20415.896
67.000	68.000	-4458.732	0.000	-24874.627	0.000	-24874.627
68.000	69.000	-4462.048	0.000	-29336.675	0.000	-29336.675
69.000	70.000	-4566.795	0.000	-33903.470	0.000	-33903.470
70.000	71.000	-4548.098	0.000	-38451.568	0.000	-38451.568
71.000	72.000	-4374.841	0.000	-42826.409	0.000	-42826.409
72.000	73.000	-4043.504	0.000	-46869.914	0.000	-46869.914
73.000	74.000	-4030.171	0.000	-50900.085	0.000	-50900.085
74.000	75.000	-3915.805	0.000	-54815.889	0.000	-54815.889
75.000	76.000	-3200.108	0.000	-58015.997	0.000	-58015.997
76.000	77.000	-2287.335	0.000	-60303.332	0.000	-60303.332
77.000	78.000	-1452.673	0.000	-61756.005	0.000	-61756.005
78.000	79.000	-337.597	0.000	-62093.602	0.000	-62093.602
79.000	80.000	0.000	0.000	-62093.602	0.000	-62093.602

```
Total cut          -62093.602
Total fill          0.000
Total balance      -62093.602
ie excess of cut over fill  62093.602
```

Polygon plan area = 6969.597

10.5.6 Combine the April combined surface and May surfaces

We need to make a copy of the April survey that falls outside the edge of the May survey.

Parallel top of bank

Prior to creating a new parallel string we will delete the strings previously created in the TEMP model. The easiest way to do this is to clean out the model

Select option *Models=>Clean*

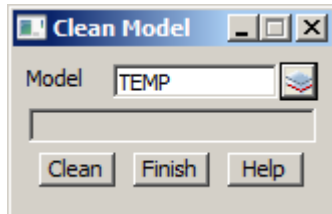

Select the model **TEMP**

Select **Clean**

Select **Yes** to confirm

Ensure the current model in the cad control is still **TEMP** then parallel the string using the option *Cad Strings=>Strings Parallel*

Pick with direction along the edge of the top of bank string

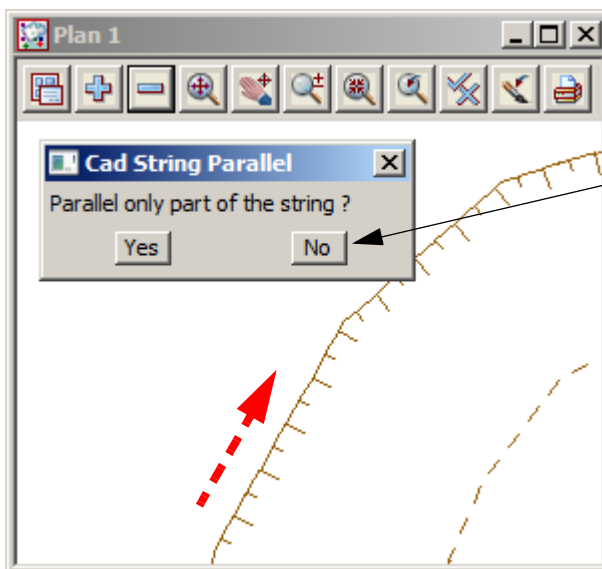

Select **No** to parallel the whole of the

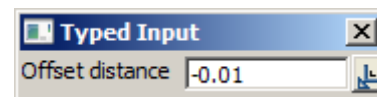

string

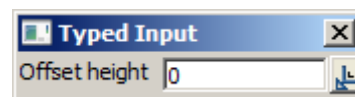

Type in **-0.01 [Enter]**

Press **[Enter]** to accept the offset

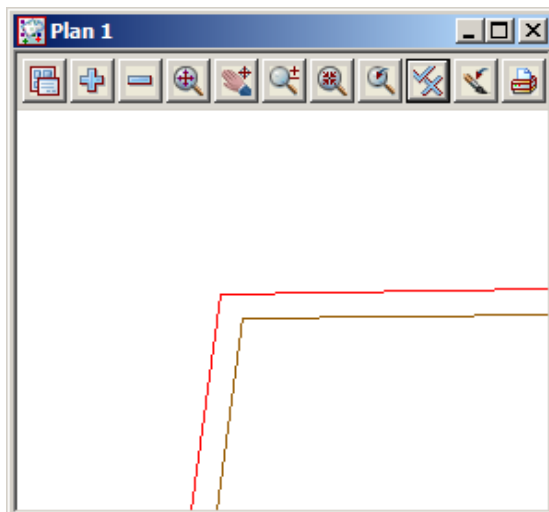

Fence the April combined survey

We will use the fencing routine to save the data outside the limit of the May survey excavations to a new model.

Turn off all models

Turn on the **20904** models along with the **TEMP** top of excavations

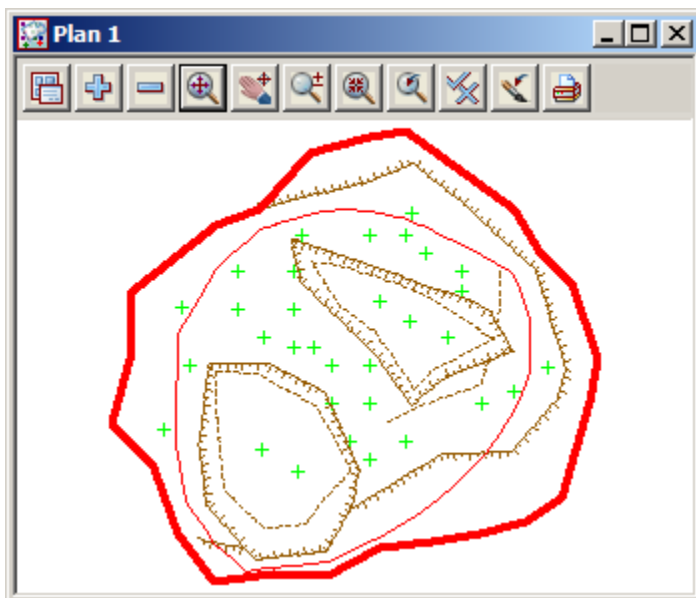
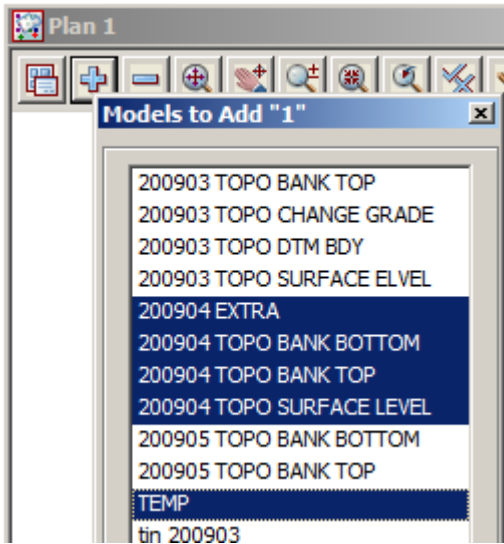

Select *Utilities=>Fence=>Fence*

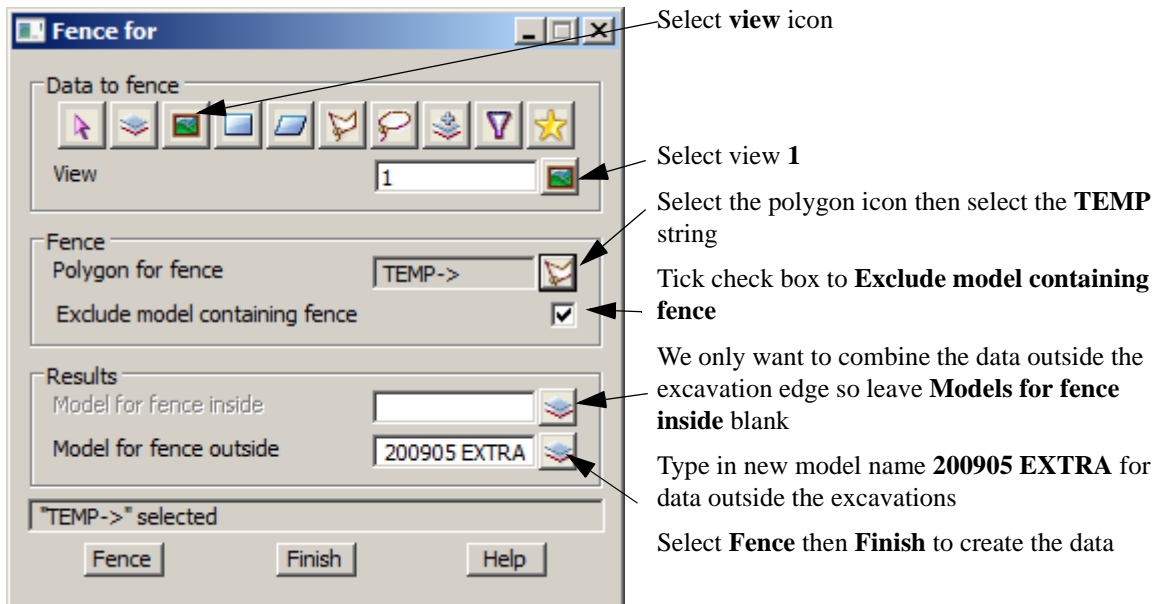

Turn off all **200904** models

Turn on all **200905** models including the newly created model **200905 EXTRA**

Also turn off the model **TEMP**

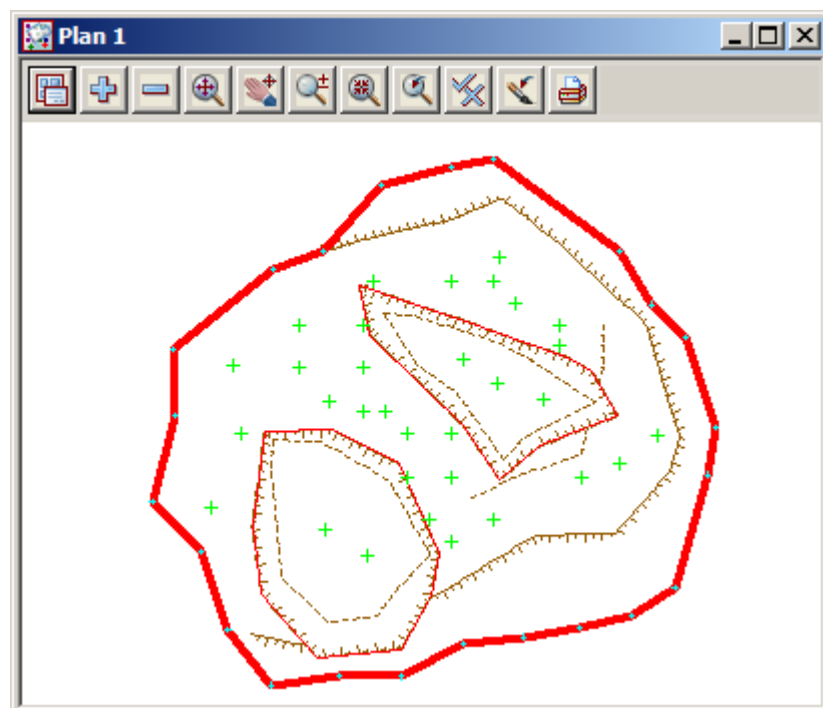

Triangulate the 200905 combined surface

Select *Tins=>Create=>Triangulate data*

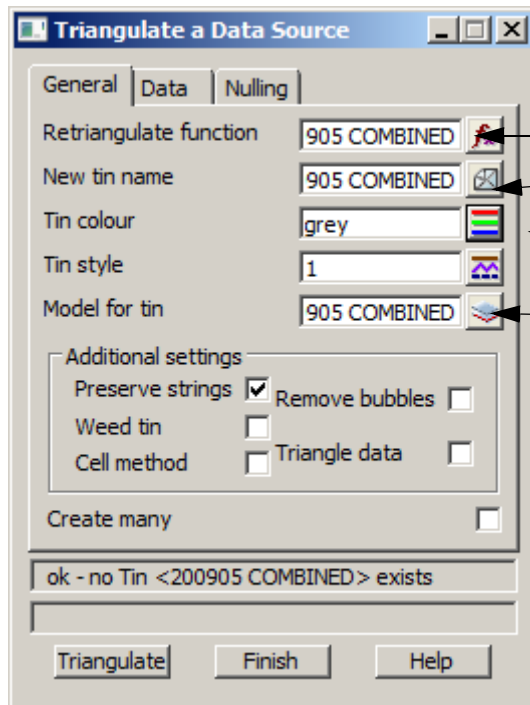

Type in the function name **TIN 200905 COMBINED**

Type in the tin name **200905 COMBINED**[Enter]

Select colour **orange** for tin

Select tin style (line type) **1**. This is a continuous line

When selecting **[Enter]** key after entering tin name the model name is automatically created with **tin** as the prefix

The only check box needed to be ticked is **Preserve strings** which will ensure breaklines are inserted at the time of triangulation

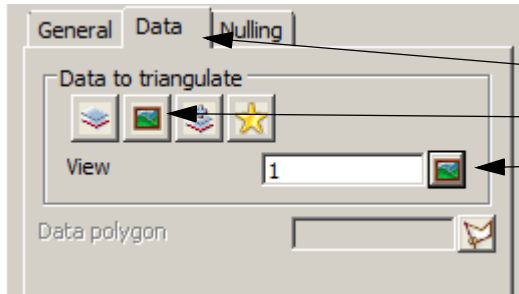

- Select the **Data** tab
- Select the view icon
- Select view **1**

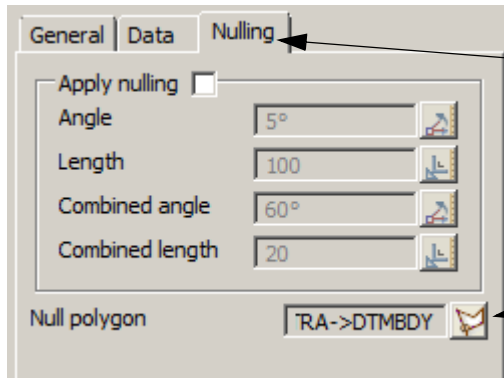

- Select the **Nulling** tab
- Select the **Null polygon** choice icon
- Pick and accept old boundary string
- Select **Triangulate**
- Select **Finish**
- Turn on the model **tin 200905 COMBINED** to view the triangulation

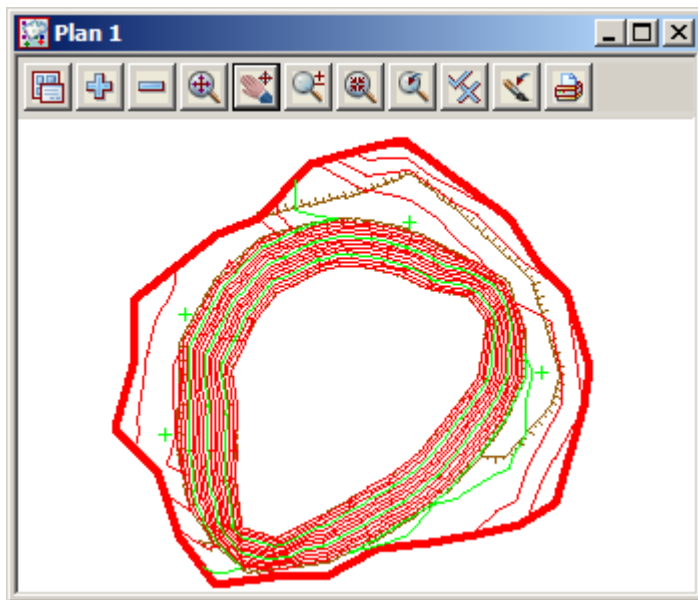

Again view the updated surface in a perspective view.

Turn off all models then turn on the tin model **tin 200905 COMBINED** then toggle on the tin shading

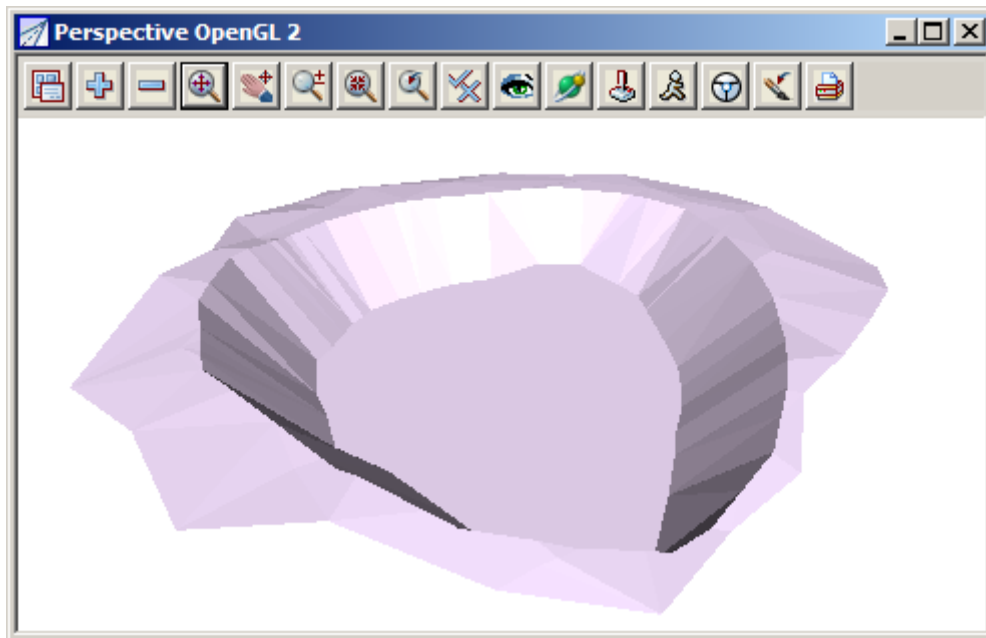

11 Setout

In this chapter we will look at various types of setout calculations where the feature is constructed in the graphics and a setout file is created for upload to a data collector. The types of setout include:

Building creation and setout

Imported building from cad file

Setout for evenly graded string

Creating 3d setout for imported 2d cad strings

Road setout from imported strings

Triangulation setout

QA Reporting of point, string and tin setout

11.1 Building setout

In this topic we will create a lot outline and position a building on the lot for setout.

To begin create a new project called **HOUSE SETOUT** in the Survey training area

First, double click on the *12d Model 9* icon to bring up the **Project Selection** panel.

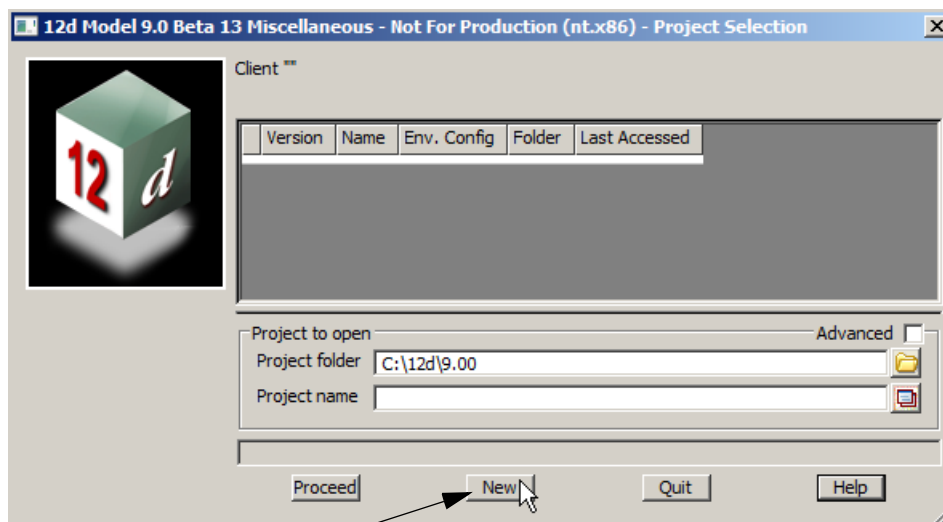
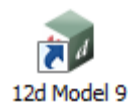

Select **New** button to bring up the **New project** panel.

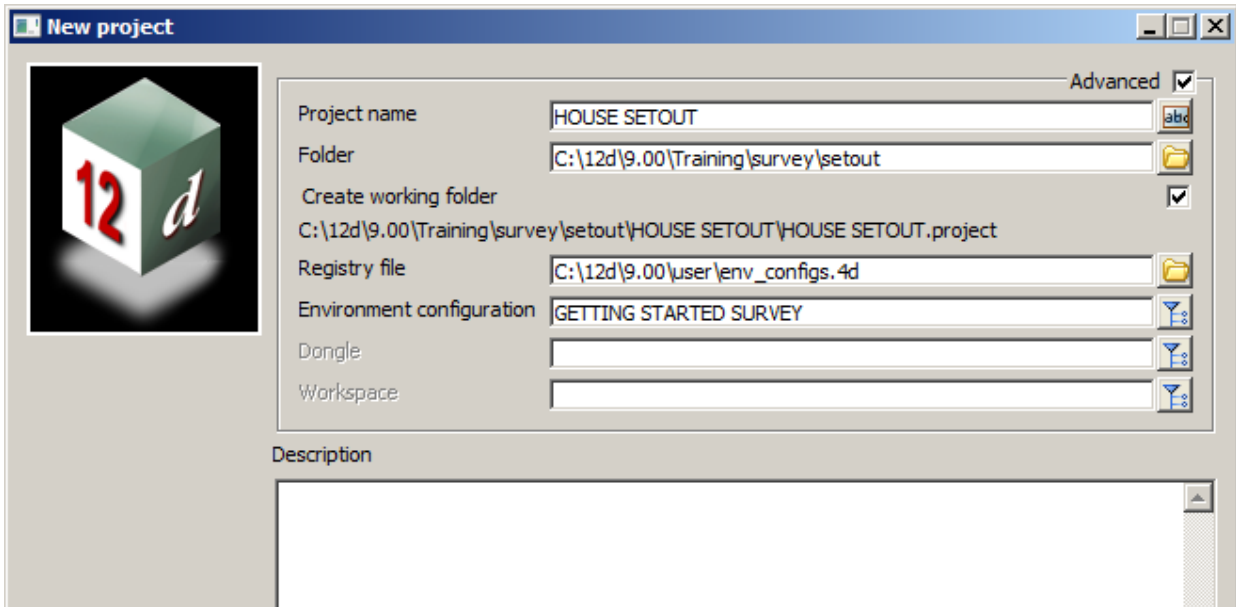

Create a project under the folder **C:\12d\9.00\Training\survey\setout** called **HOUSE SETOUT**

With the *Create working folder* check box ticked a working folder with the same name as the project will be also created

Select the Environment configuration **Configurations=>GETTING STARTED SURVEY** which is the one we set up in the previous chapters. If you have gone straight to this chapter you will have to follow the steps in chapter 9.2 to edit the Registry file

Select [**Create**] to create and open the project

Screen Setup

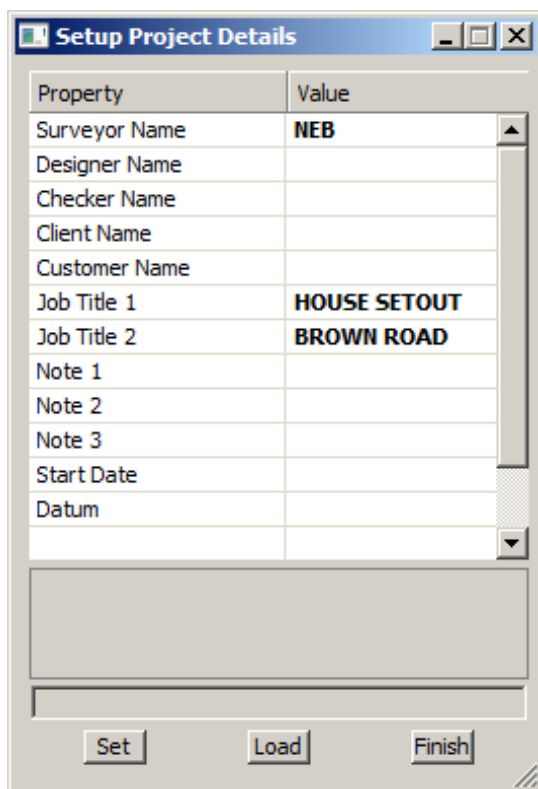

When the project starts up for the first time the **Project Details** panel appears

The information typed in here can be used when plotting from this project

Fill in the various prompts if necessary

Select **Set** then **Finish** to save the settings and continue

11.1.1 Create the lot outline

The lot outline will be created in a model called **LOT**

Type in the name and model name **LOT** in the **CAD controlbar**. Select the colour **Red**



Select option *Strings=>Cad=>Lines=>Traverse Create*
or **Traverse** icon

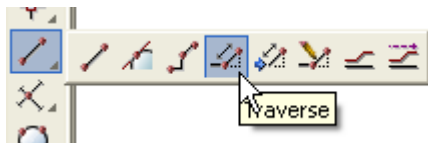

Press the **Space** bar to activate the **coordinate entry** panel

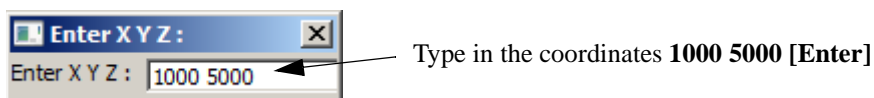

Press the **Space** bar to activate the **bearing input** panel

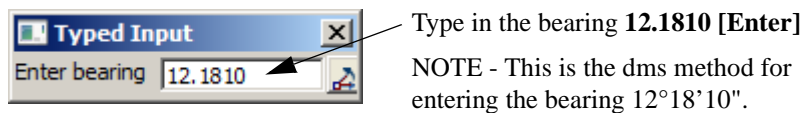

Press the **Space** bar to activate the **distance input** panel

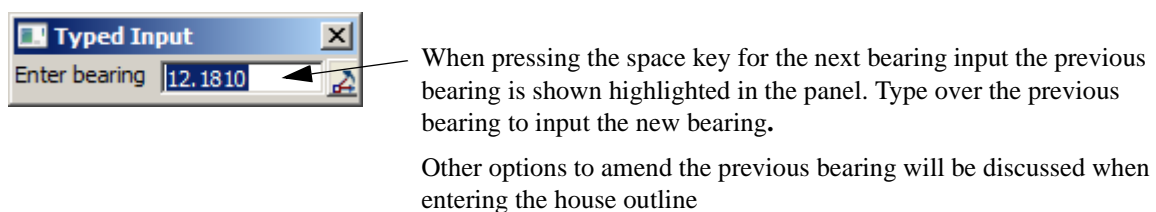

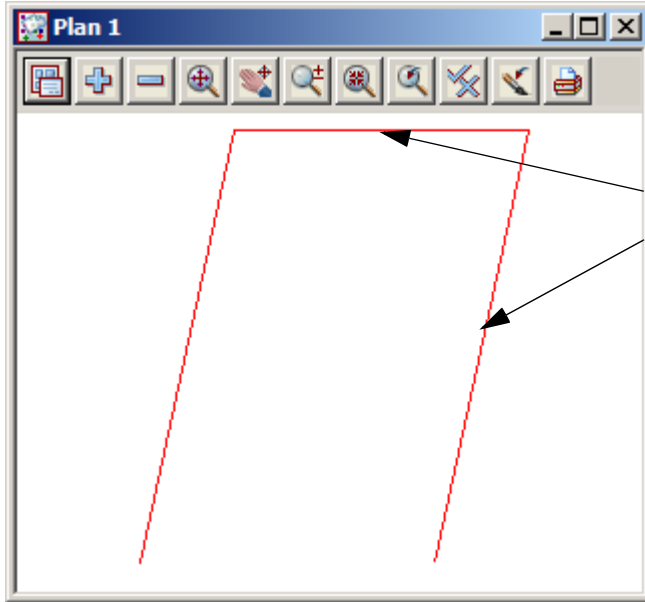

Repeat the entry of bearing and distance using the following dimensions

90°00'00" 23.870

192°18'10" 35.818

192°18'10" is entered as 192.1810.
Remember to input the trailing zeroes.

After typing this line press [Esc] to exit option

Check the misclose of the last line by selecting option *Utilities=>Measure=>Bearing/Distance* or **Measure Bearing/Distance** icon

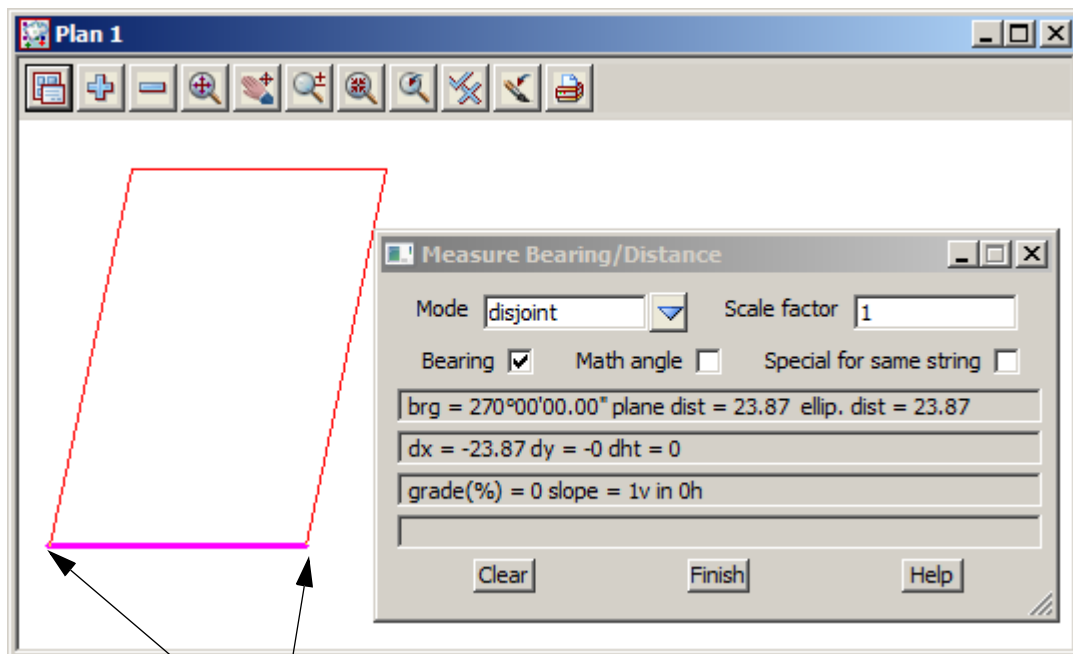
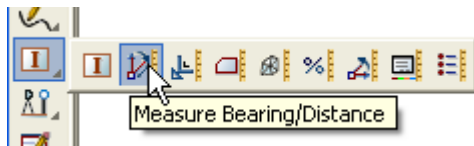

Select and accept the start and end points of the lot traverse

The bearing and distance between the two points is displayed

If correct, close the string by using option *Strings=>Cad=>Change strings=>Close*

or select **String Close** icon

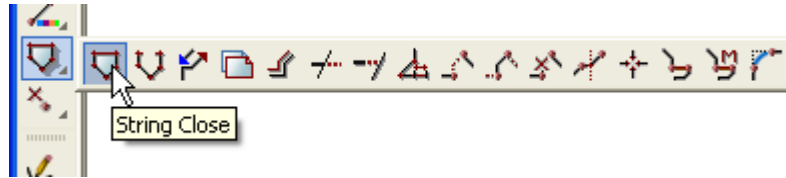

From this point in the manual we will be using the cad icons only. The menu options are available under the option *Strings=>Cad*

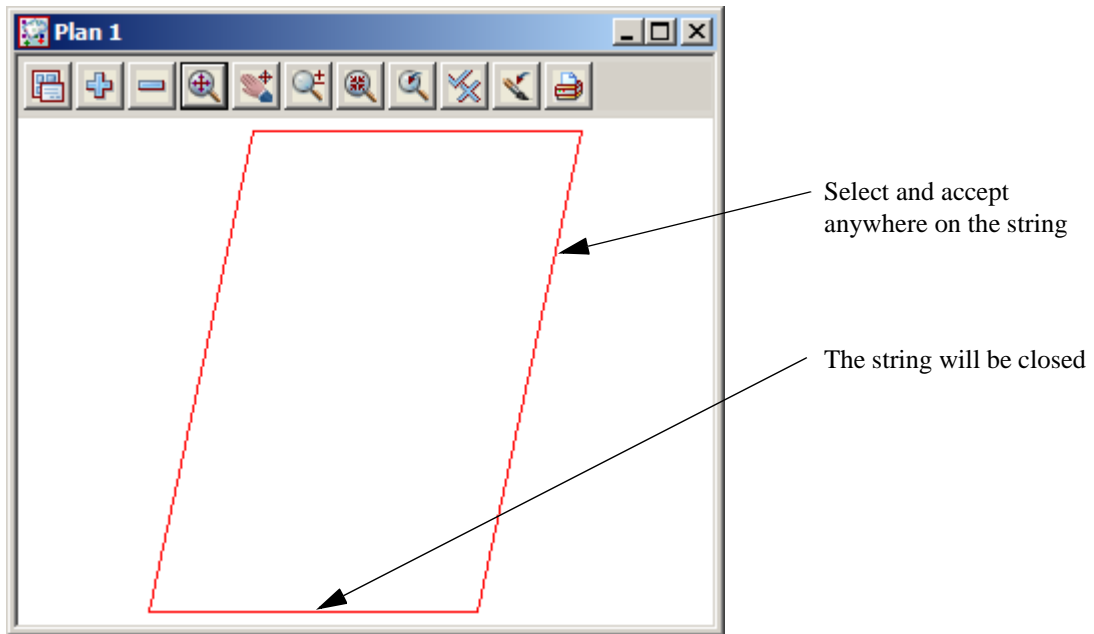

11.1.2 Create building outline

In this option we will create the outline of the building using the previous traverse routine and explore some other traverse editing features

Type in the name and model name as **HOUSE** in the **CAD controlbar**. Select the colour **blue**

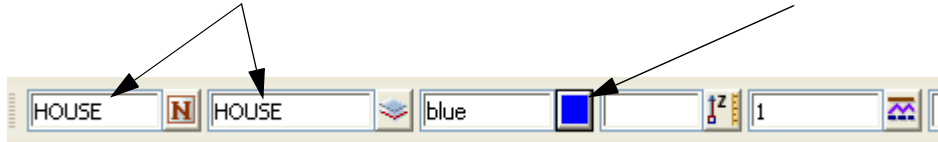

Select option **Traverse** icon

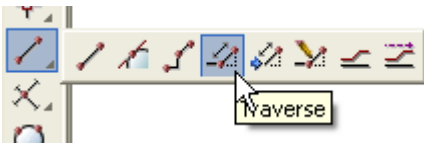

We are going to start the house corner 7.0 metres up from the lower left corner of the lot and offset 1.8 metres in from the side boundary

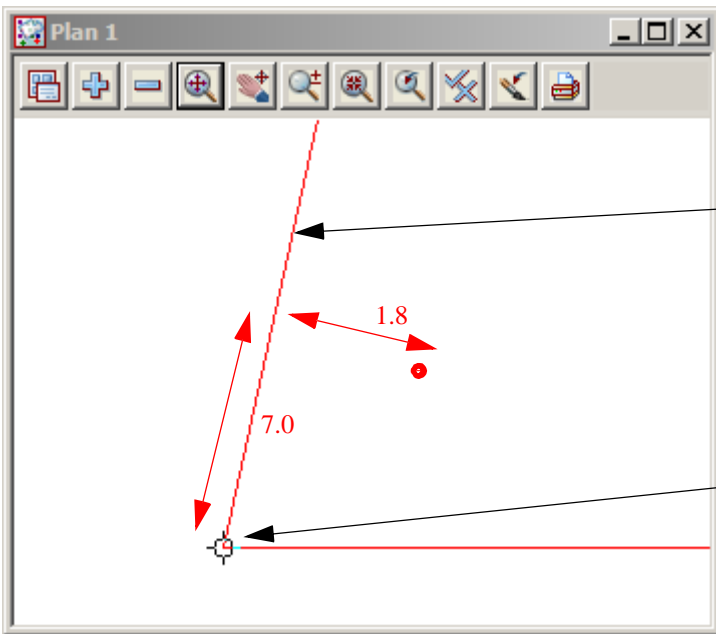

Prior to picking the start point select the **Snaps offset** icon from the snaps toolbar

Select the left boundary with direction dragging towards the top

Select the bottom left corner of the lot as the control point. This will be the point where the measurement is taken from

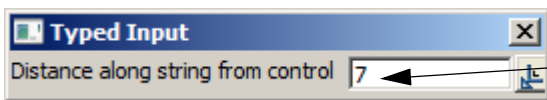
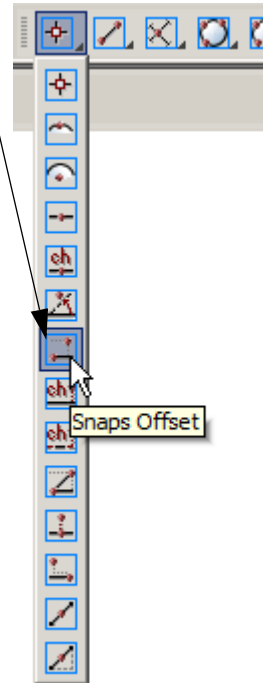

Type in the distance **7 [Enter]**

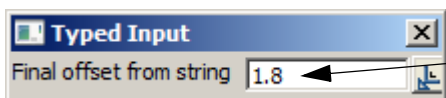

Type in the offset **1.8 [Enter]**

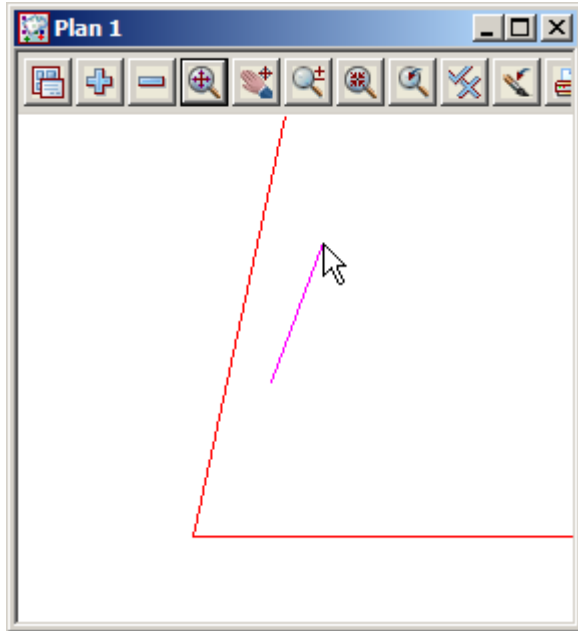

The point is created in a model called **constructions snap data** and automatically turned off.

The end of the string now locks to the cursor position

Press the **Space** bar to activate the **bearing input** panel

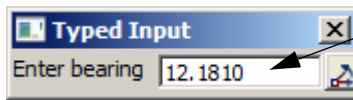

Type in the bearing **12.1810** [Enter]

Press the **Space** bar to activate the **distance input** panel

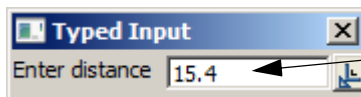

Type in the distance **15.40** [Enter]

We will now look at some options to speed up the traversing process.

For the next bearing we are going to traverse at right angle to the previous bearing

Press the **Space** bar to activate the **bearing input** panel

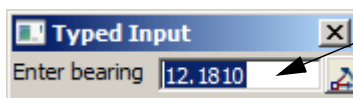

The previous bearing appears. Press [**Page Up**] to add 90 degrees to the bearing (We could have pressed [**Page Down**] to subtract 90 degrees).

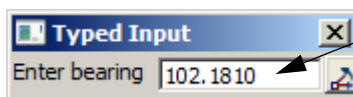

Press [Enter] to confirm the bearing

Press the **Space** bar to activate the **distance input** panel

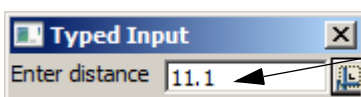

Type in the distance **11.1** [Enter]

For the next bearing we will traverse tangential to the left boundary line

At the bottom of the screen there are a number of options that can be activated by selecting the letter following the option

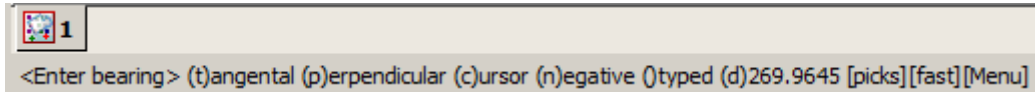

To traverse tangential select **[T]** from the keyboard then pick the left boundary line

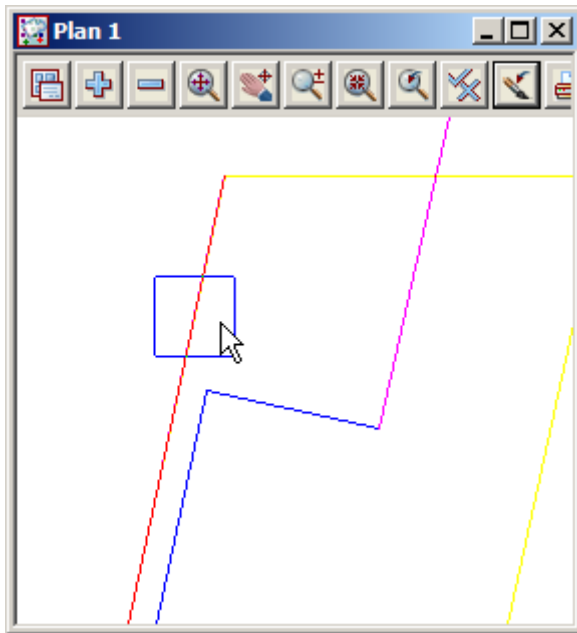

The proposed direction is highlighted. This may be in the opposite direction to that required so simply select **[N]** to reverse the direction line if necessary.

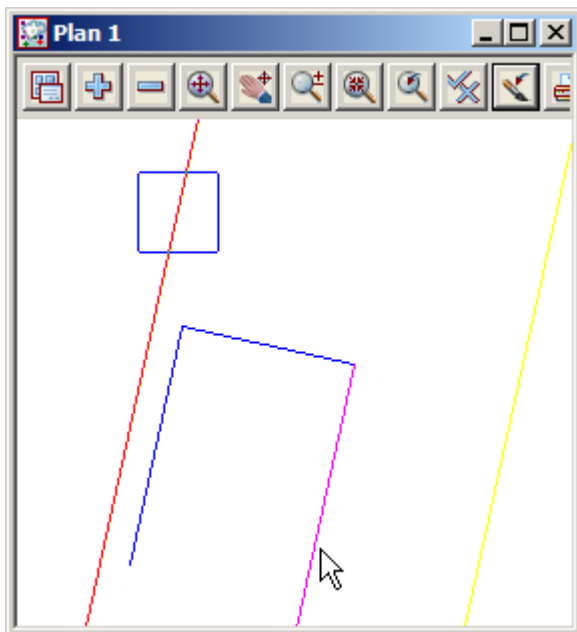

Press middle button or select **[Enter]** to confirm the direction

Sometimes an error occurs when entering the traverse so the traverse has to be stopped and restarted.

Press **[Escape]** to exit the traverse or click right button then select Cancel from panel

Select option **Traverse Append** icon



Pick and accept the end of the house string

The traverse can continue

The remaining lines are:

Bearing **192.1810** (or tangential to left boundary) Distance **3.0**

Bearing **102.1810** (or [Page Down] after last bearing) Distance **6.0**

Bearing **192.1810** (or [Page Up] after last bearing) Distance **5.0**

Bearing **282.1810** (or [Page Up] after last bearing) Distance **8.2**

Bearing **192.1810** (or [Page Down] after last bearing) Distance **7.6**

Press [Escape]

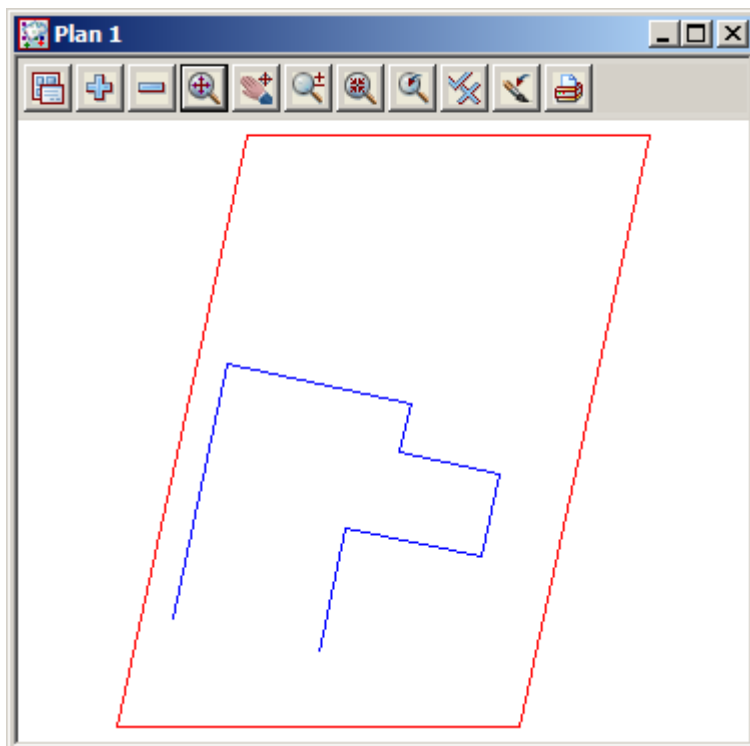

The last line has an incorrect distance and this can be edited using the following
Select option **Traverse Edit** icon



Pick and accept the last traverse line

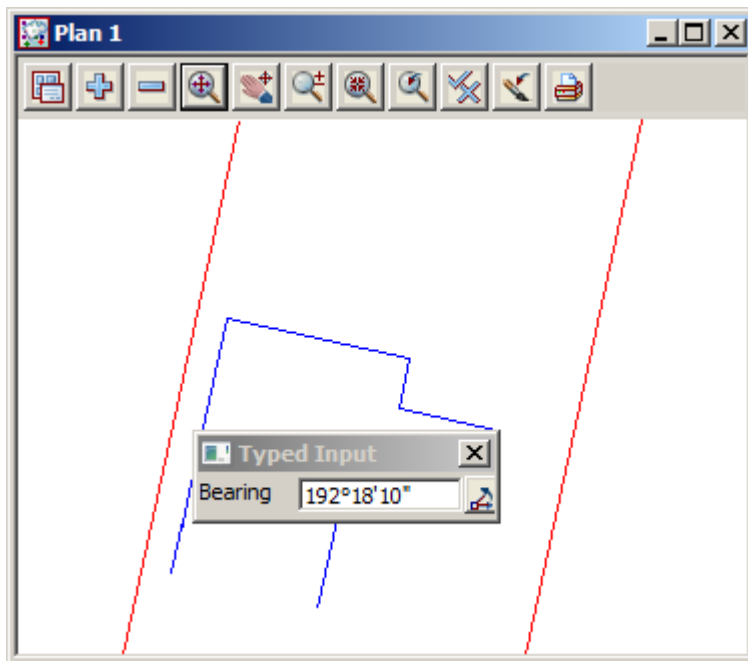

The bearing is displayed. As the error is in the distance press **[Enter]** to accept the bearing

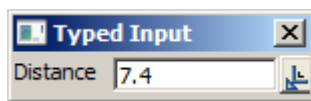

Type in **7.4 [Enter]** for the corrected distance

We can now check the misclose of the house by selecting **Measure Bearing/Distance** icon

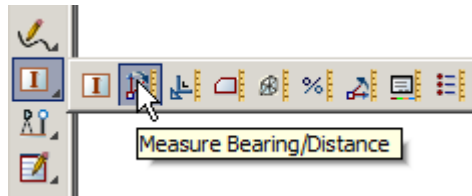

Select and accept the start and end points of the house traverse

The bearing and distance are displayed

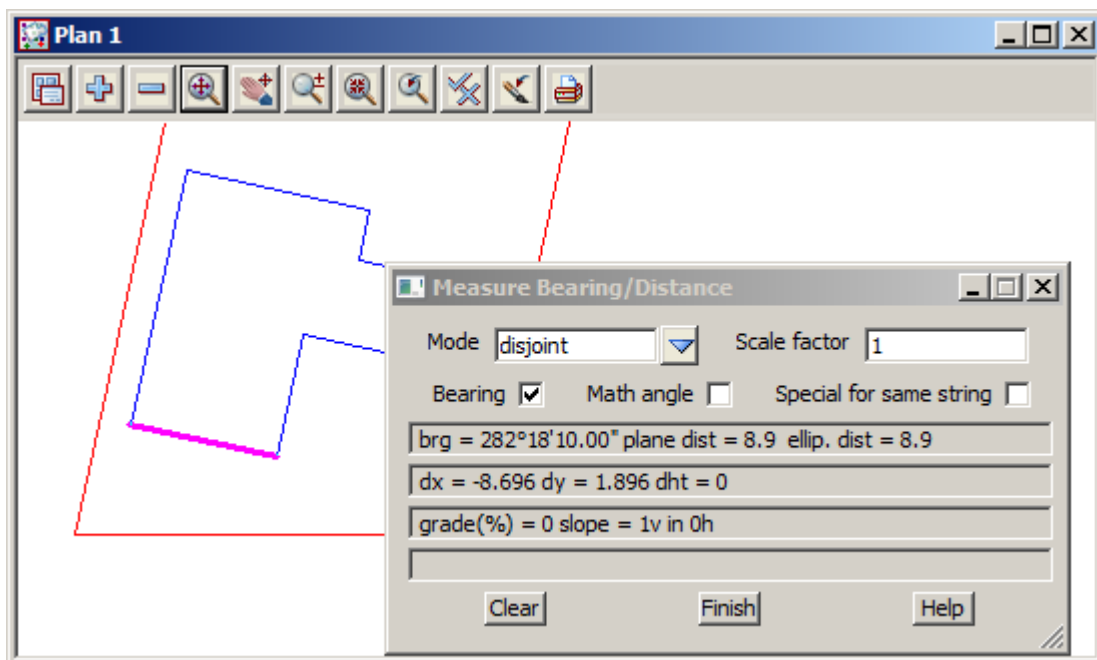

If correct, close the string by using the **String Close** icon as done previously on the lot string



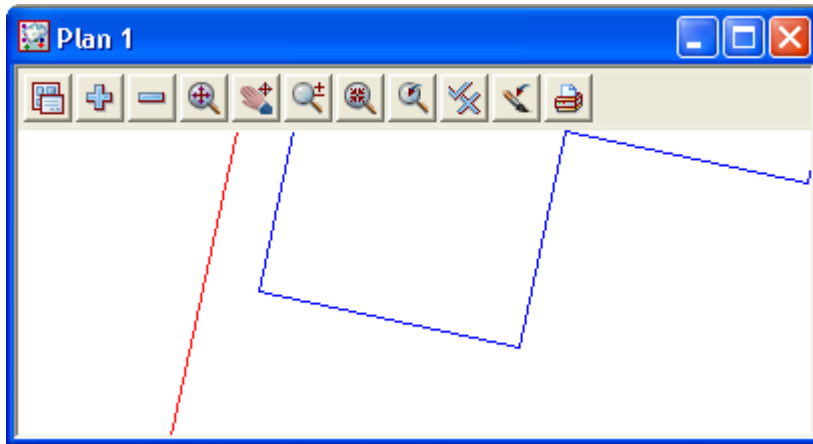

We can now check offsets from the boundaries to the building corners. To ensure the offsets are from the selected segment only, we turn on the segment snap

Turn on the segment snap

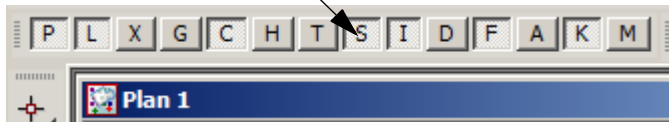

Zoom in to the left side of the building

Select the **Measure Value** icon

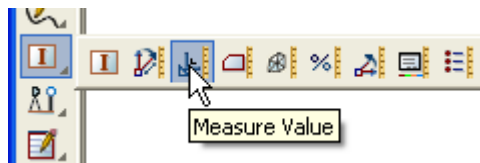

Walk right on **String to Point=>Length**

Select and accept the left boundary line

Select and accept the front left corner of the house

The offset distance is displayed

Value: 1.8

Measures:
 At Point
 Point to Point
 String from Point
 String to Point
 Length
 Length (3d)
 DX
 DY
 DZ
 Chainage
 Angle
 Vertical angle
 Bearing
 X-fall %
 Slope 1v in

11.1.3 Create dimensioned offset lines from house corners to boundaries

In this topic we will use an option to create the offset line and annotate the lines

Firstly we will use a name in the cad control bar to set the model, colour, linestyle and text for the offset lines and dimension text

Select the **Name** icon then select **.TEXT OFFSET 1 200**

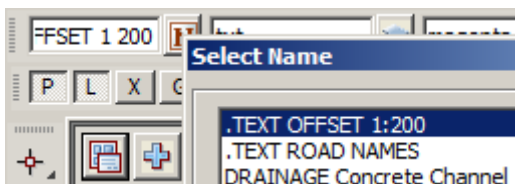

The rest of the cad control bar is populated from the settings associated with the name

We will now create the dimensioned offset lines

Select the **Label Perpendicular Offset** cad icon



Pick and accept the boundary string. Pick and accept the house corner.

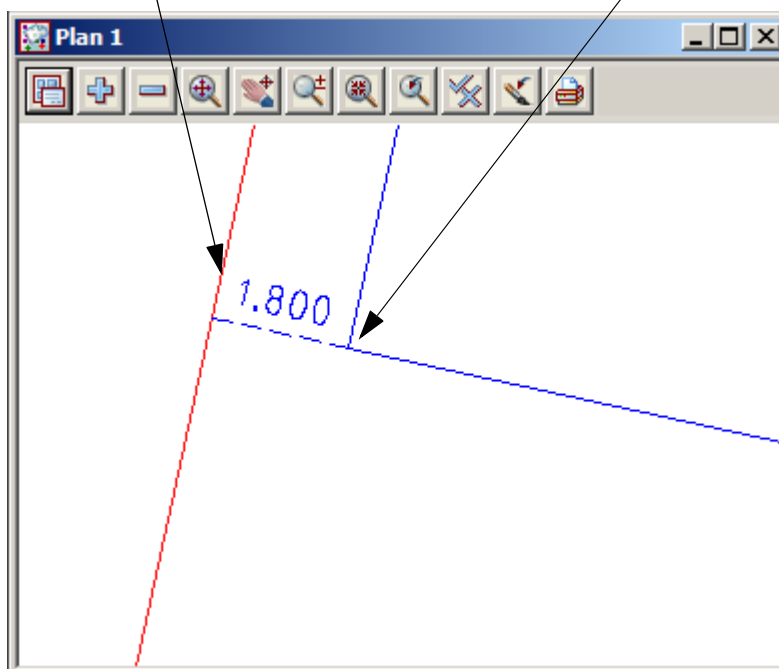

Repeat for all corners

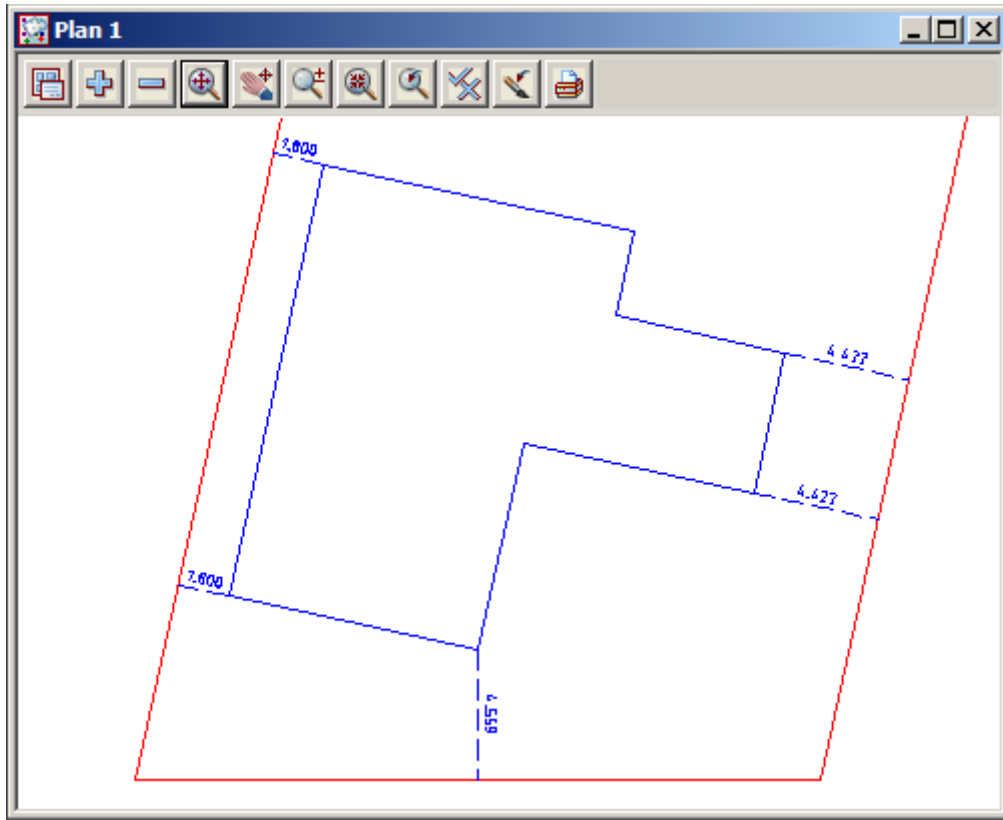

11.1.4 Create dimensions for lot and building lines

We will add bearing and distances to the lot edges and distances only to the building edges

Lot dimensions

Select option *Drafting=>Bearing/Distance labelling (2)*

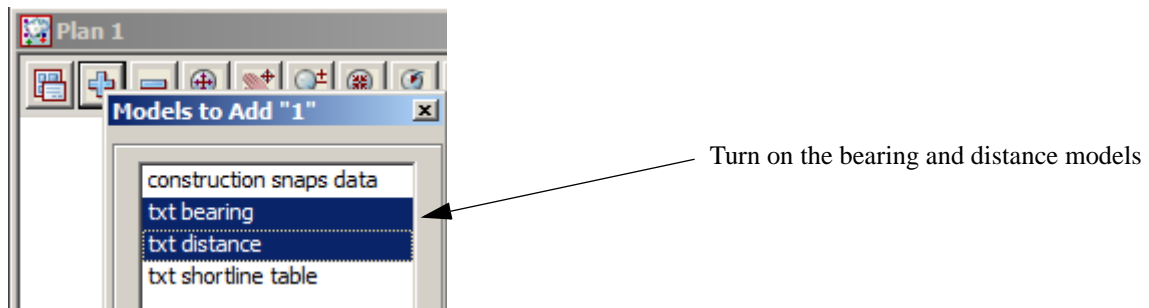
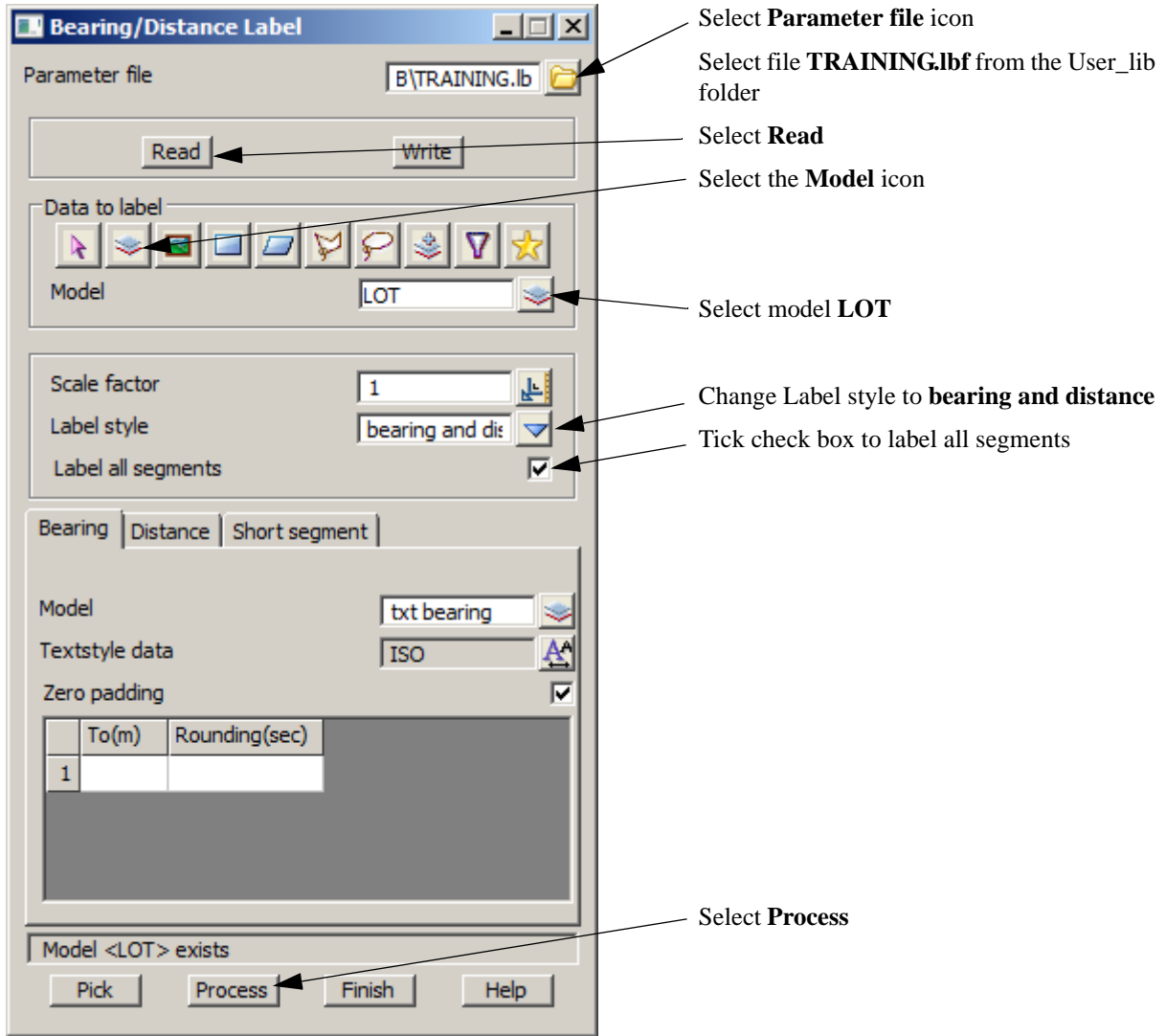

The text is displayed at a default scale of **1:1000**.

To change the scale to **1:200**

Select **Menu** icon

Walk right on **Settings** then select **Plotting scale**

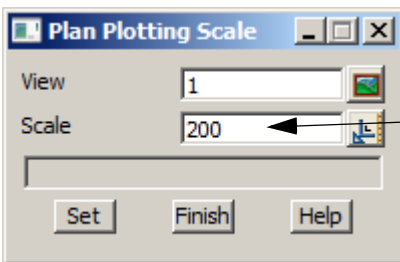
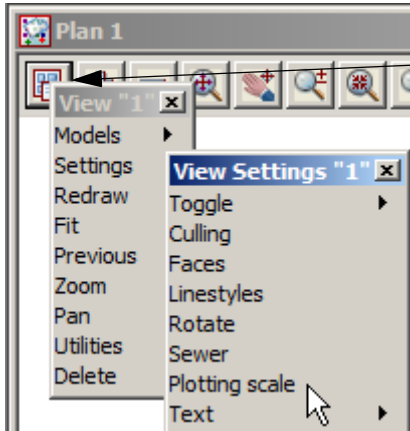

Type in scale **200** then select **Set**

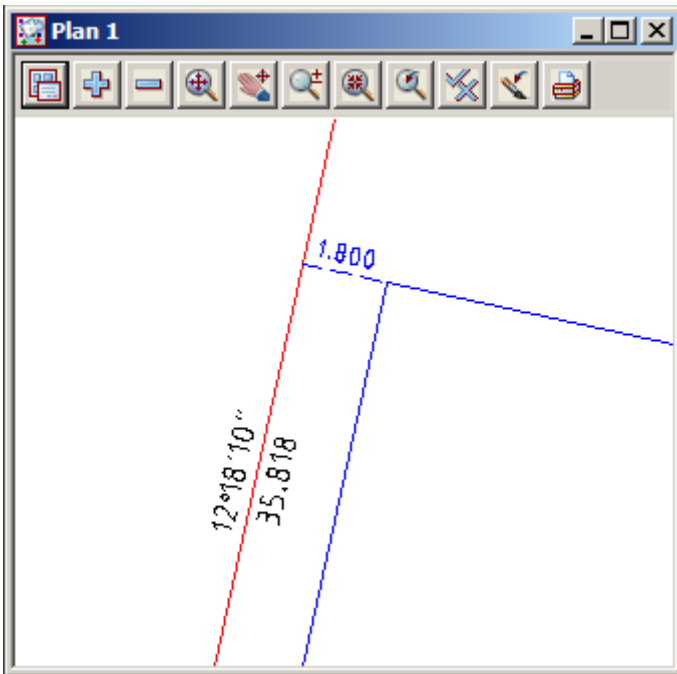

The bearing and distances which were in paper units are now at the same scale as the offset text which are in world units

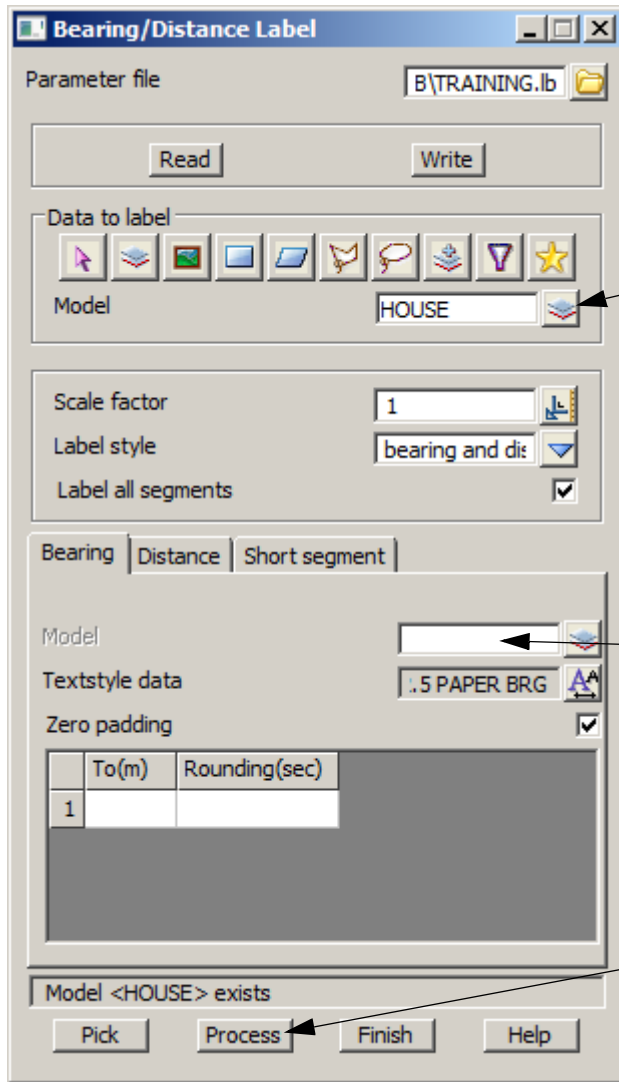

To annotate the house outline
Change the model to **HOUSE**

Delete the Bearing model name in the **Bearing** tab

Select **Process**

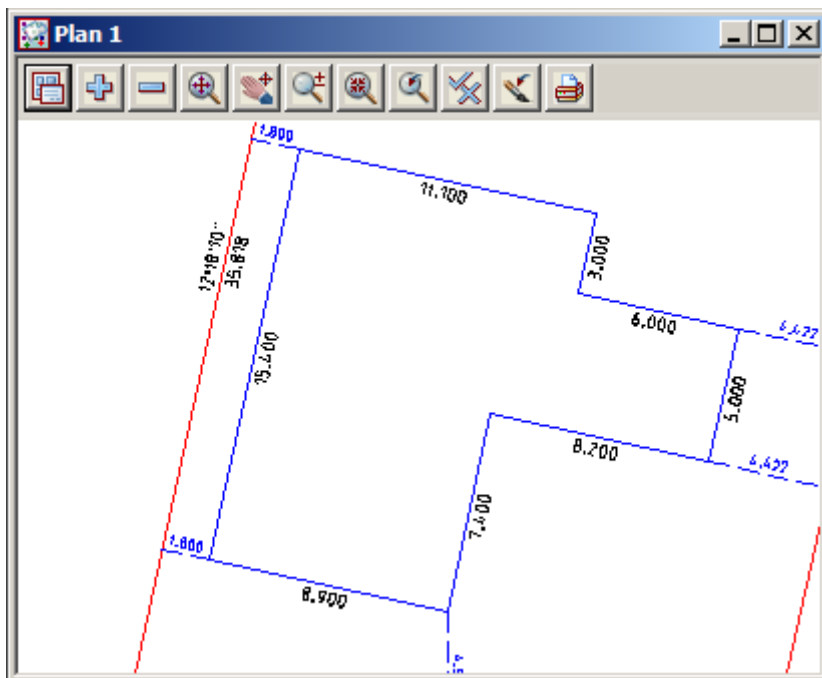

11.1.5 Setout points

Up until now the strings created around the lot boundary and building do not have point numbers
 We will now generate point numbers for the vertices for the building and lot boundaries

Turn off all models except for **HOUSE** and **LOT**

Select option *Survey=>Setout=>Setout point using super string*

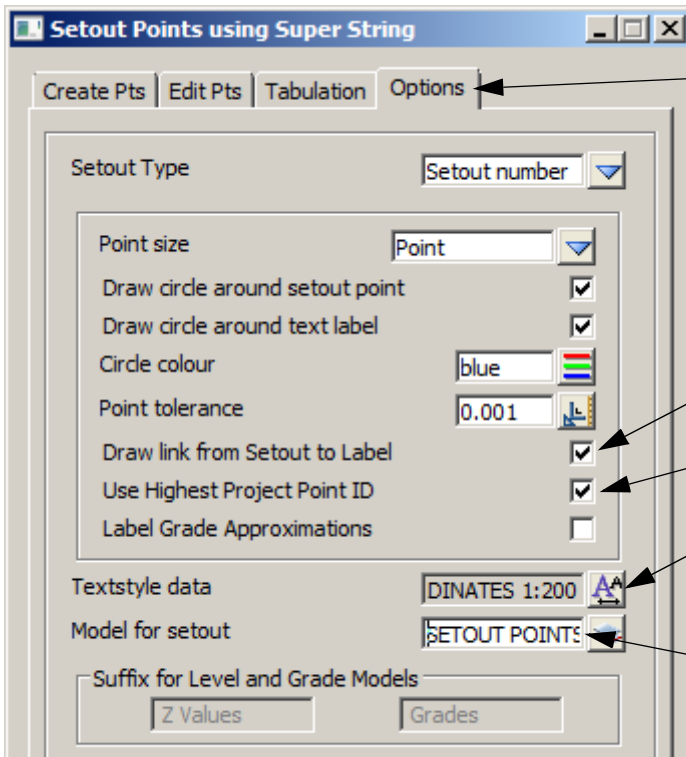

- Select the **Options** tab
- Prior to running the option we will set up some parameters
- Tick the check box to **Draw link from Setout to label**
- Tick the check box to **Use Highest Project Vertex ID**
- Select the **Textstyle data** icon and select **CO-ORDINATES 1:200**. This will ensure the text is the right height for a 1:200 plot
- Type in model **SETOUT POINTS**

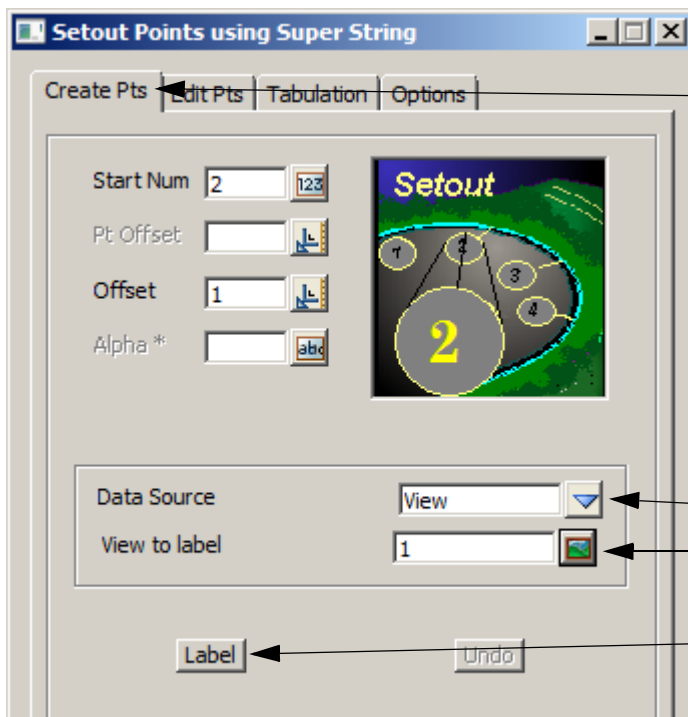

- Select the **Create Pts** tab
- Set **Data source** to **View**
- Select view **1**
- Select **Label**

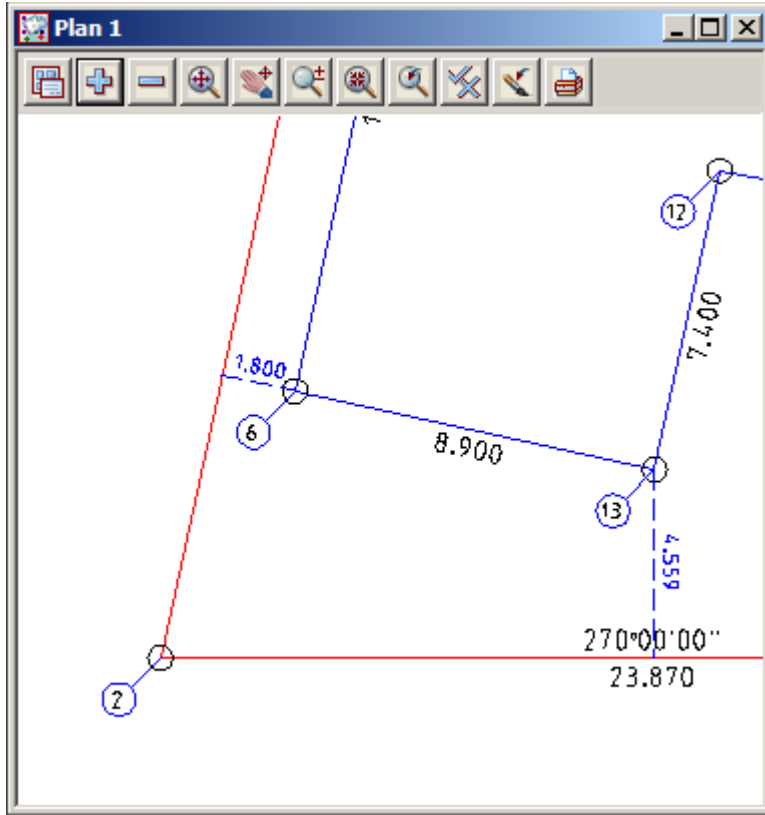

Turn on all of the models except for **construction snaps data**

To move the point numbers from overlapping other text

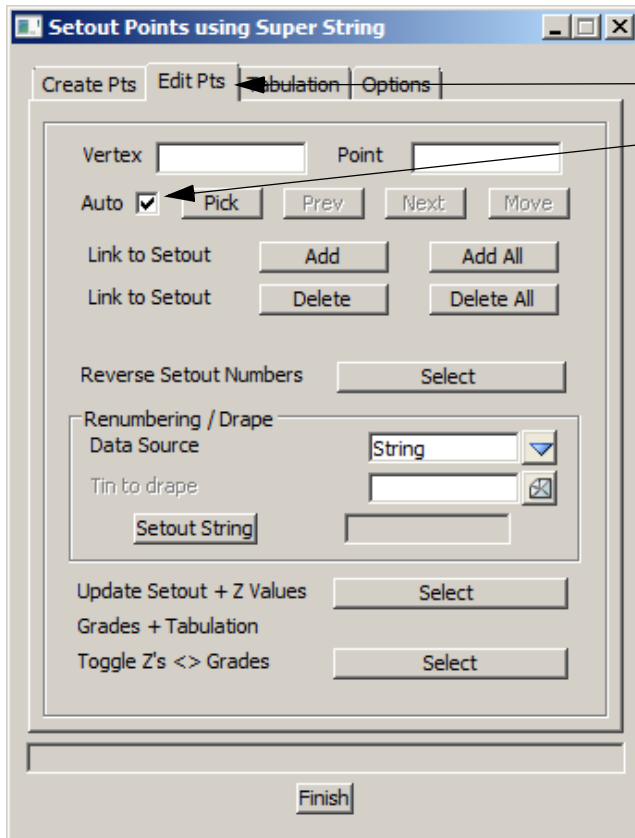

Select the **Edit Pts** tab

Tick the Auto check box

Pick and accept the circle at the corner point where the point number text is linked. Usually it requires two picks to highlight the circle.

The circled text along with the leader moves with the cursor. Select a new position

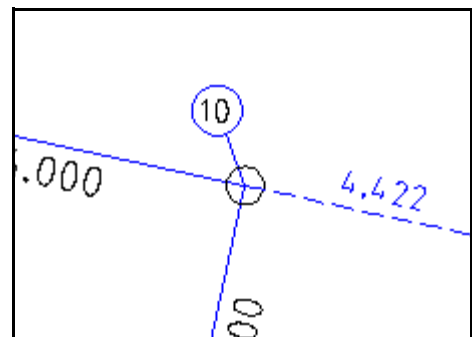

Any or all of the numbers can be moved in this to make the text readable

11.1.6 Create upload file

To create the upload file

Select option *Survey=>Upload=>Create points upload file*

The screenshot shows the 'Create Instrument Points Upload File' dialog box. It contains several sections: 'Instrument choices' with a dropdown menu set to 'Topcon GTS-700'; a list of checkboxes for 'Output Z values', 'Create new job on SDR33', 'Add + last character of code', 'Left justify fields', and 'Output feature codes'; 'User definable terminator' and 'Default char for blank name' text boxes; a 'Data source of setout points' section with a row of icons and a 'Model' dropdown set to 'SETOUT POINTS'; input fields for 'Number of decimal places' (3), 'Default for null value' (-9999), 'Start point number' (1), and 'End point number' (13); 'Origin x' and 'Origin y' text boxes; an 'Upload file' text box containing 'SETOUT.gts7'; and a 'choice ok' section with three buttons: 'Get Point Range', 'Write File', and 'Finish'. Arrows point from text annotations to these specific elements.

- Select the data collector type
- Select the **Model** icon
- Select model **Setout**
- Select **Get Point Range** to calculate point range
- The start and end point are displayed
- Change the start point to a number other than **0**. Zero was calculated as the end of the leaders are in the model **SETOUT POINTS**
- Type in the file name **SETOUT**
- Select **Write File** to create file
- Select **Finish**

11.1.7 Uploading file to data collector

The upload file can now be transferred to the data collector in a number of ways

We will look at uploading a file to the Leica Data collector

To upload to a data collector firstly select the data collector type

Select *Survey=>Setup*

or **Data Collector setup** icon

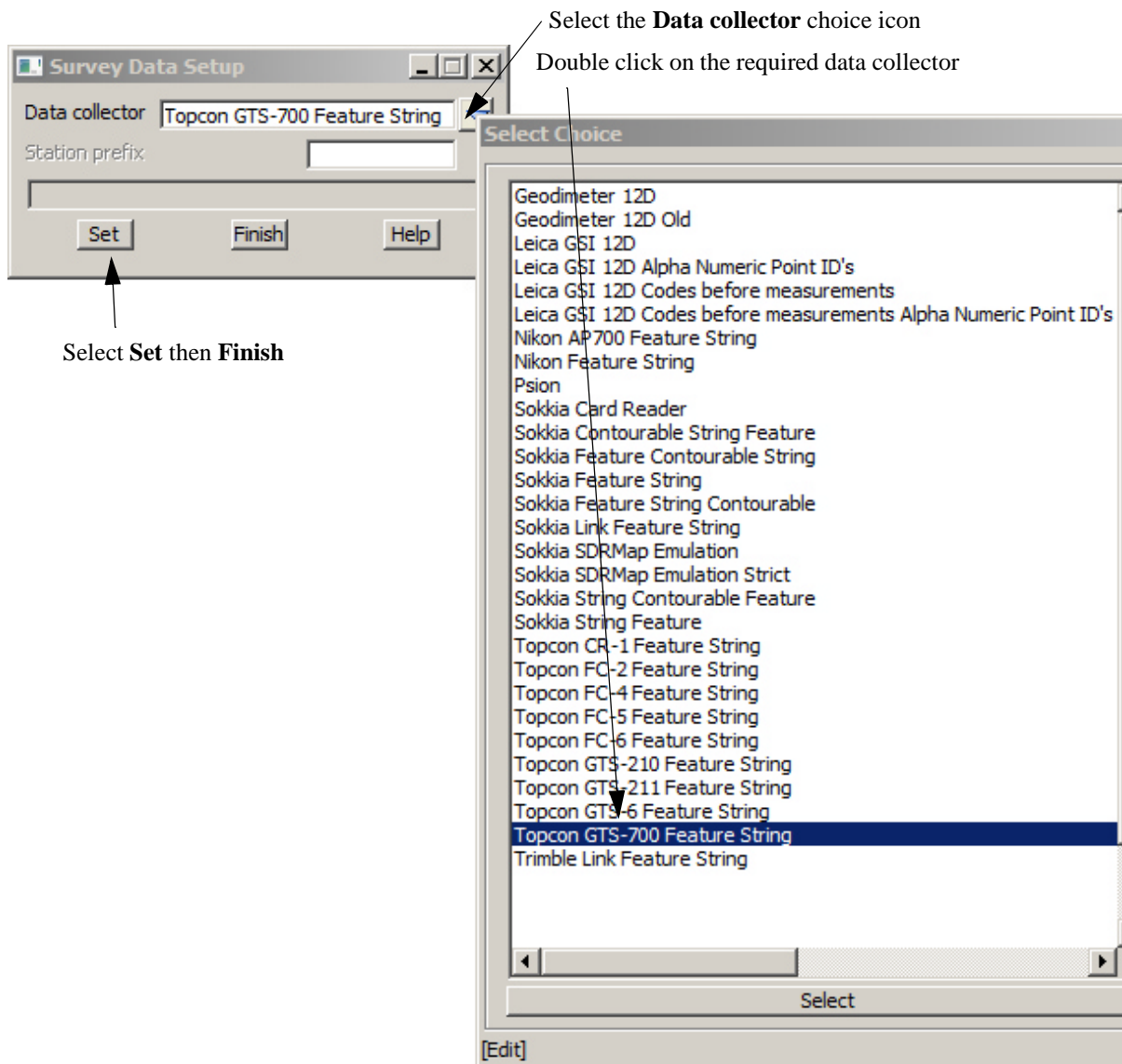
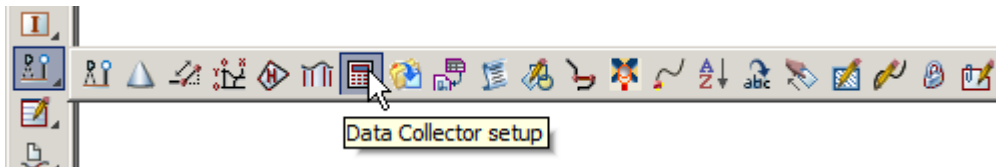

To upload the file select **Survey=>Upload=>Upload**

NOTE - You need a data collector connected to proceed.

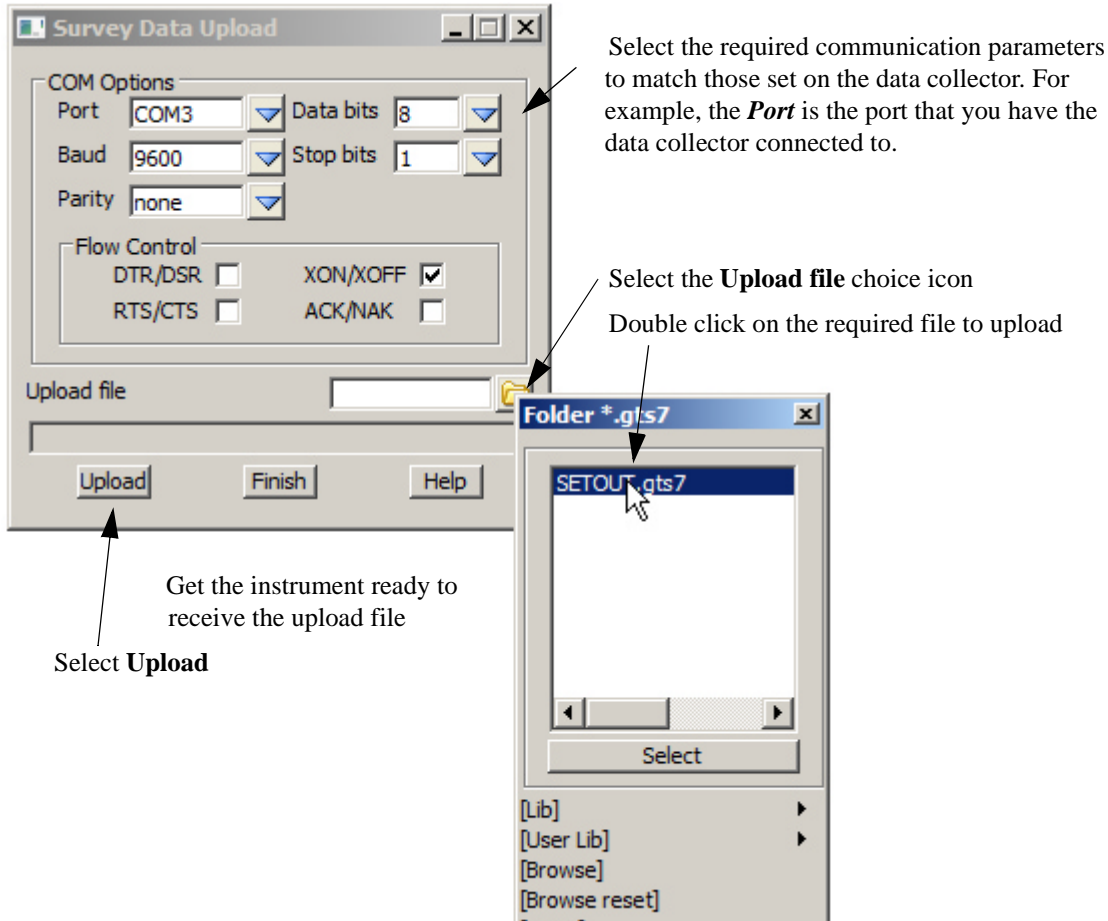

The data being uploaded will be displayed on the screen

When all data has been transferred select **Finish**

11.2 Importing house file

Share lot from previous project

In this example we will import a house file created in a cad package and saved as a dwg file. So we will use the previous project to share the **LOT** model. Prior to creating a new project the relevant model has to be flagged as being available for sharing in the source project. In the source project select

Models=>Share=>Share

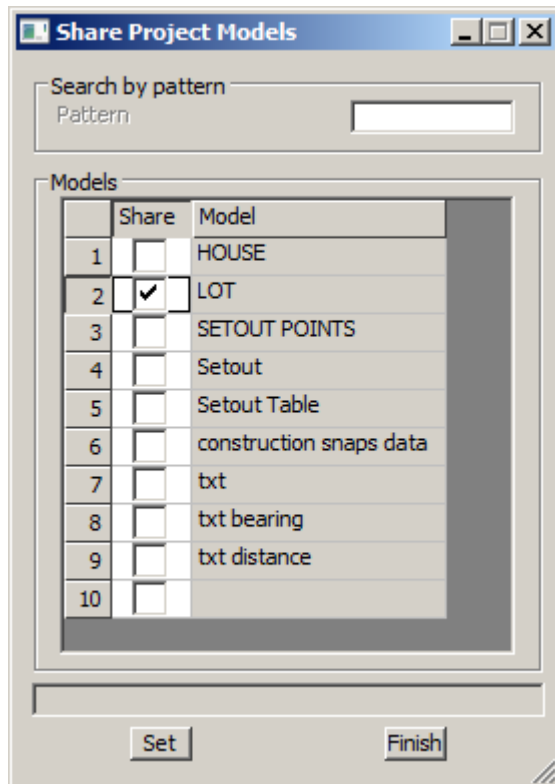

Tick the **Share** check box for model **LOT**

Tick the **Share** check box for model **LOT**

Select **Set** then **Finish**

Create new project

Create a new project as shown previously called **CAD HOUSE SETOUT** in the folder

C:\12djobs\8.00\Training\Survey\Setout\CAD HOUSE SETOUT

Remember to select the configuration **GETTING STARTED SURVEY**

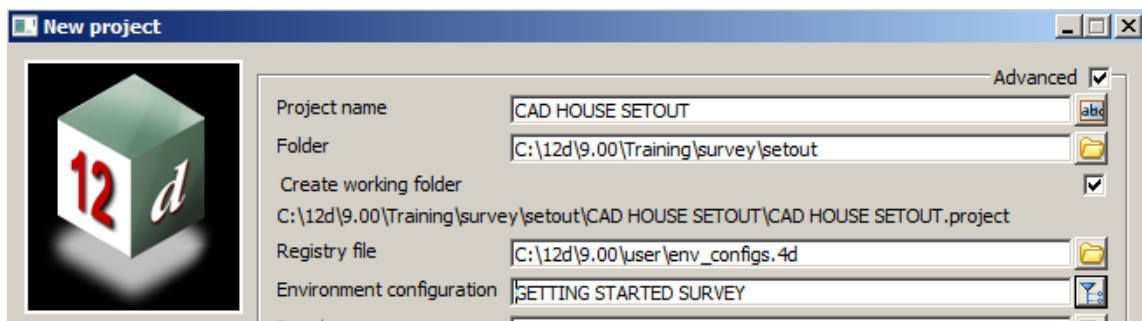

11.2.1 Share the lot outline from the previous project

Select option **Models=>Sharing=>Add**

The screenshot shows the 'Add Shared Models to Project' dialog box. The 'Folder' field contains 'C:\12d\9.00\Training\survey\setout\HOUSE SETOUT' and the 'Project' field contains 'HOUSE SETOUT'. Below these fields is a 'Search/Replace' section with 'Match sub strings' checked, and radio buttons for 'Pattern expression' (selected) and 'Regular expression'. At the bottom is a table with columns 'Add', 'Original Model Name', 'New Model Name', and 'Status'. The first row has a checked box in the 'Add' column and 'LOT' in the 'Original Model Name' column. Below the table, a status bar says 'Project <HOUSE SETOUT> exists'. At the bottom are buttons for 'Add', 'Refresh', 'Finish', and 'Help'. Annotations with arrows point to the folder icon, the project name, the 'Add' checkbox, and the 'Add' button.

Browse to the folder
C:\12d\9.00\Training\survey\setout\HOUSE SETOUT

Select **HOUSE SETOUT**

Tick under **Add** column next to model **LOT**

Select **Add** to share the **LOT** model

	Add	Original Model Name	New Model Name	Status
1	<input checked="" type="checkbox"/>	LOT		
2	<input type="checkbox"/>			

The model is referenced to the project

Turn on the model **LOT**

Note that shared models have blue model names

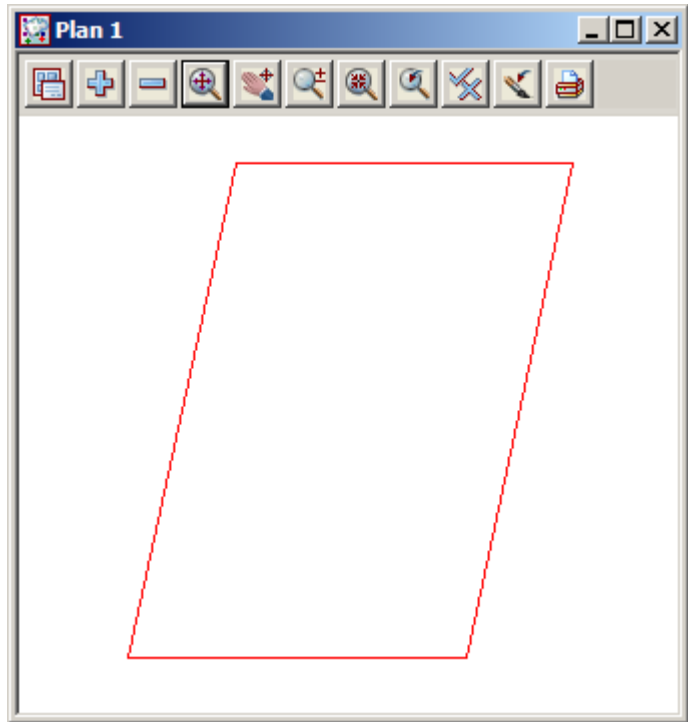
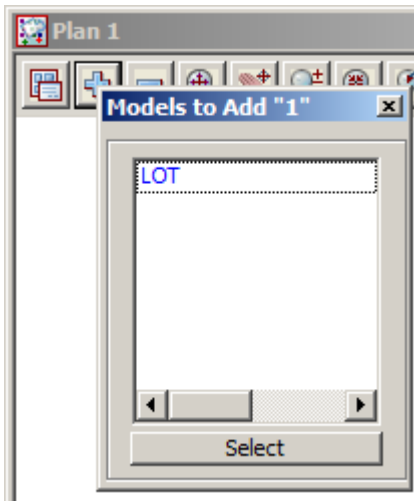

11.2.2 Read in the CAD file

Select option *File I/O=>Data Input=>DWG/DXF/DXB*

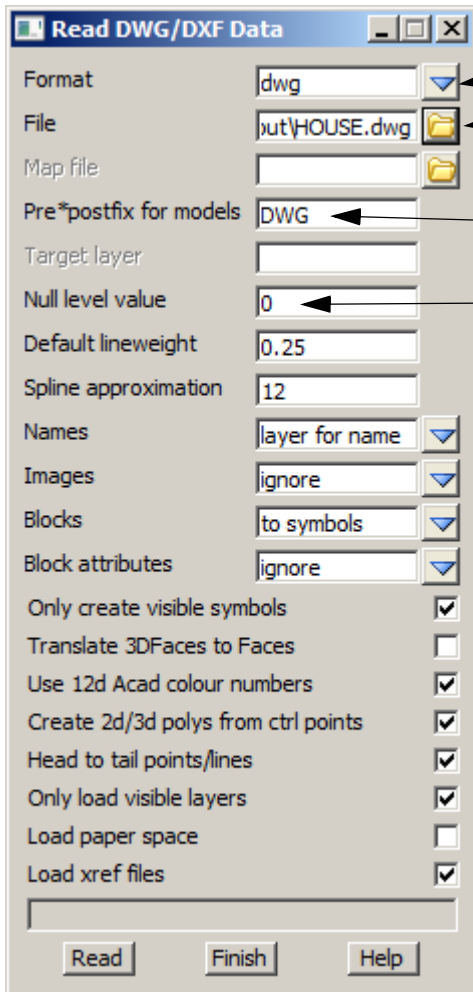

- ← Select format **DWG**
- ← Browse to the folder **C:\12d\9.00\Training\survey\setout** and select the file **HOUSE.DWG**
- ← Type in **DWG**<space> as the prefix for the loaded models
- ← Type in **0** to ensure any 2d data is nulled
- The rest of the panel can remain unchanged

Select **Read** then **Finish**

The house outline has been created in plan millimetres and will result in the house being scaled by 1000 if opened in the same view as the lot. Turn off the newly imported model in plan 1.

We will therefore create a new plan view using option *View=>New=>Plan*

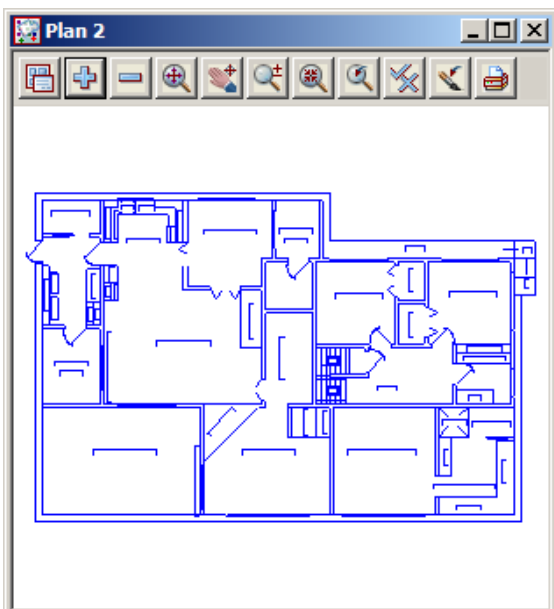

Turn on the HOUSE models

11.2.3 Scale the house models

The imported building has its base units in millimetres rather than metres and is located a large distance from the lot. We will firstly scale the building from millimetres to metres

Select option *Utilities=>A-G=>Factor*

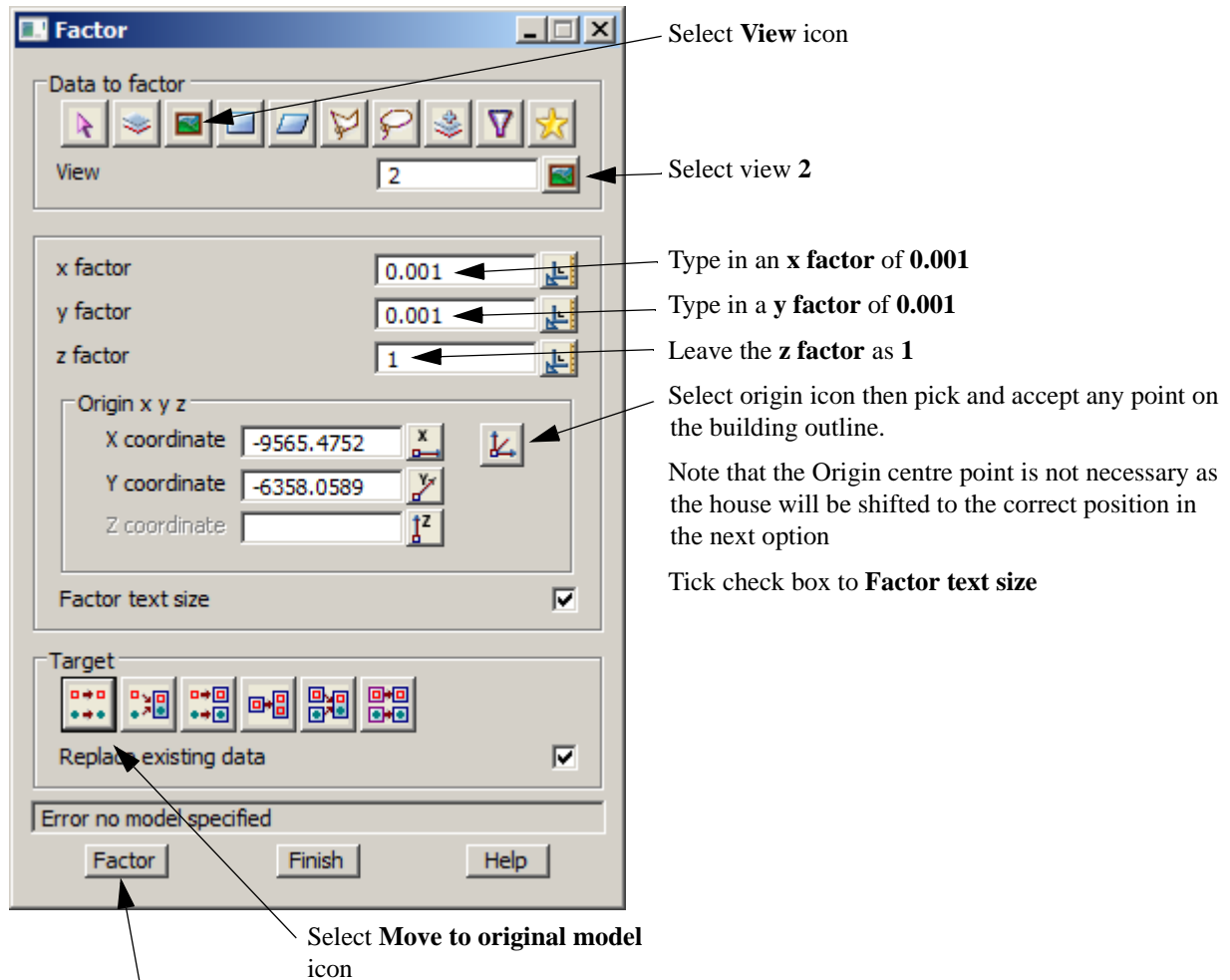

Select **Factor** then **Finish**

Zoom all of the house models

11.2.4 Rotate the building

We will now rotate the house.

Select the option *Utilities=>H-Z=>Rotate*

Select **View** icon

Select view **2**

Select Rotation centre icon then pick and accept any point on the building outline.

Note that the rotation centre point is not necessary as the house will be shifted to the correct position in the next option

Type in the rotation. In this example we have typed in the bearing of the house edge and subtracted the bearing of the left side boundary line

Tick **Anticlockwise** check box

Select **Move to original model** icon

Select **Rotate**

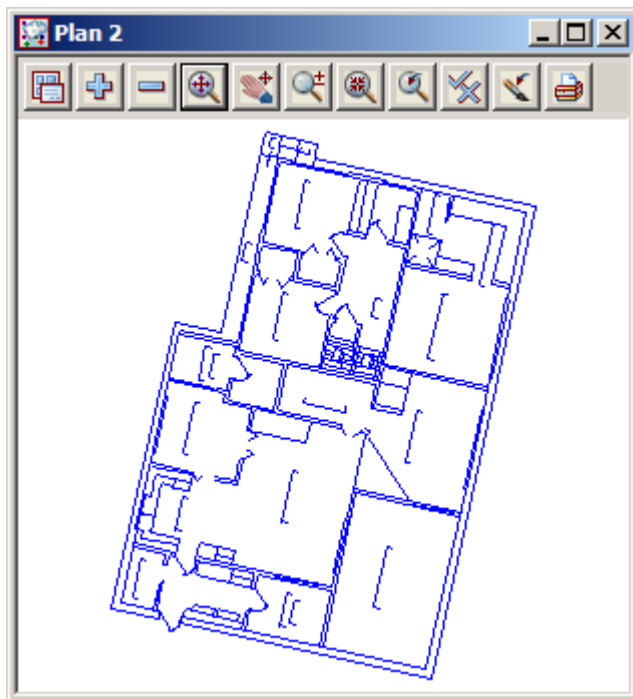

11.2.5 Translate the house

We will now position the house into the lot and place the corner at a predefined position

Select the option *Utilities=>H-Z=>Translate*

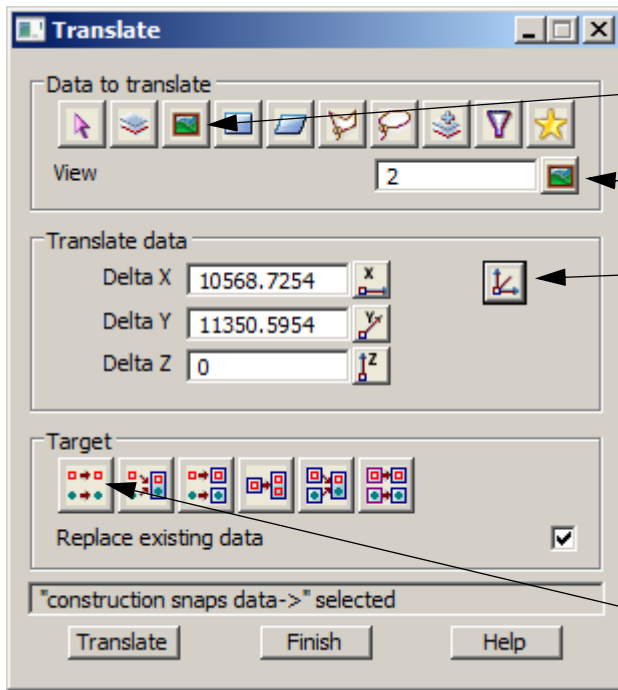

Select **View** icon

Select view 2

Select the Position icon

Select and accept the top left corner of the house in plan view 2. In plan view 1 pick a point 7 metres up from the front left corner and in 1.8 metres in from the left boundary. This is explained in the previous setout option

Select **Move to original model** icon

Select **Translate**

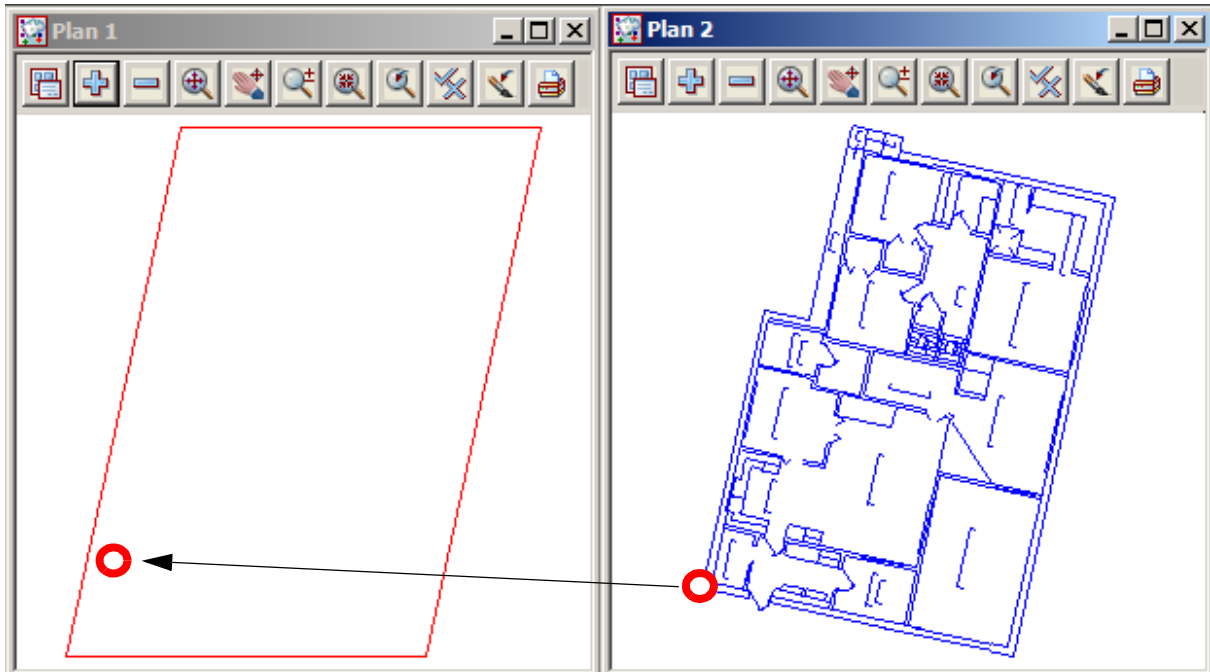

In plan view 1 turn on the house models

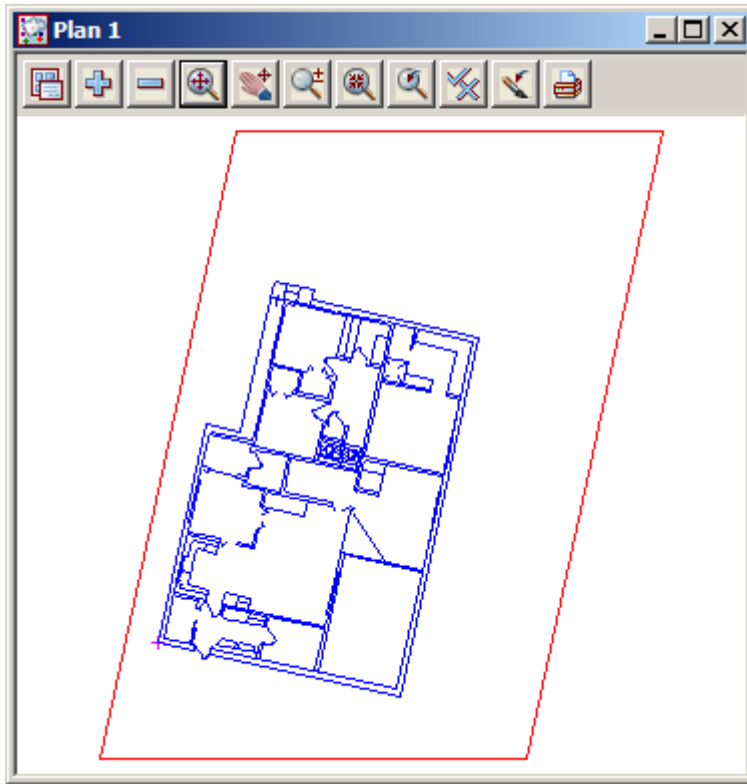

11.2.6 Create outline of house for setout

We will now create a string around the outside edge of the cad house. This is done in a model called **HOUSE**

Type in the name and model name **HOUSE** in the **CAD controlbar**. Select the colour **Green** and linestyle **1**



A weight of 3 will help identify the string from the underlying string

Select option *Strings=>Cad=>Lines=>Line string*
or **Create Line String** icon

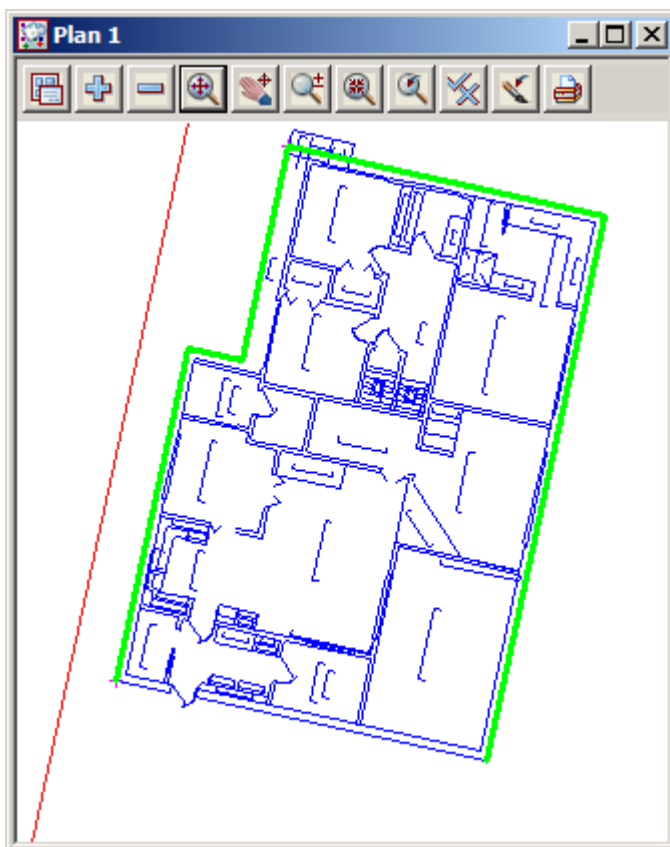
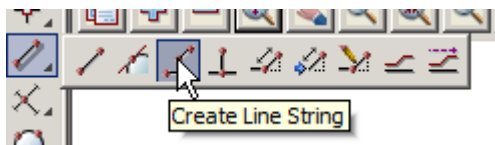

Pick and accept the corner points of the cad house

Don't create the string back onto the start point. Press **[Escape]** to exit the string option

To close the string select *Strings=>Strings edit=>Close*

or **String Close** icon

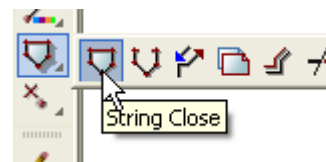

The dimensioning and setout numbers can be created as per the previous chapter

11.3 Setout for evenly graded string

In this exercise we will manually import a polyline from cad, regrade the string and create manual setout points for uploading.

Create a new project as shown previously called **DRAIN SETOUT** in the folder

C:\12d\9.00\Training\survey\setout\DRAIN SETOUT

Remember to select the configuration **GETTING STARTED SURVEY**

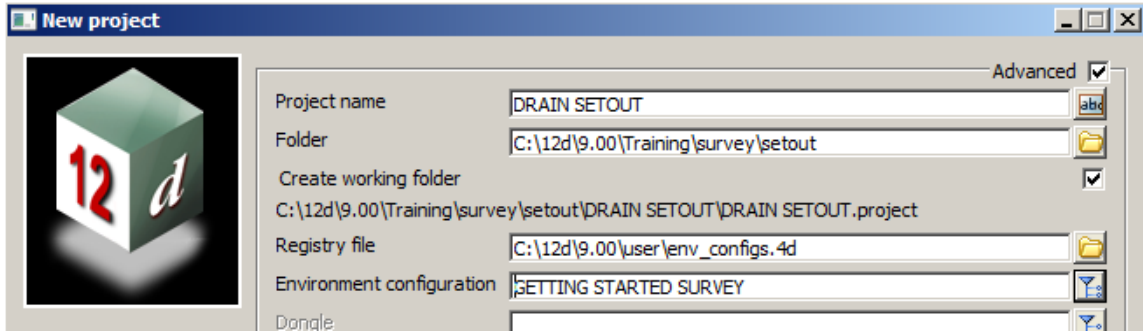

11.3.1 Read in the polyline from cad

Select option *File I/O=>Data Input=>DWG/DXF/DXB*

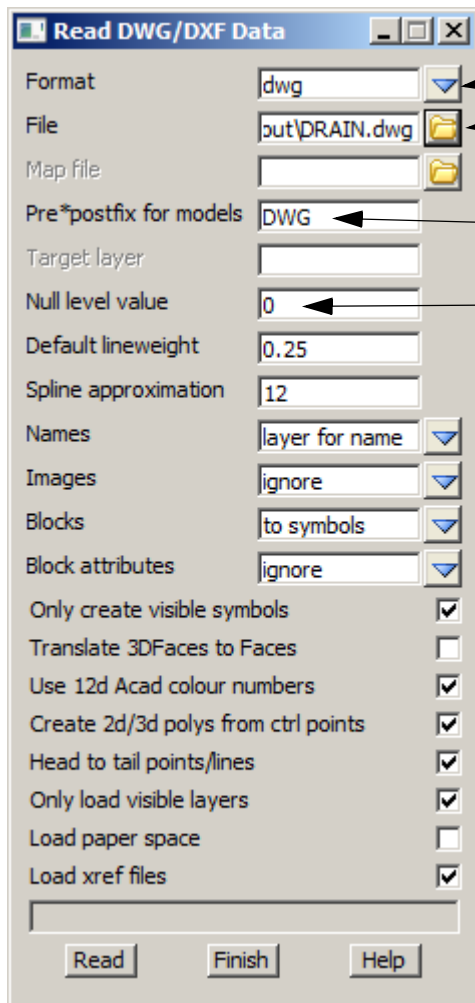

- ← Select format **DWG**
- ← Browse to the folder **C:\12d\9.00\Training\survey\setout** and select the file **DRAIN.DWG**
- ← Type in **DWG**<space> as the prefix for the loaded models
- ← Type in **0** to ensure any 2d data is nulled
- The rest of the panel can remain unchanged

Select **Read** then **Finish**

Turn on the model **DWG DRAIN**

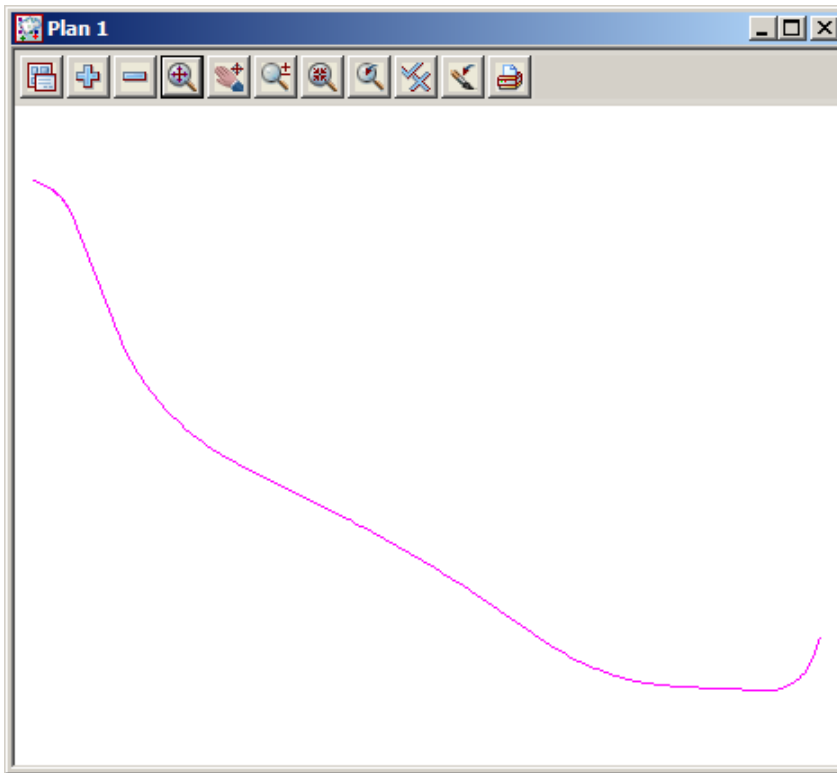

11.3.2 Convert the polyline to a super alignment string

The imported polyline has no height but the string is to be evenly graded from level 20.0 to level 25.0

We will convert the polyline to an super alignment to grade the string. The option to be used will filter any duplicate points normally created at tangent points due to rounding errors. This is done in two stages

Poly to alignment

Select *Utilities=>A-G=>Convert=>Poly to alignment*

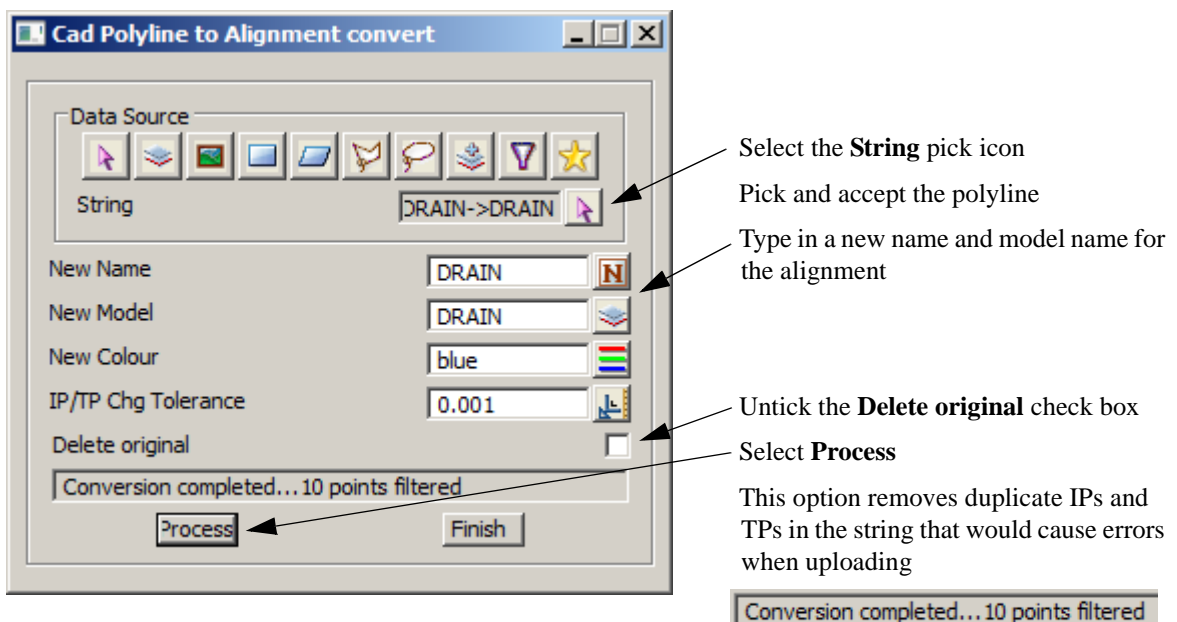

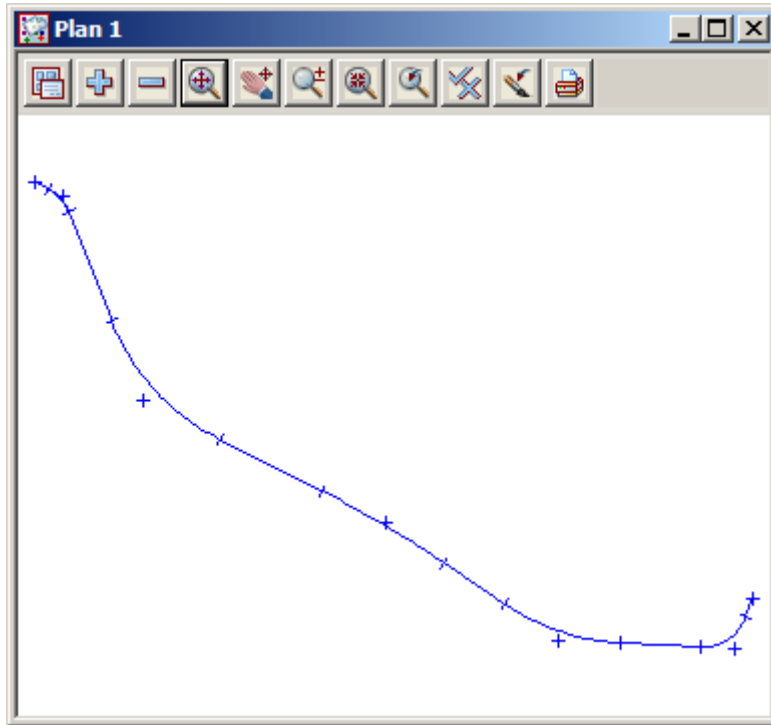

Turn off the original string model then turn on the new **DRAIN** model

Alignment to super alignment

Select *Strings=>Convert*

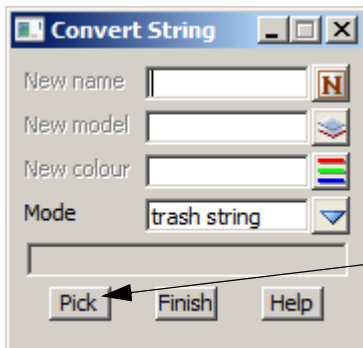

Leave the panel unaltered

Select **Pick**

Select the newly created alignment string

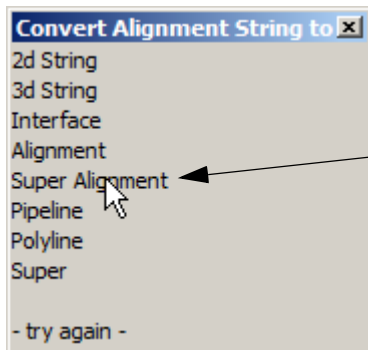

Select **Super Alignment**

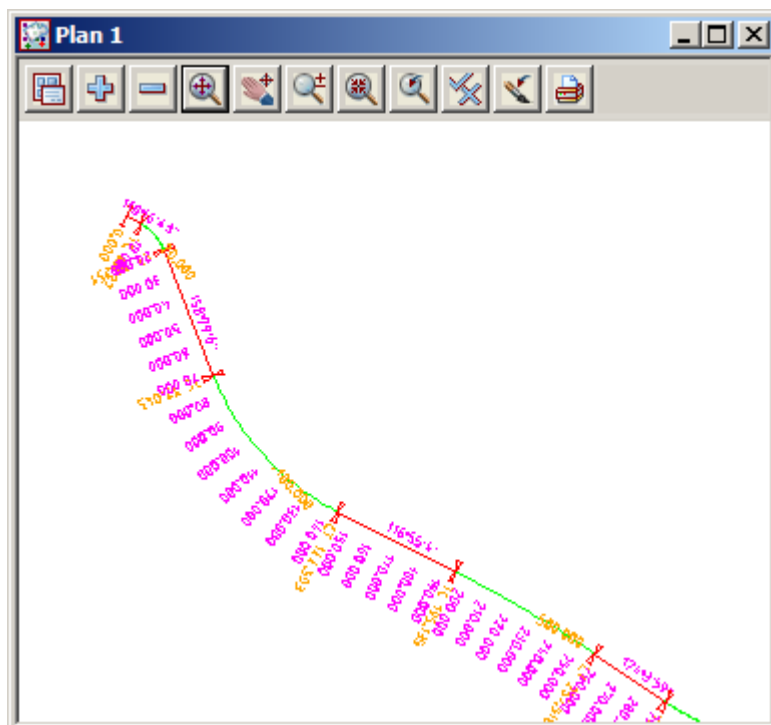
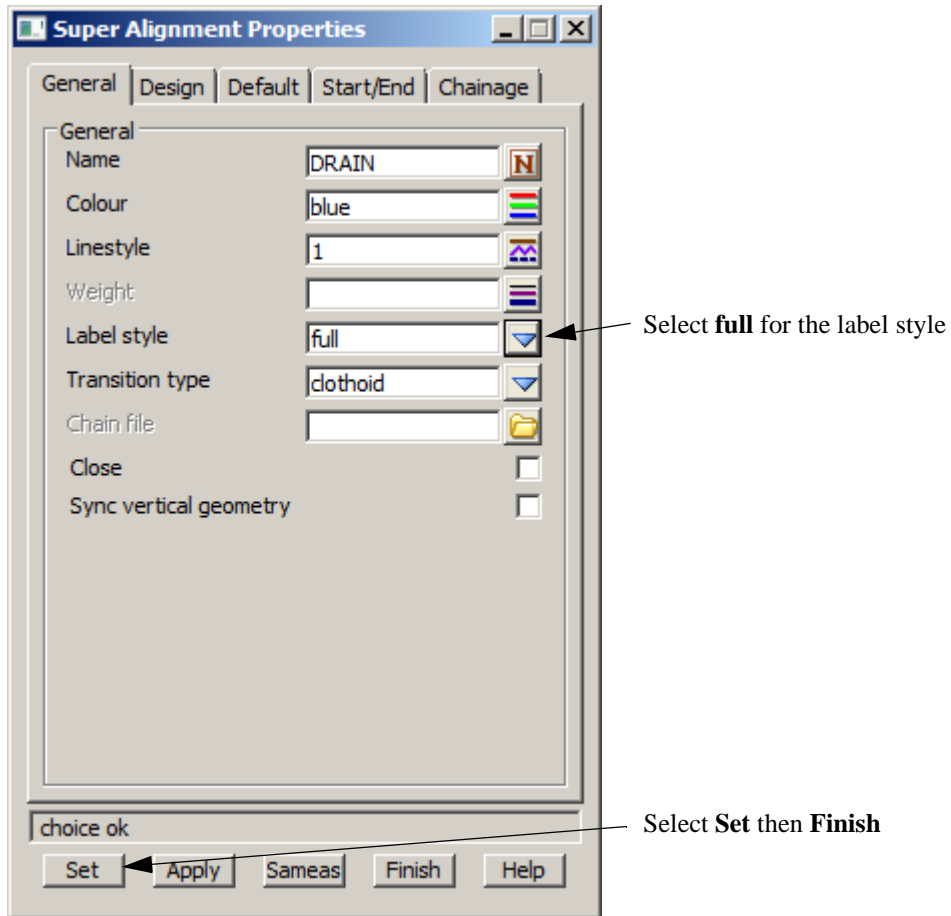

11.3.3 Create heights for each end of the alignment

We need to firstly create a section view to profile the alignment

Select **View=>New=>Section**

Select the profile icon then pick and accept the alignment string in the plan view

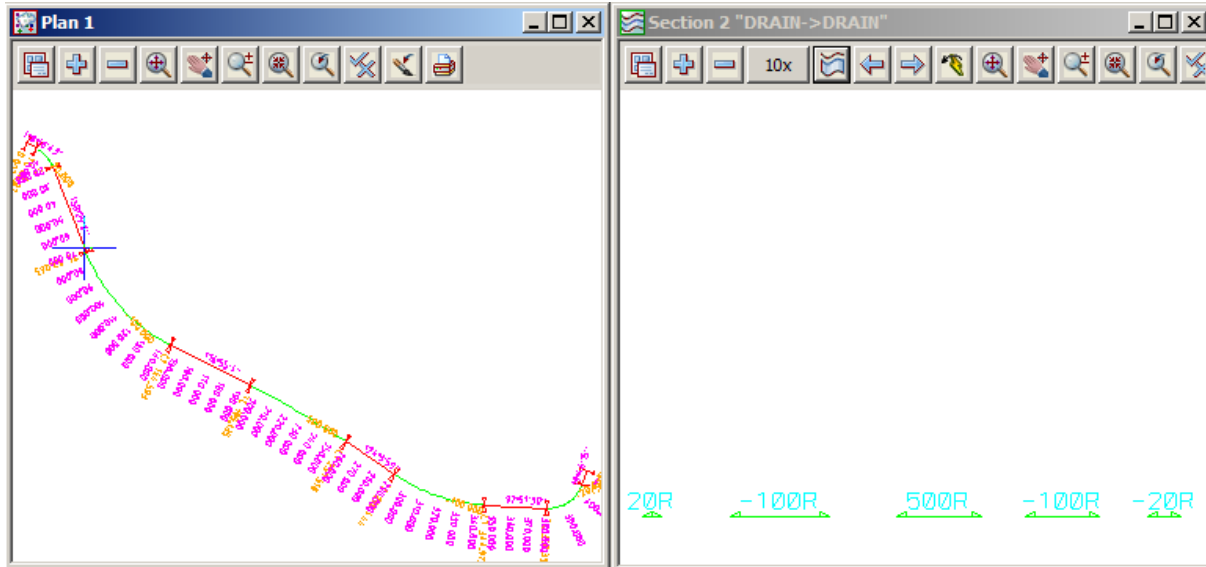

To edit the alignment string select **Strings=>Editor** or **[F6]**

Pick and accept the alignment string



The alignment editor appears

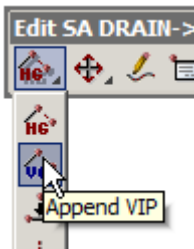

To add vertical geometry hold the left button down over the **Add/Remove IPs** icon then select **Append VIP**

Keeping the cursor in the section view press the **Space** bar to bring up the input panel

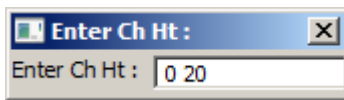

Type in **0 (space) 20 [Enter]**

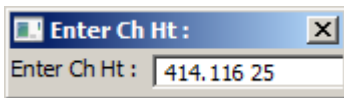

For the end height type in **414.116 (space) 25 [Enter]**

Press **Escape** key to exit the option

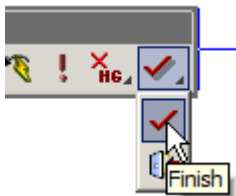

To exit the alignment editor hold the left button down over the **Finish** icon then select **Finish**

Select **Yes** to confirm finishing

11.3.4 Create special chainage file for setout points

The string is to be setout every 10 metres with tangent points included so we need to create a file of chainages that will be used in the setout option

Select **Design=>Roads=>More=>Special chainage file**

or **Special Chainage File** icon

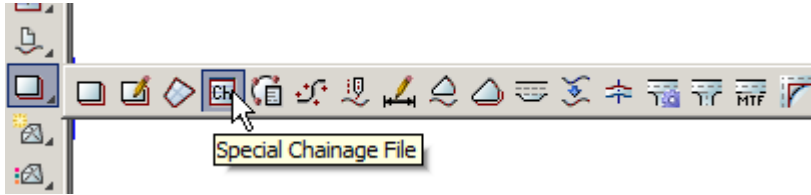

Press **Reference** and pick the alignment string

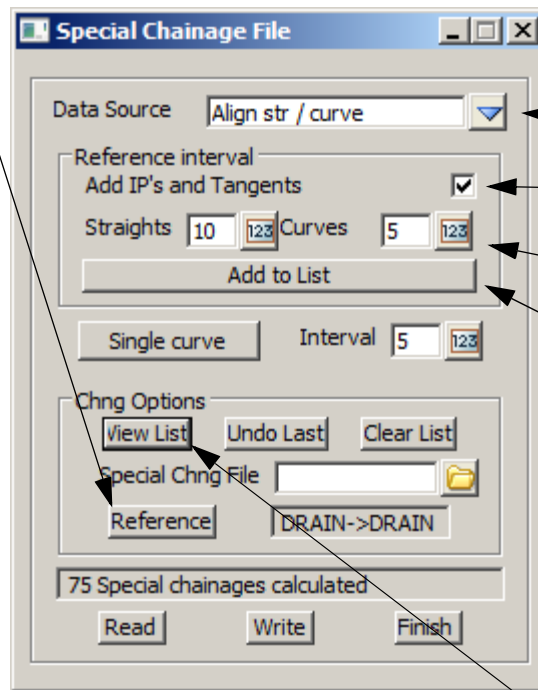

Change the **Data Source** option to **Align str / curve**

Tick check box to **Add IP's and Tangents**

Type in the straight spacing **10** and the Curve spacing as **5**

Select **Add to List**

Select **View List**

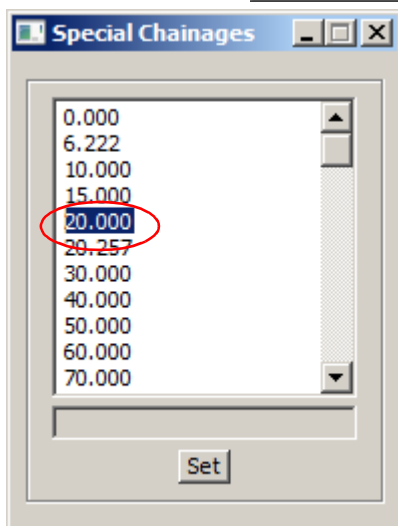

The chainages are listed. Duplicate and very close chainages can be deleted in this list

Select **Set** to close the file

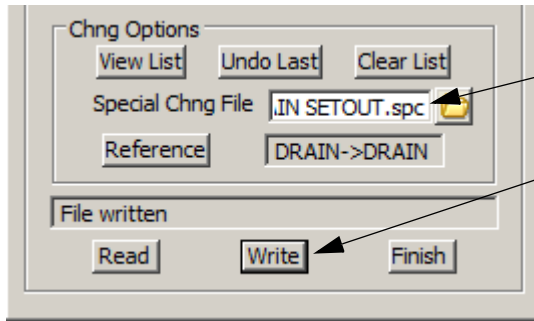

Type in the file name **DRAIN SETOUT**

Select **Write** then **Finish**

11.3.5 Create setout points

We will now generate point numbers for the alignment

Select option *Survey=>Setout=>Setout point using super string*

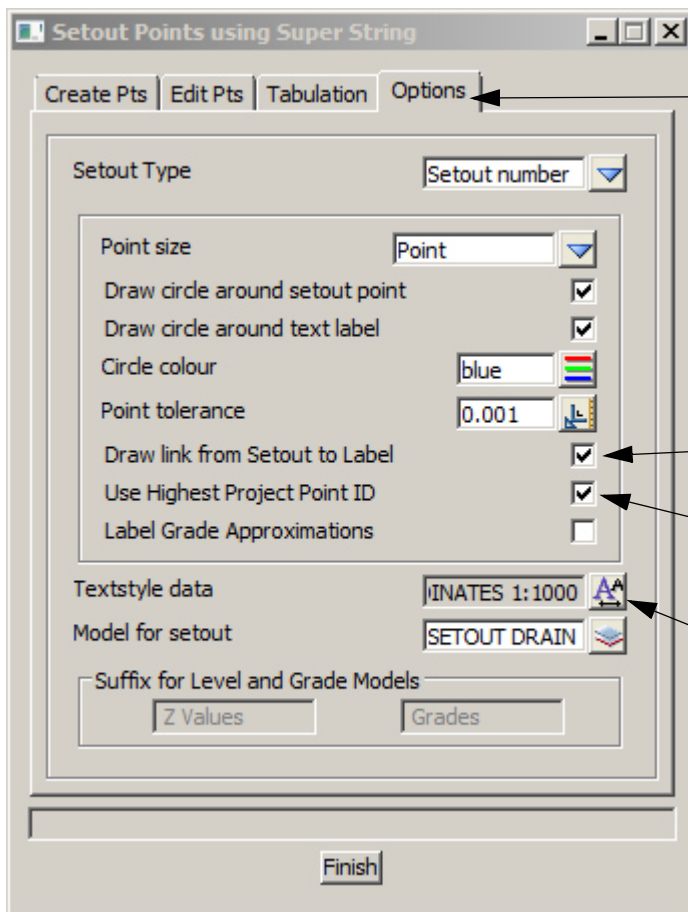

Select the **Options** tab

Prior to running the option we will set up some parameters

Tick the check box to **Draw link from Setout to label**

Tick the check box to **Use Highest Project Vertex ID**

Select the **Textstyle data** icon and select **CO-ORDINATES 1:1000**. This will ensure the text is the right height for a 1:1000 plot

Type in model **SETOUT DRAIN**

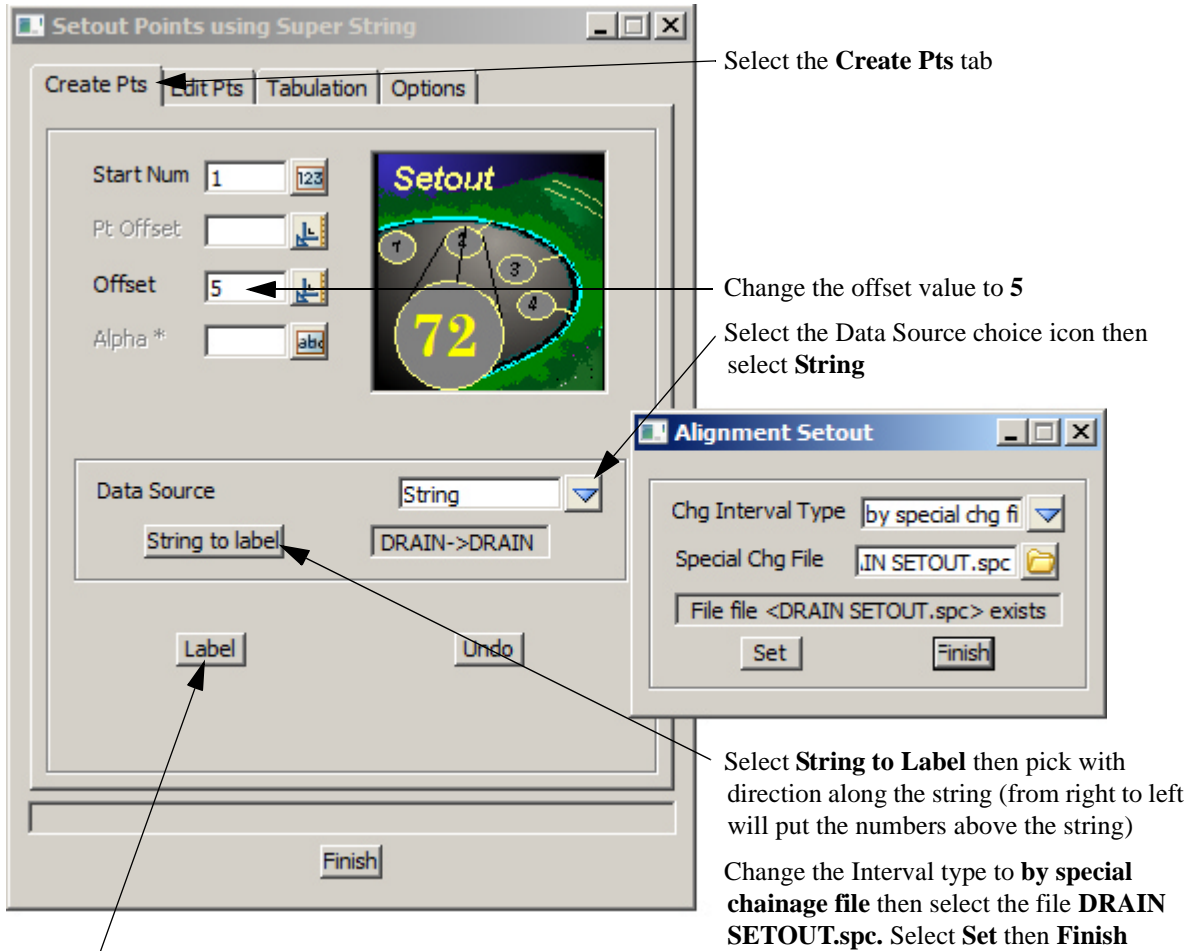

Select **Label**

Any overlapping numbers can be moved as shown previously

The points can now be uploaded to an instrument as shown previously

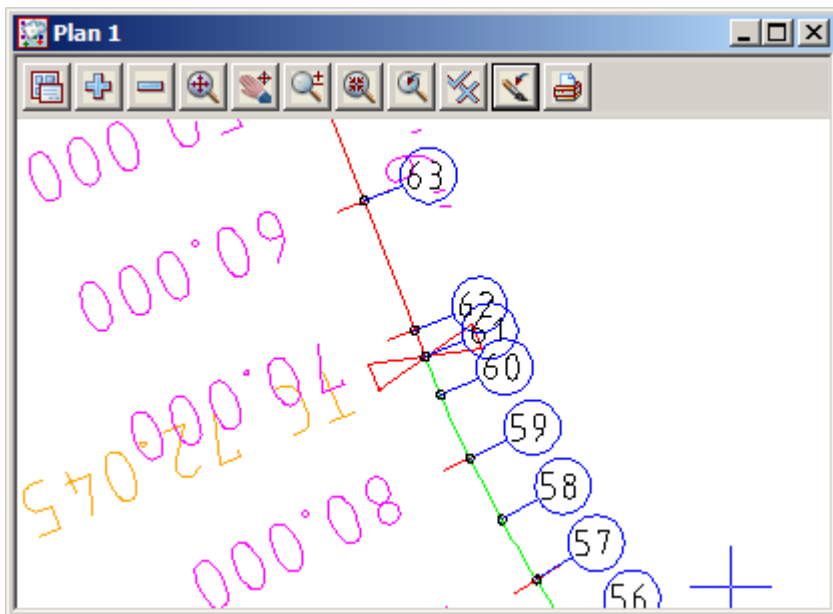

11.4 Setout for polyline culdesac string

In this exercise we will import a 2d lip of kerb polyline from cad and create heights from a provided layout drawing

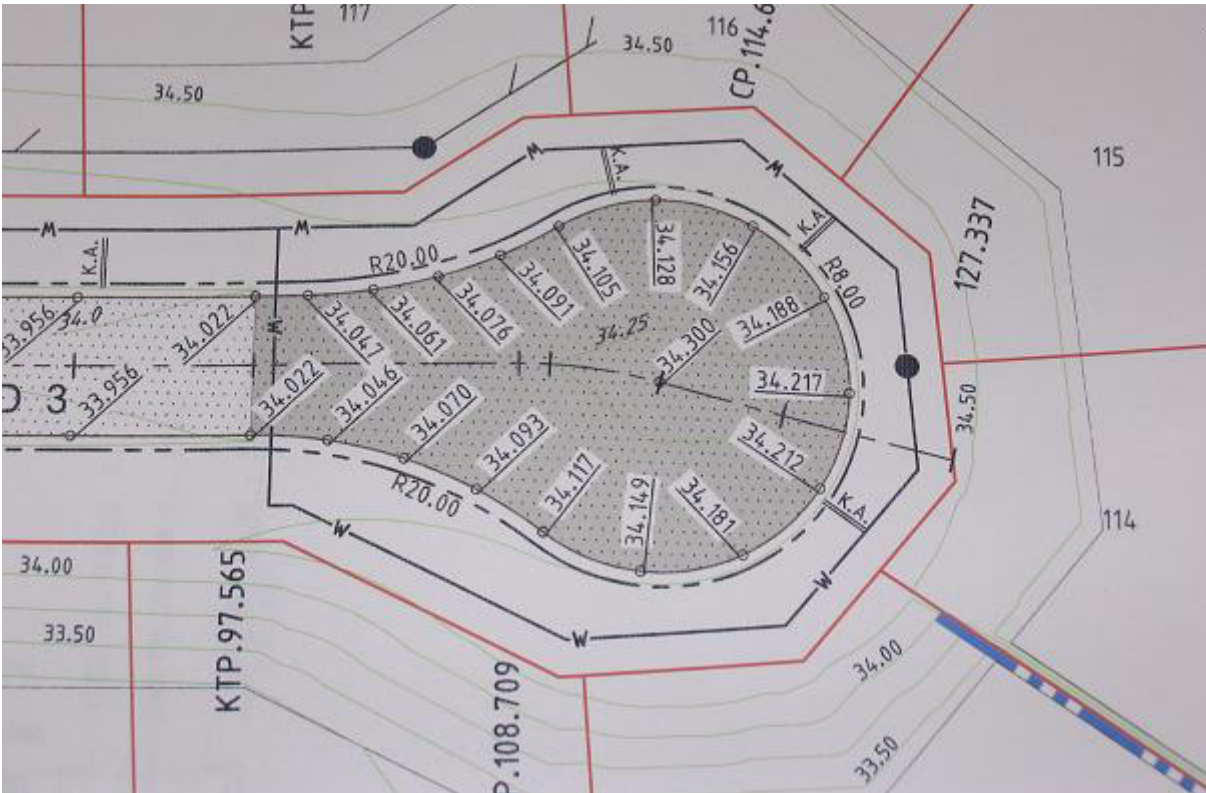

Create a new project as shown previously called **CULDESAC SETOUT** in the folder

C:\12d\9.00\Training\survey\setout\CULDESAC SETOUT

Remember to select the configuration GETTING STARTED SURVEY

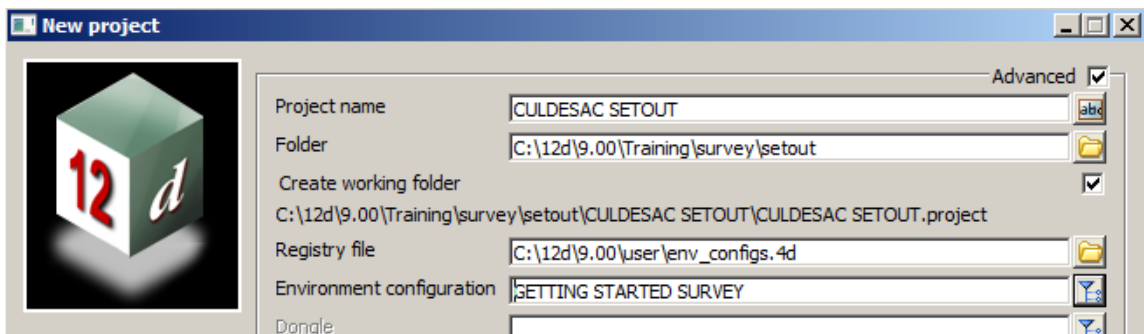

11.4.1 Read in the polyline from cad

Select option *File I/O=>Data Input=>DWG/DXF/DXB*

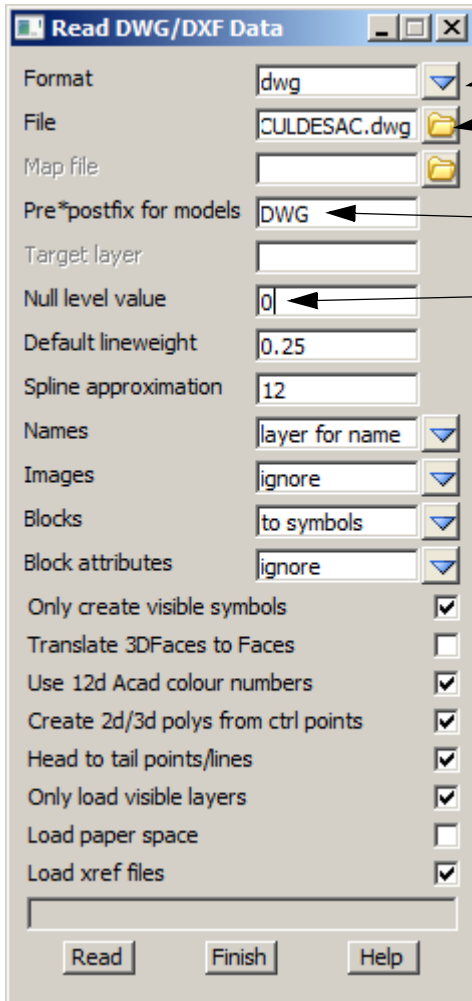

Select format **DWG**

Browse to the folder
C:\12d\9.00\Training\survey\setout and
select the file **CULDESAC.DWG**

Type in **DWG**<space> as the prefix for
the loaded models

Type in **0** to ensure any 2d data is nulled

The rest of the panel can remain
unchanged

Select **Read** then **Finish**

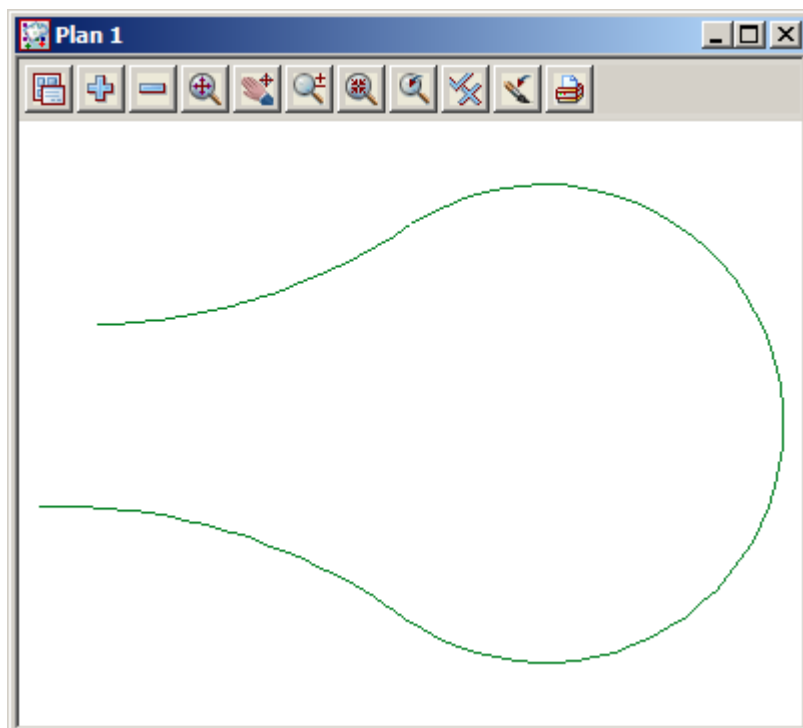

11.4.2 Filter the imported string to ensure there are no duplicate vertices at the tangent points

Turn on the vertex indices

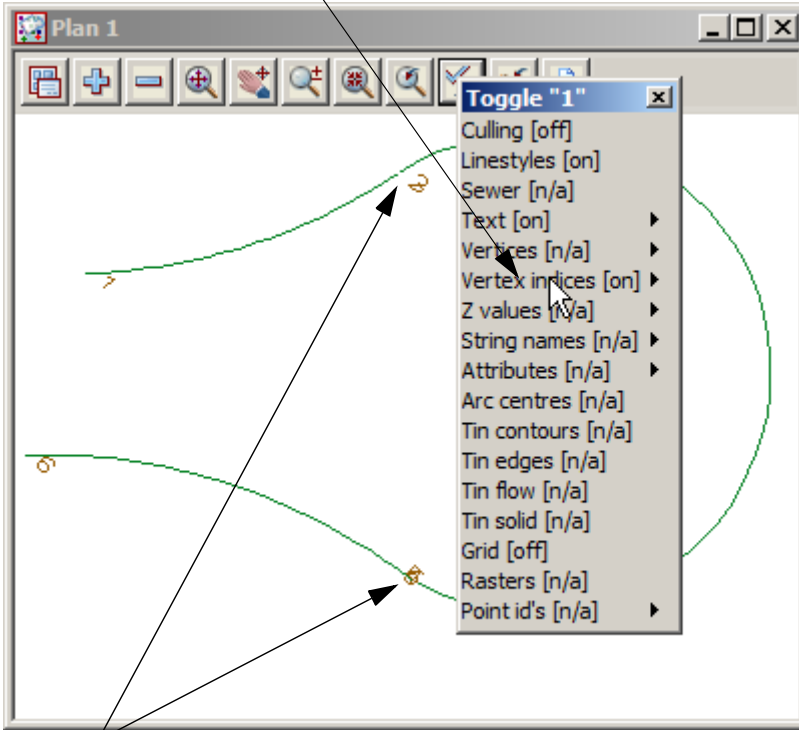

Occasionally duplicate vertices will occur. These are highlighted by the overlapping numbers

Select option *Utilities=>A=G=>Filter=>Vertex filter*

The screenshot shows the 'Filter adjacent vertices in' dialog box. It has several sections:

- Data to filter:** A row of icons for selecting data. The 'String' icon is selected. Below it, the string 'LIP->KERB LI' is entered.
- Dimension:** A dropdown menu set to '3d'.
- XY tolerance:** A text field containing '.001'.
- Z tolerance:** An empty text field.
- Vertices with attributes:** A dropdown menu set to 'Ignore / Skip'.
- Segments with attributes:** A dropdown menu set to 'Ignore / Skip'.
- Target:** A row of icons for target actions. The 'Move to original model/replace' icon is selected.
- Replace existing data:** A checked checkbox.
- Status bar:** Shows '"DWG KERB LIP->KERB LIP" selected'.
- Buttons:** 'Filter', 'Finish', and 'Help'.

 Annotations with arrows point to:

- The 'String' icon in the 'Data to filter' section.
- The 'String pick icon' in the 'Data to filter' section.
- The '3d' dropdown in the 'Dimension' section.
- The '.001' text field in the 'XY tolerance' section.
- The 'Move to original model/replace' icon in the 'Target' section.

Select **Filter** then **Finish**

The duplicate vertices are removed. Now remove the vertex indices

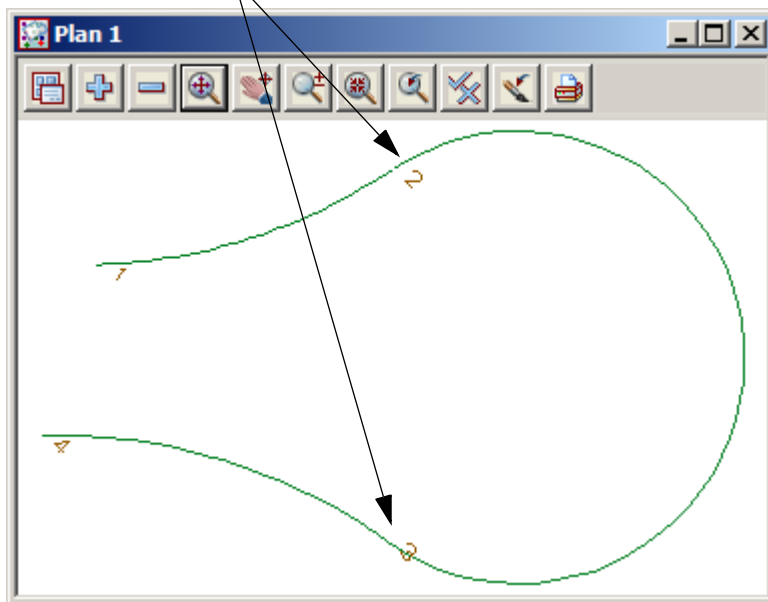

11.4.3 Segment the string

We now segment the string into the equal parts shown in the diagram at the start of this topic.

Firstly toggle on the vertices and toggle off the vertex indices.

Select option *Strings=>Strings edit=>Segment strings*

Select **Pick** then select the first segment
 Type in **4** as number of parts
 Select **Process**
 .Repeat for each segment of the string

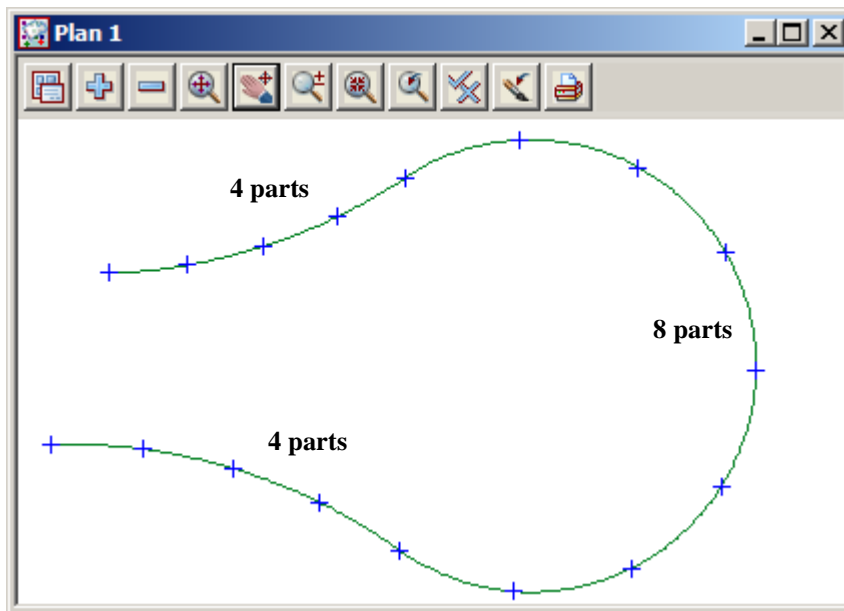

11.4.4 Add heights to string

Heights will be added from the diagram

Toggle on the Z values (No levels appear yet)

To edit the string select **Point height** icon

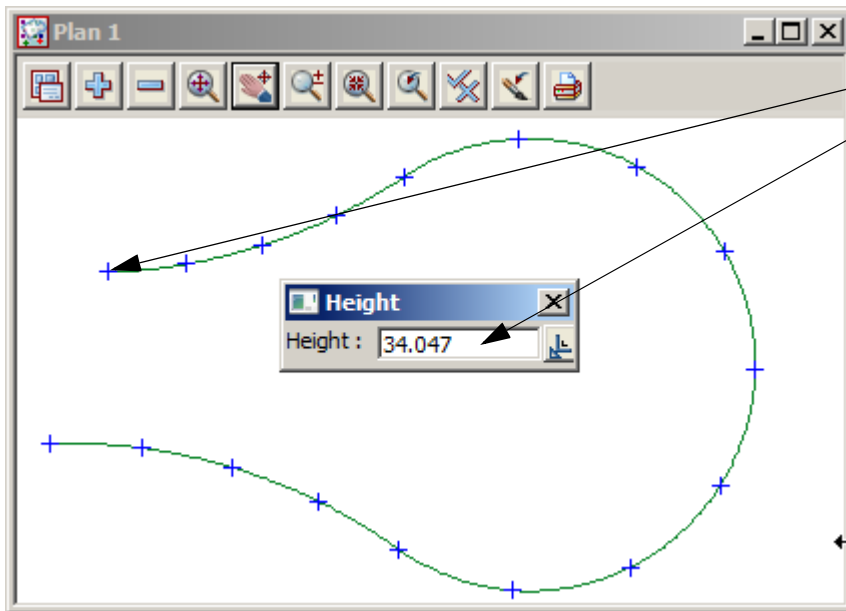
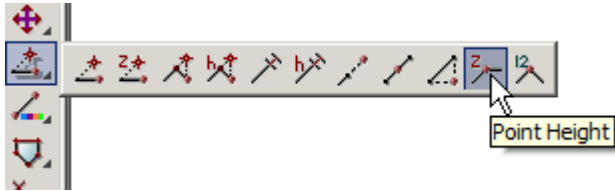

Select the first vertex

Type in the height 34.047 [Enter]

Repeat for each of the points

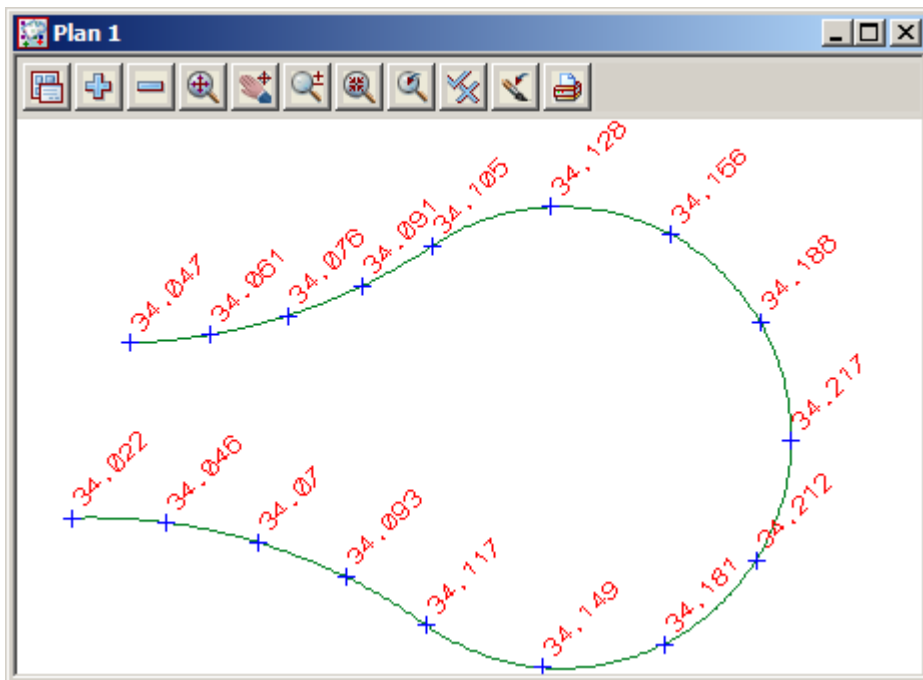

11.4.5 Parallel the lip string for setout

The lip will be paralleled to create setout points. The heights will be raised 0.11 to relate to the kerb level and the offset will be 0.5 behind the back of kerb

Add a new name and model **KB OFFSET 500** to the cad control bar

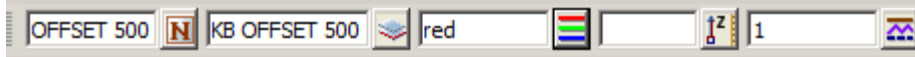

Select **String Parallel** icon

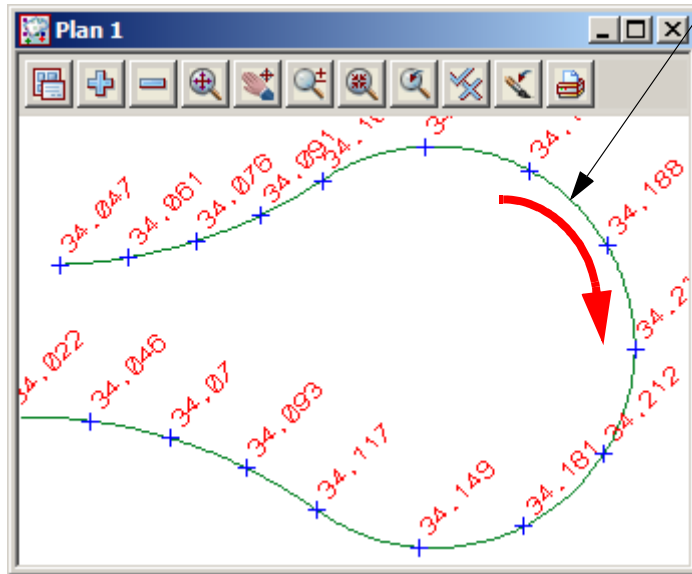
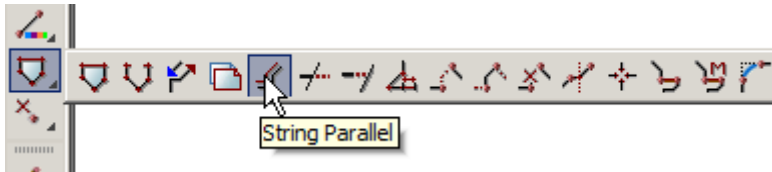

Select and accept with direction the kerb in a clockwise direction

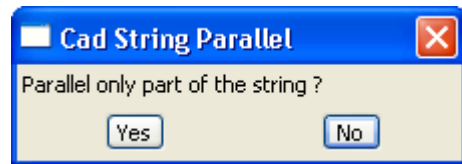

Select **No** to parallel whole string

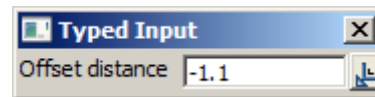

Type in offset **-1.1 [Enter]**

Type in offset height **0.11 [Enter]**

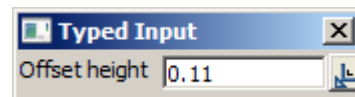

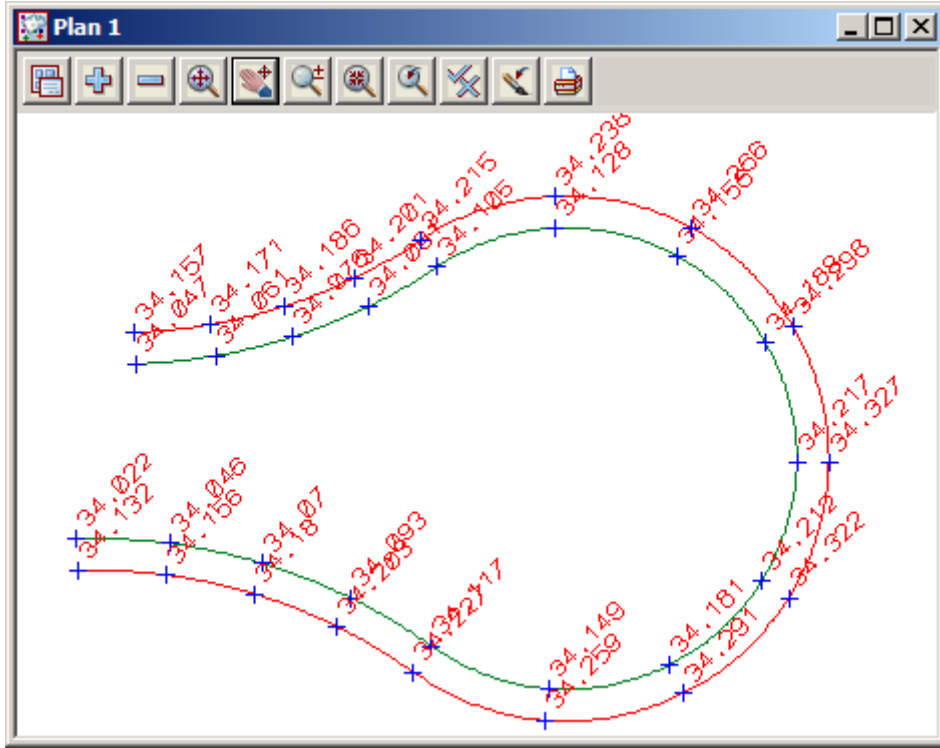

The creation of the point numbers for upload is discussed in the previous chapters

11.5 Triangulation setout

In this topic we will use a triangulation of a surface to create an upload file to be used in a data collector

Create a new project as shown previously called **ROAD SETOUT** in the folder

C:\12d\9.00\Training\survey\setout\ROAD SETOUT

Remember to select the configuration **GETTING STARTED SURVEY**

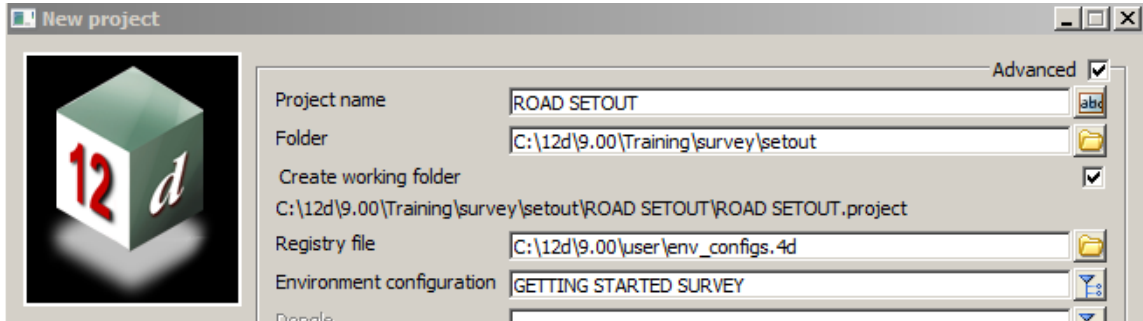

11.5.1 Import file

We will read road surface and strings from a 12d ascii file

Select option *File I/O=>Data Input=>12da/4da data*

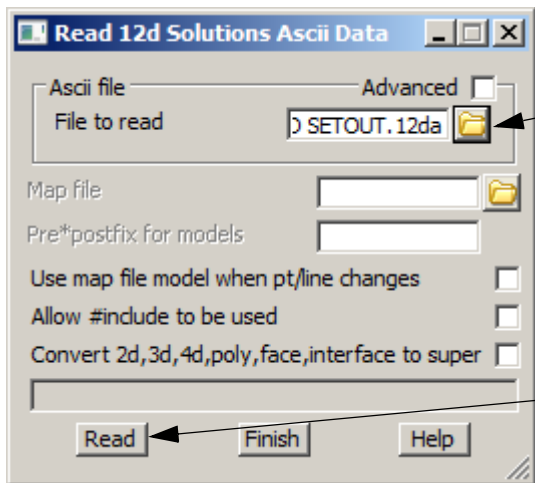

Browse to the folder
C:\12d\9.00\Training\survey\setout and
select the file **ROAD SETOUT.12da**

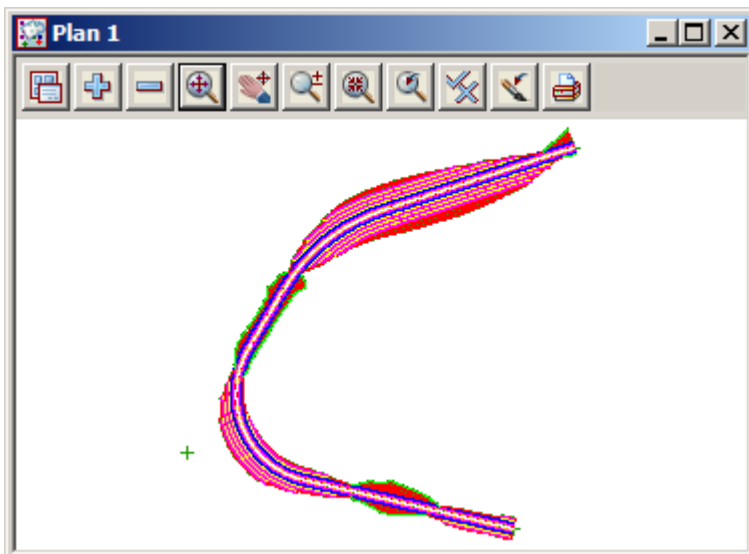

11.5.2 Create upload file of the triangles

The triangles can be written to an upload file. We will use the option to upload the triangles to the Trimble instrument

Select option *Survey=>Upload=>Create triangle upload file*

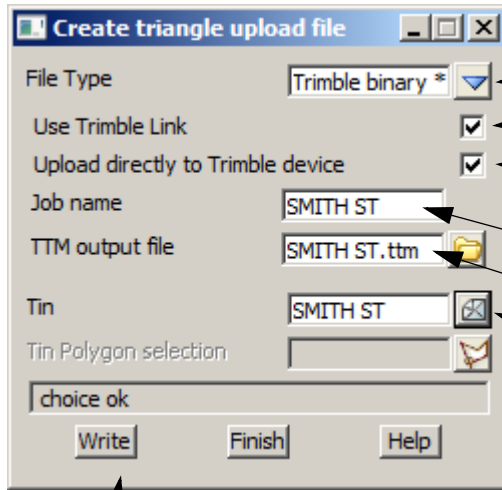

Select **File Type** choice icon

Select **Trimble binary *.ttm**

Tick the check box to **Use Trimble Link**

Tick the check box to **Upload direct to Trimble Device**

Note: Trimble Link has to be installed to use this option

Type in a job name for the tin

Type in a file name

Select the tin **SMITH ST**

Select **Write** to create the file

The number of triangles selected are displayed

Select **Yes** to continue

The file is created

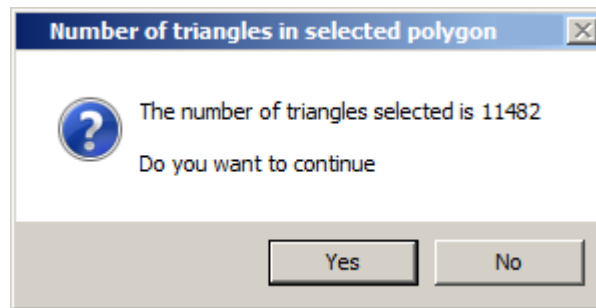

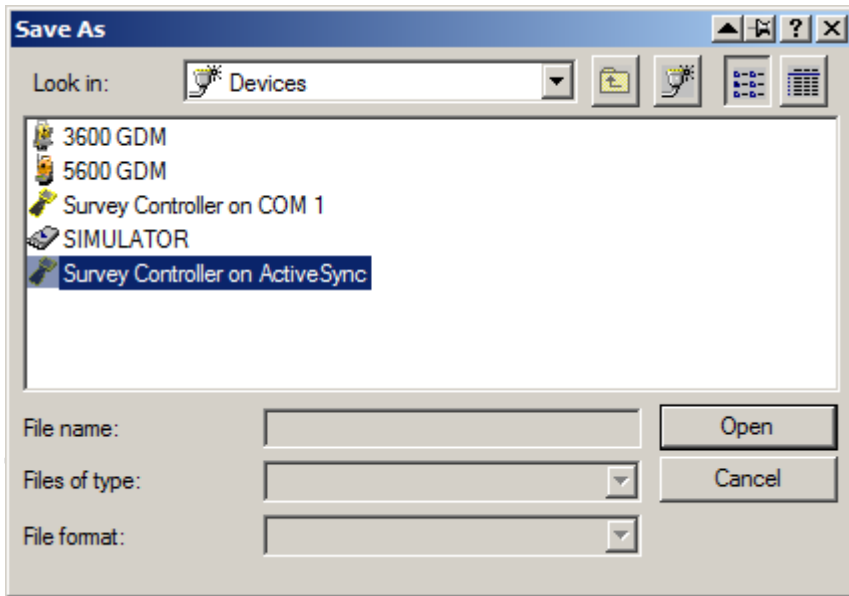

The device can be selected for uploading

Once uploaded to the instrument the tin can be used in setout options

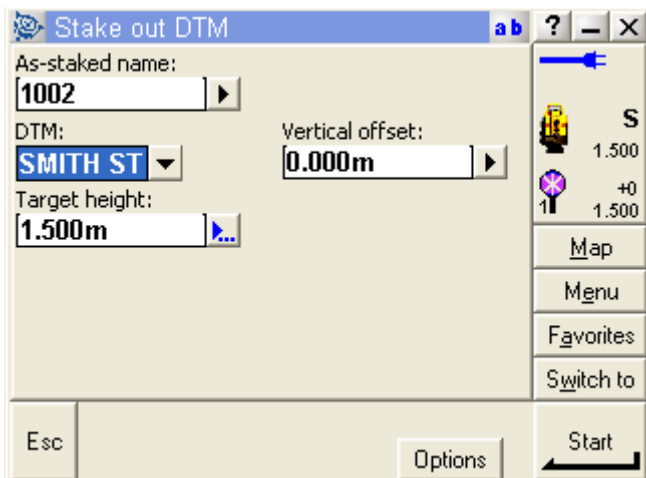

Triangulation setout

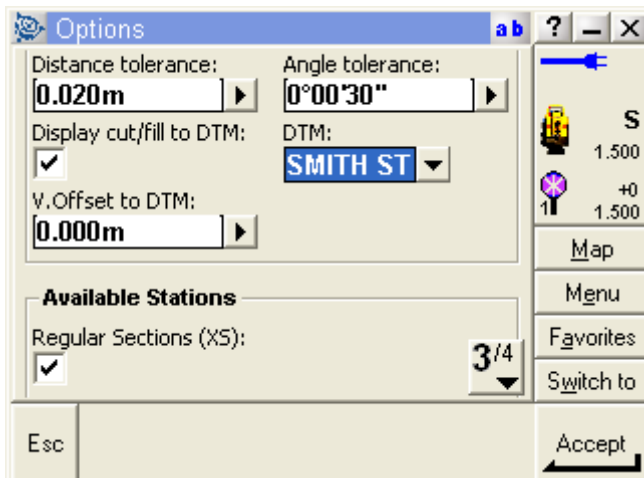

Road setout with tin used for heights

11.6 Road Setout

In this topic we will create an upload file of the horizontal and vertical alignment along with the strings or cross sections. We will use the previous Project otherwise create a new project and read in the ascii file described in the previous chapter

Turn off the model **tin SMITH ST**
then turn on models on the road models

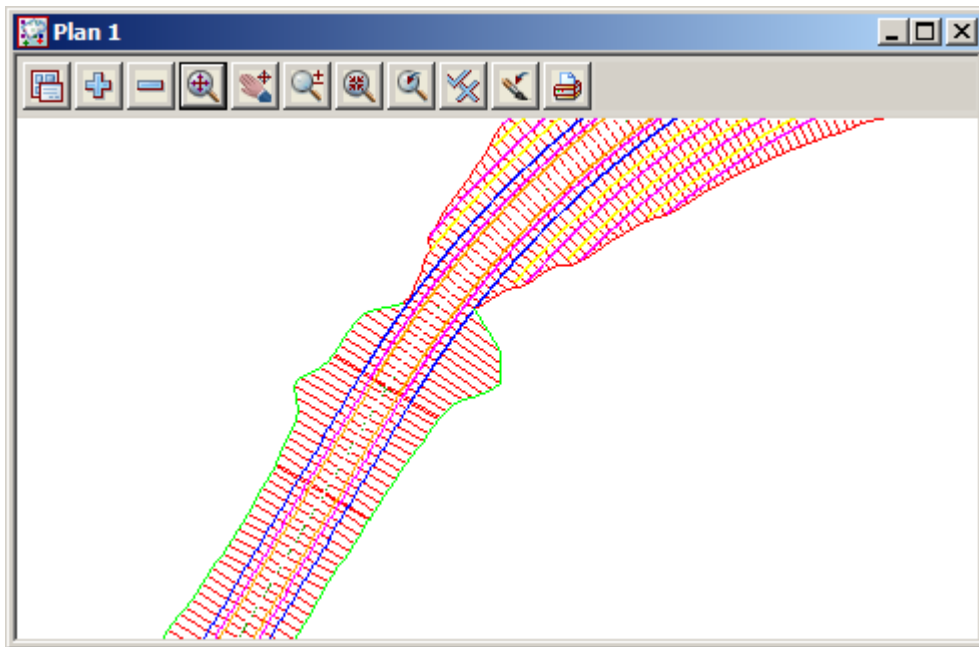

11.6.1 Create upload file of road alignment for Leica 1200

The Leica 1200 Road Runner program can accept the alignment and strings for a road setout

Select option *Survey=>Leica=>1200=>Roads*

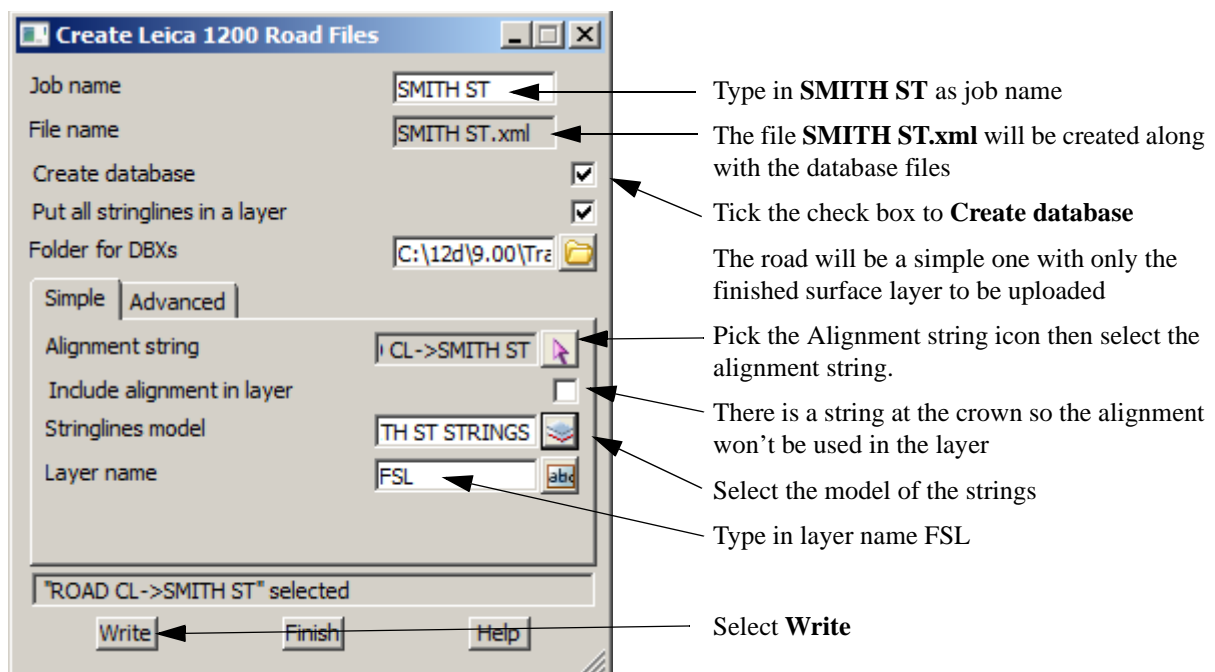

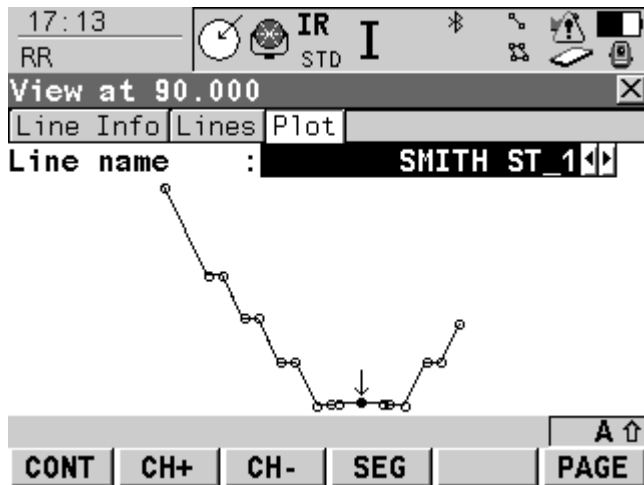

On board the Leica the strings are cut at the required chainage and a section can be viewed

11.6.2 Create upload file of road alignment for Trimble

The Trimble instruments can accept the alignment and sections for a road setout

Select option *Survey=>Upload=>Create road upload file (new)*

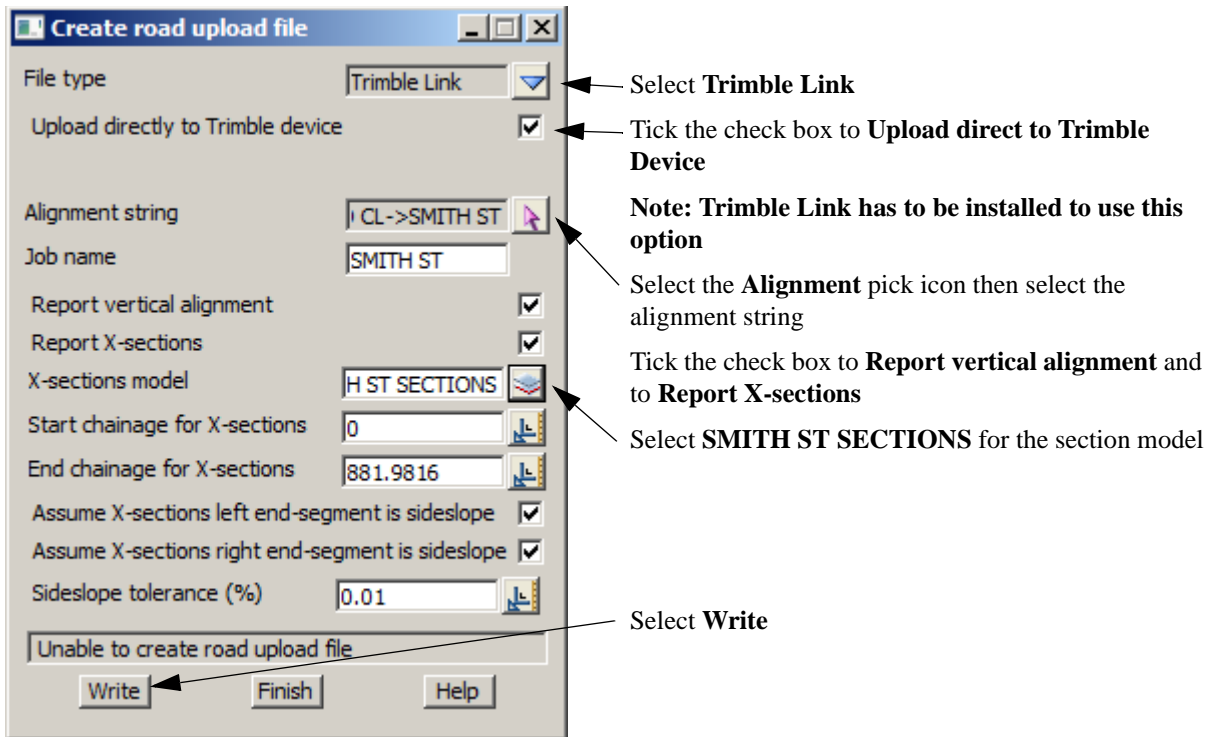

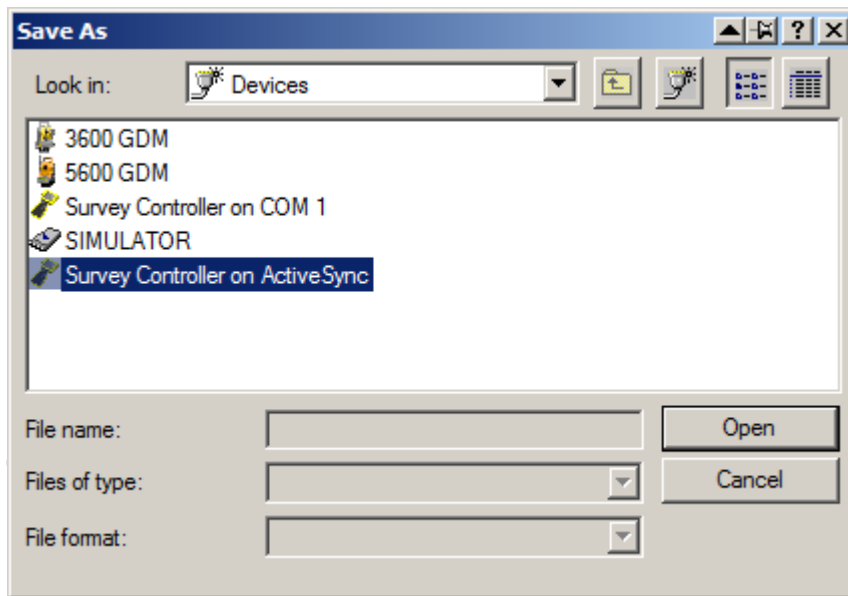

The device can be selected for uploading

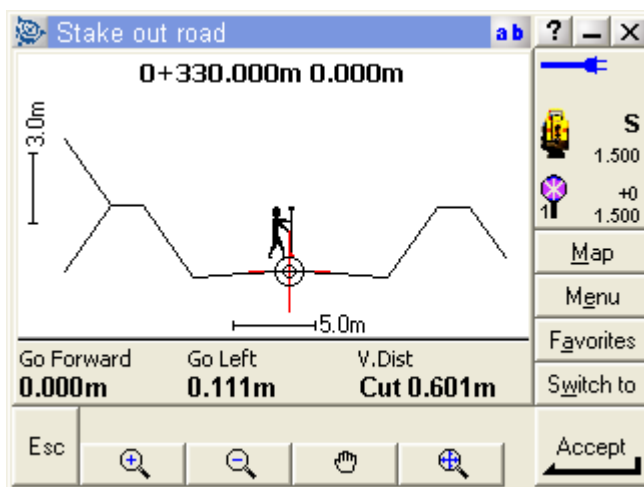

On board the Trimble the road sections can be setout

11.7 Setout reports

The final position of the Setout points can be checked against the design in a number of ways
We will look at three ways

11.7.1 Read in Ascon survey

We will read in an ascii file of the ascon survey. The file also contains some design positions of light poles
Turn off all of the models in plan view 1 prior loading in the file
Select option *File I/O=>Data Input=>12da/4da data*

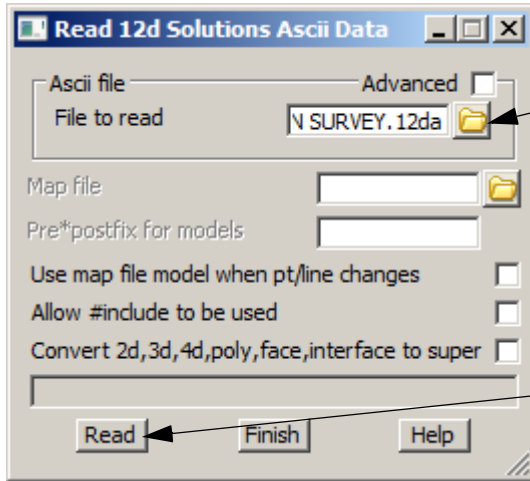

Browse to the folder
C:\12d\9.00\Training\survey\setout and select
the file **ROAD ASCON SURVEY.12da**

Select **Read**

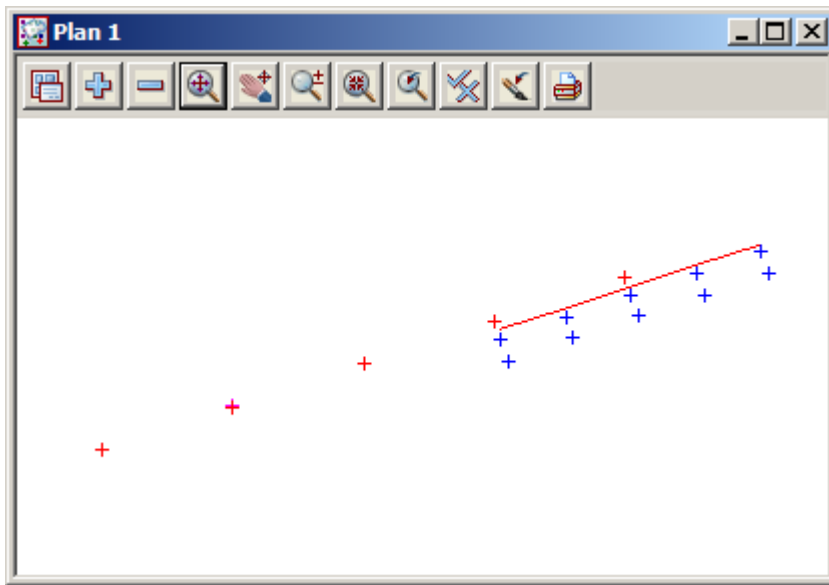

11.7.2 Calculate the differences between the design and as constructed data

Select option **Report=>QA Reports=>Check survey points vs design points (2)**

Select the model **ELEC LIGHT** for the survey model

Select the model **DESIGN LIGHT** for the design data

Type in report name **LIGHTS ASCON**

Type in distance from the design point to look for a corresponding as-constructed point

Select **Chainage-Offset** as the tolerance method

Select the **Chainage String** button then select the alignment string to report the chainages and offsets from

Type in the tolerances in chainage, offset and elevation

Select **Run**

Report file **HTS ASCON.rpt** Open the report file

```

Survey Tolerance Check between survey data and design model <DESIGN LIGHT>
Parameters
Search radius: 0.500
Tolerance Method: Chainage-Offset
Chainage tolerance: 0.050
Offset tolerance: 0.050
Elevation tolerance: 0.030
Results

```

Point ID	Code	Model	Chainage	Offset	Elevation	Distance
254	LP	Survey data	19.989	4.479	205.823	
	LP	DESIGN LIGHT	0.011	0.021	-0.021	0.024
255	LP	Survey data	40.016	4.498	203.226	
	LP	DESIGN LIGHT	-0.016	0.002	0.008	0.016
256	LP	Survey data	60.009	4.521	200.675	
	LP	DESIGN LIGHT	-0.009	-0.021	-0.009	0.023
257	LP	Survey data	79.927	4.610	198.060	
	LP	DESIGN LIGHT	0.073	-0.110	0.038	0.132*
258	LP	Survey data	100.008	4.519	195.518	
	LP	DESIGN LIGHT	-0.008	-0.019	0.012	0.020

```

Summary
Range
High: -0.073 -0.021 0.038
Low: -0.016 -0.110 -0.021
Count: 5 5 5
Mean: 0.010 -0.025 0.006
StdDev: 0.032 0.045 0.020

```

11.7.3 Check asbuilt strings against design strings

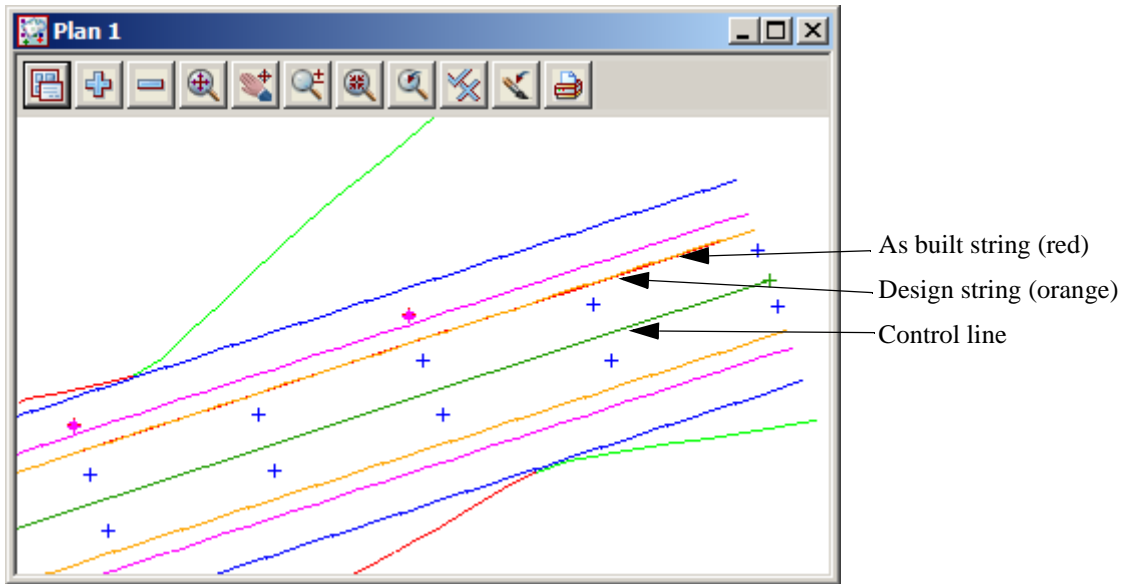

Calculate the difference between the ascon string and the design string

Select option *Report=>QA Reports=>Check asbuilt string vs design string*

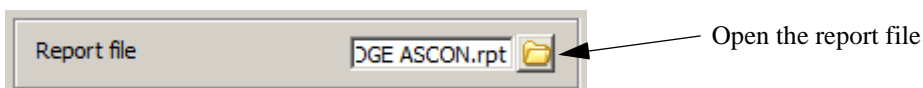
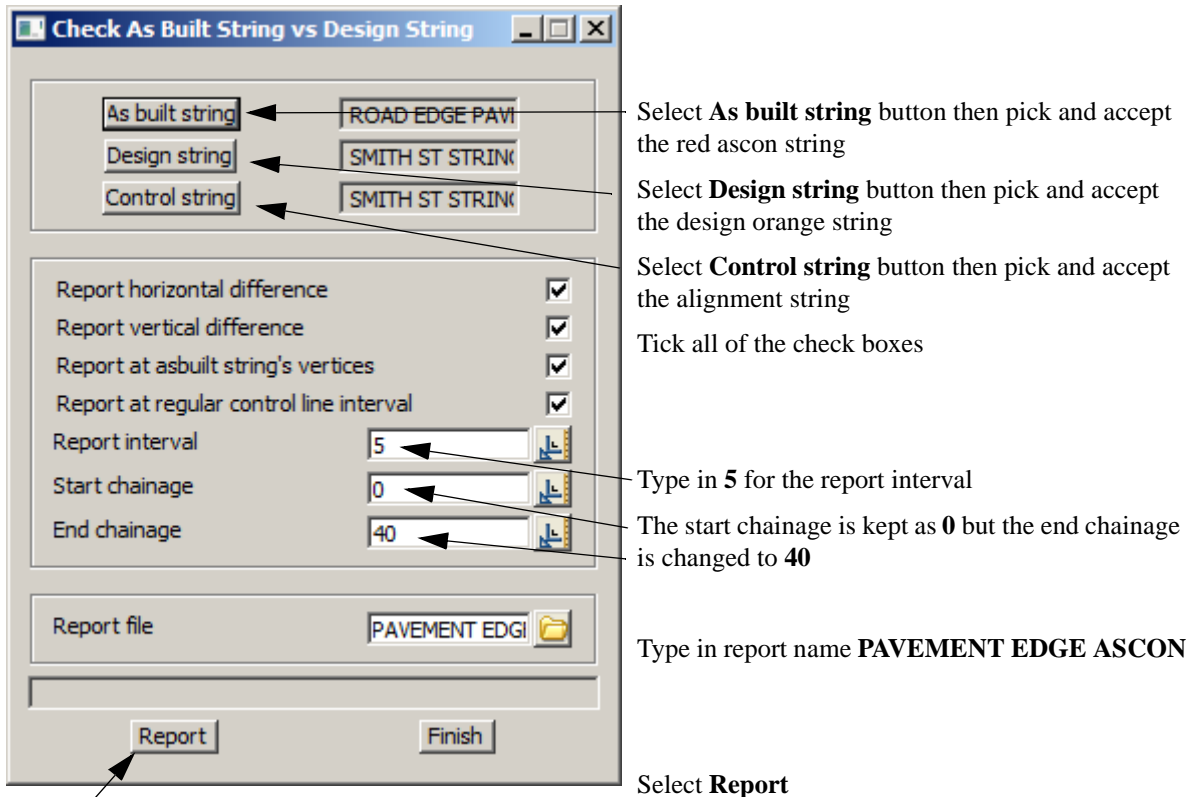

Macro Asbuilt_vs_design_h_z_dif_01

Report file name: PAVEMENT EDGE ASCON.rpt

Check design string using as built string

Design string "SMITH ST STRINGS->eobr" compared to
As built string "ROAD EDGE PAVEMENT->"

Control string "SMITH ST STRINGS->SMITH ST"

Date: Sun Apr 26 11:45:01 2009

Vertical difference is Asbuilt minus Design.

That is, vert diff is positive if Asbuilt is above the Design

At As Built String Vertices:

Relative To CentreLine Chainage	Offset	Asbuilt Coordinates		Asbuilt Level	Design Level	Horz-Diff (mm)	Vert-Diff (mm)
		Easting	Northing				
0.010	3.010	42987.051	37447.856	208.901	208.909	-10.0	-7.7
9.995	2.997	42977.569	37444.726	207.629	207.627	2.8	2.3
20.003	2.998	42968.061	37441.602	206.348	206.342	1.8	6.2
30.037	2.985	42958.533	37438.455	205.049	205.053	15.4	-4.4
39.990	3.011	42949.070	37435.372	203.770	203.776	-11.0	-5.5

At Intervals:

Relative To CentreLine Chainage	Offset	Asbuilt Coordinates		Asbuilt Level	Design Level	Horz-Diff (mm)	Vert-Diff (mm)
		Easting	Northing				
0.000	5358903.782	0.000	0.000	0.000	No cut		
5.000	3.004	42982.312	37446.292	208.265	208.268	-3.6	-2.7
10.000	2.997	42977.564	37444.725	207.628	207.626	2.8	2.3
15.000	2.998	42972.814	37443.164	206.988	206.984	2.3	4.3
20.000	2.998	42968.064	37441.603	206.348	206.342	1.8	6.2
25.000	2.991	42963.316	37440.035	205.701	205.700	8.6	1.0
30.000	2.985	42958.568	37438.467	205.054	205.058	15.3	-4.3
35.000	2.998	42953.814	37436.918	204.411	204.416	2.2	-5.0
40.000	42950.001	0.000	37436.906	0.000	No cut		

11.7.4 Check as constructed points against the design tin

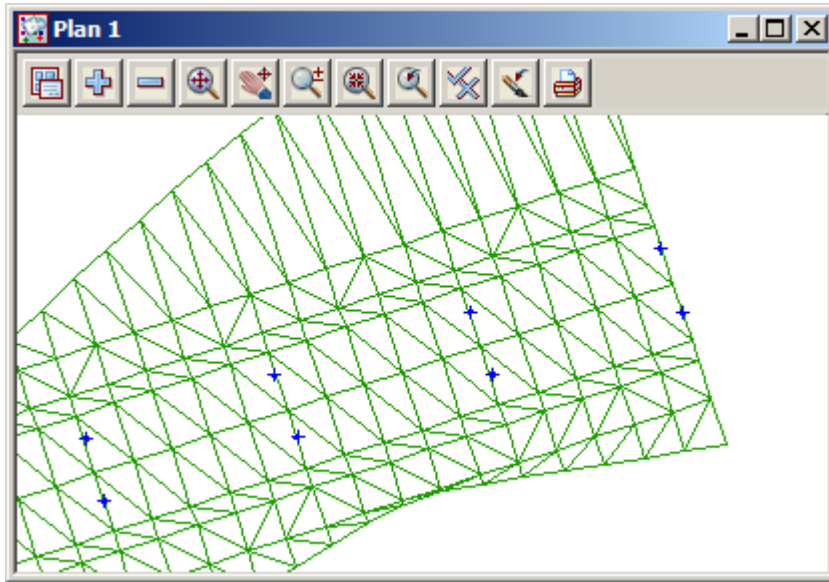

Calculate the difference between the ascon points and the design tin

Select option *Report=>QA Reports=>Check points vs tin*

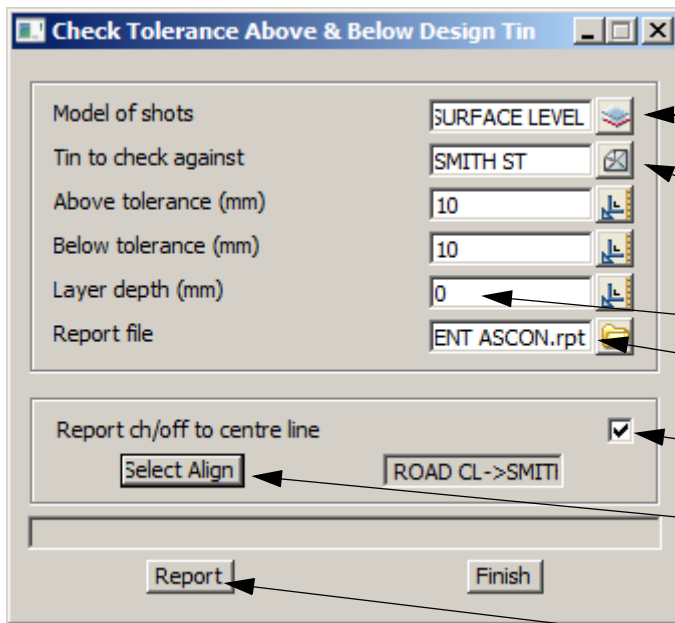

- ← Select **TOPO SURFACE LEVEL** as the model of shots
- ← Select **SMITH ST** tin to check against
- Type in above and below tolerances in mms
- Type in **0** as the layer depth
- Type in report name **PAVEMENT ASCON**
- To reference the points to a control line tick the check box
- Pick **Select Align** then pick and accept the alignment string
- Select **Report**



Open the report file

```

Macro:                Points_vs_tin_z_dif_panel
Report file name:    PAVEMENT ASCON.rpt

Check of Model      "TOPO SURFACE LEVEL"    compared to
  Tin               "SMITH ST"
Centre Line        "SMITH ST"

Above tolerance (mm): 10.0
Below tolerance (mm): 10.0
Layer depth (mm)   : 0.0
Date:              Sun Apr 26 11:51:51 2009

```

Relative To CentreLine Chainage	Offset	As Built Coordinates		Point Level	Design Level	Vert_Diff (mm)	Outside of Tolerance	Name/notes
0.0788	1.8531	42987.3465	37446.7358	208.9393	208.9343	5.0		A
9.9057	1.8026	42978.0267	37443.6191	207.6791	207.6741	5.0		B
20.1088	1.8402	42968.3222	37440.4686	206.3579	206.3629	-5.0		C
29.8502	1.7899	42959.0837	37437.3788	205.1047	205.1137	-9.0		D
39.9858	1.5833	42949.5195	37434.0173	203.8390	203.8185	20.5	10.5 above	
39.9568	-1.7432	42950.5858	37430.8663	203.8094	203.8174	-8.0		
29.9570	-1.4609	42959.9974	37434.2572	205.1168	205.1098	7.0		E
19.9605	-1.4179	42969.4805	37437.4197	206.3966	206.3946	2.0		F
9.8829	-1.4837	42979.0747	37440.5042	207.6766	207.6866	-10.0		G
0.0234	-1.5315	42988.4560	37443.5377	208.9440	208.9510	-7.0		H



12 Subdivision Design

In this exercise we will create a subdivision using a defined outline and explore the various options involved in creating and reporting lot layouts

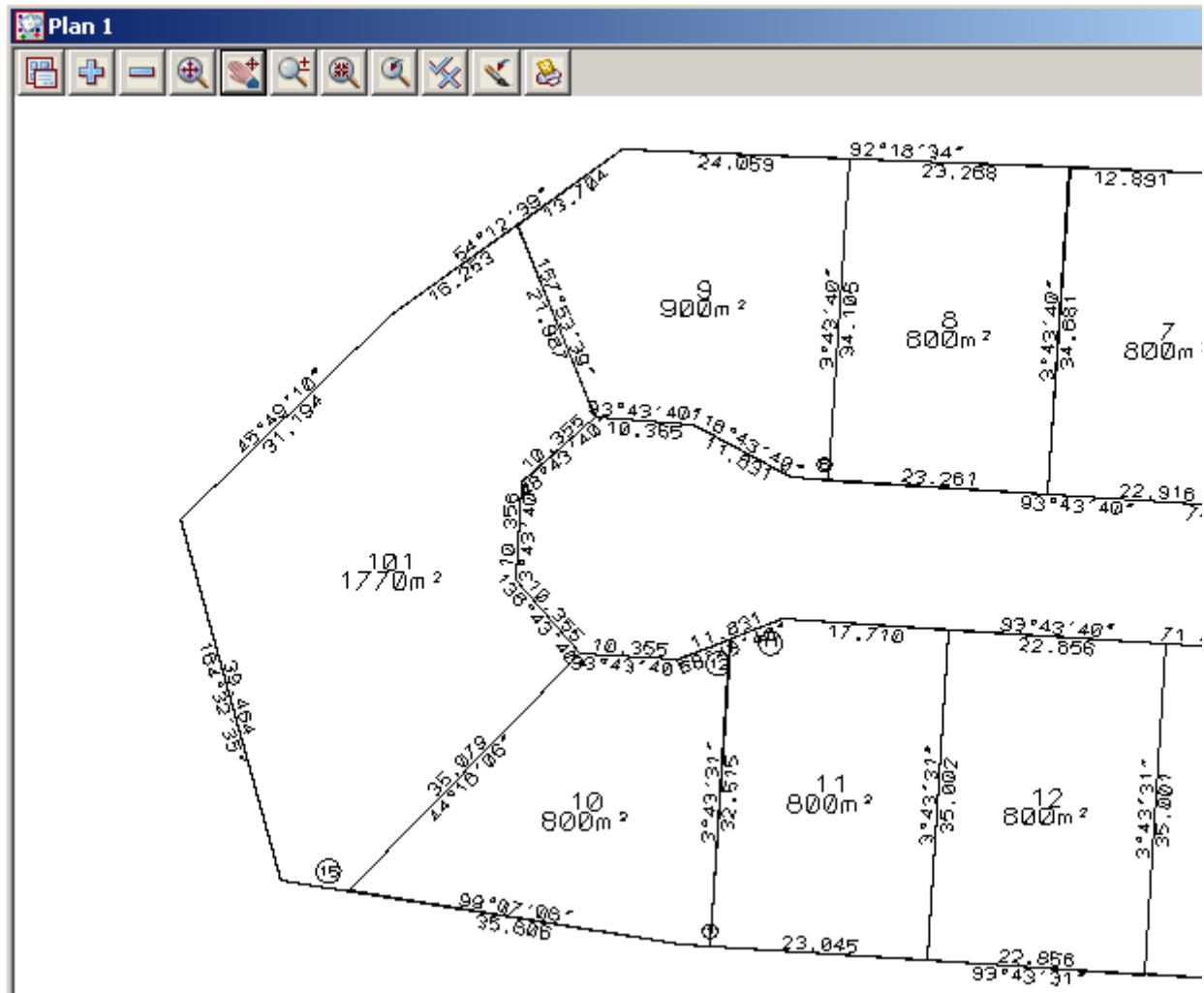

12.1 Setting up a New Project

In this topic we will create a lot outline and position a building on the lot for setout.

To begin create a new project called **SUBDIVISION** in the Survey training area

First, double click on the *12d Model 9* icon to bring up the **Project Selection** panel.

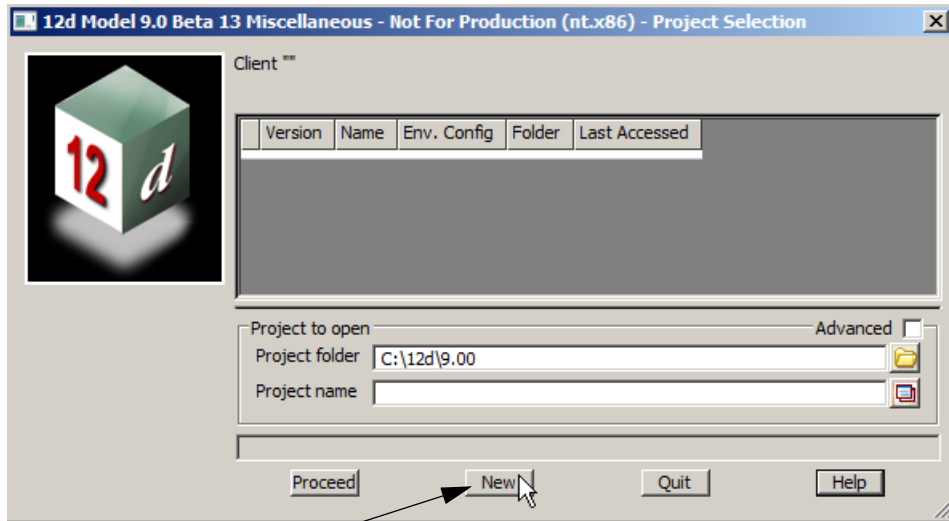
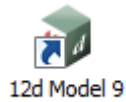

Select **New** button to bring up the **New project** panel.

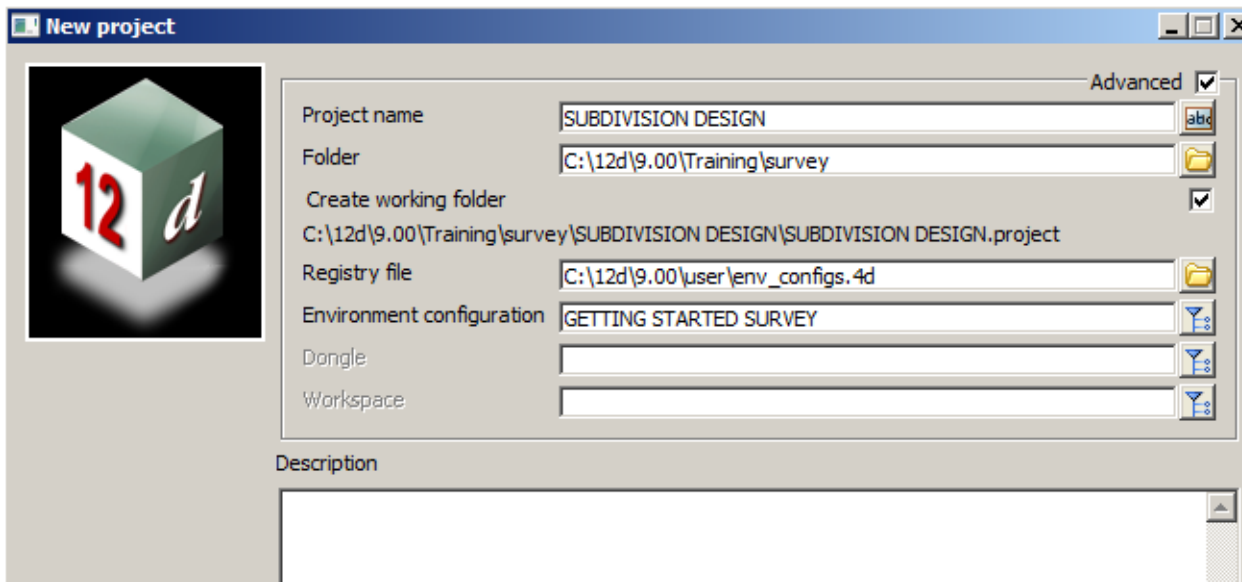

Create a project under the folder **C:\12d\9.00\Training\survey\subdivision** called **SUBDIVISION DESIGN**

With the *Create working folder* check box ticked a working folder with the same name as the project will be also created

Select the Environment configuration **Configurations=>GETTING STARTED SURVEY** which is the one we set up in the previous chapters. If you have gone straight to this chapter you will have to follow the steps in chapter 9.2 to edit the Registry file

Select [**Create**] to create and open the project

12.2 Create the surrounding boundary

We will firstly create the string around the edge of the subdivision

Select option *Survey=>Extras=>Bearing/Distance Entry*

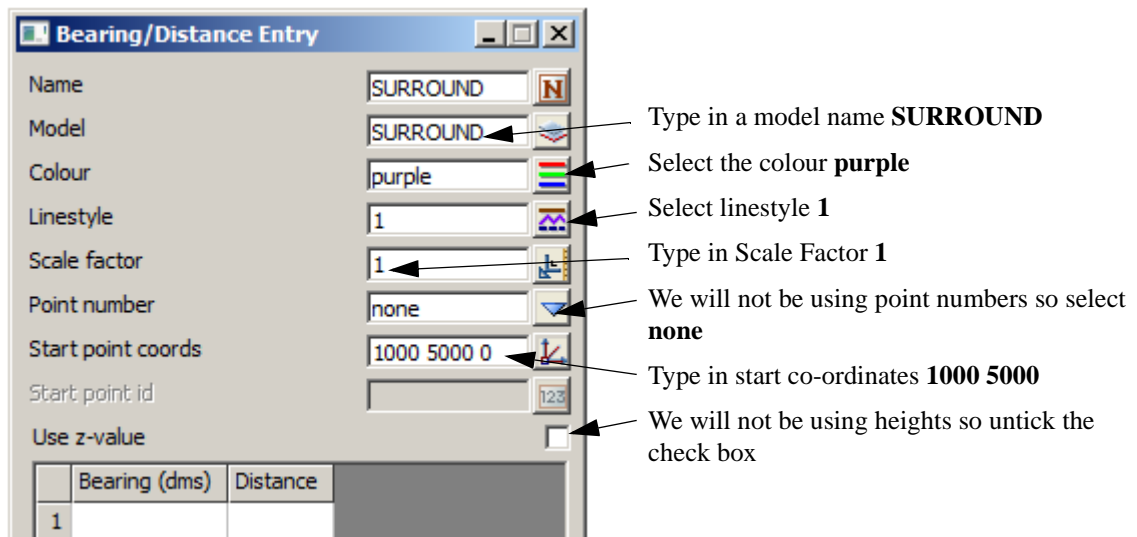

We are now able to type in the bearing and distances around the edge of the boundary

Type in the bearing and distance of the string around the surround boundary

Select the **Enter** or **Tab** key to move between cells.

After typing in the distance press **Enter** to create the next line

Use the bearing and distances as shown in the example on the right

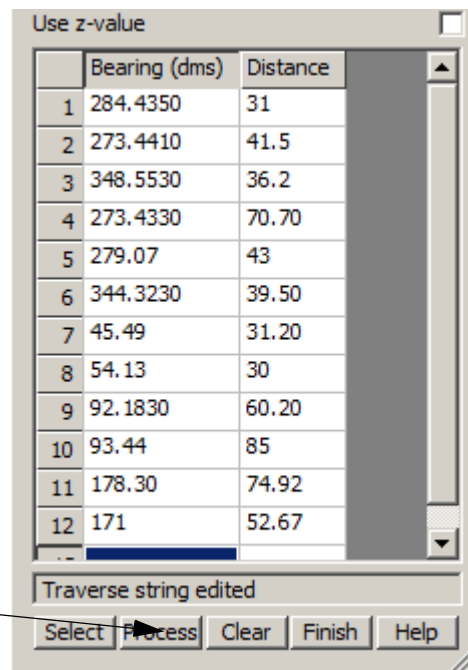

When all lines have been entered select **Process** then **Finish**

Turn on the model **SURROUND** and zoom all

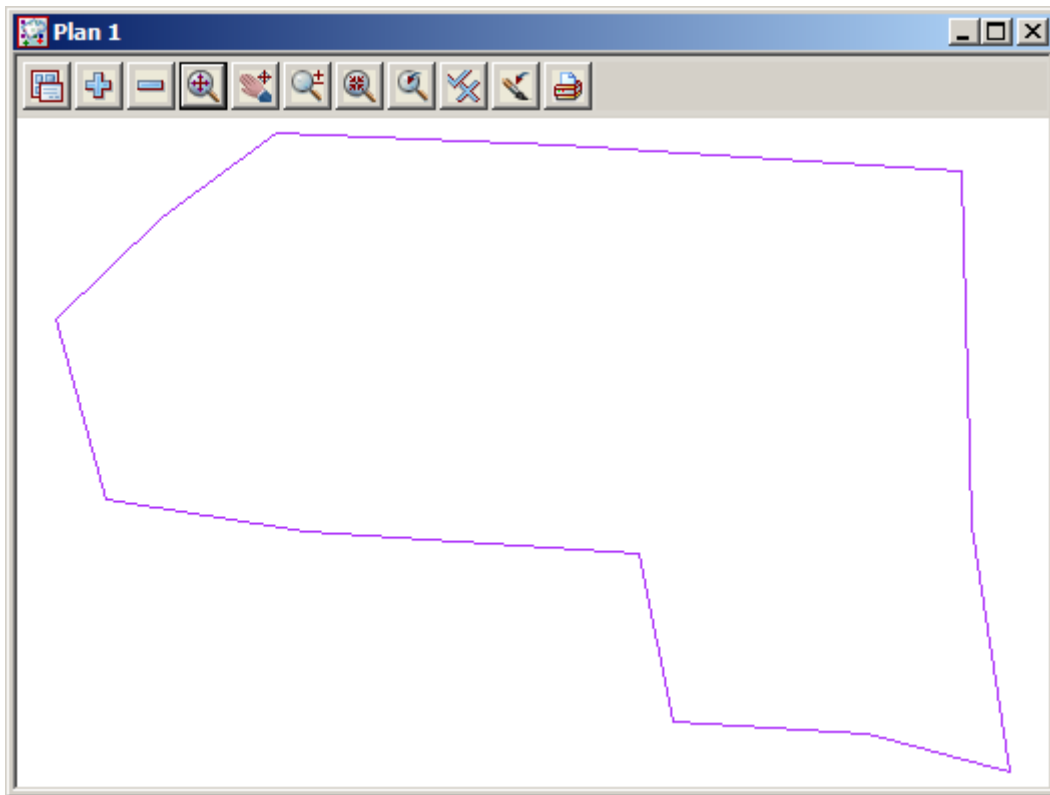
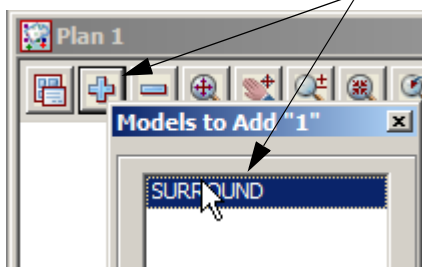

To check the distance between the start and end point select *Utility=>Measure=>Bearing/Distance* or **Measure Bearing/Distance** icon

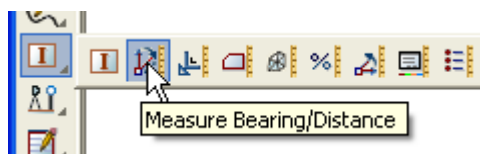

Zoom in to the start point then select and accept the start and end point

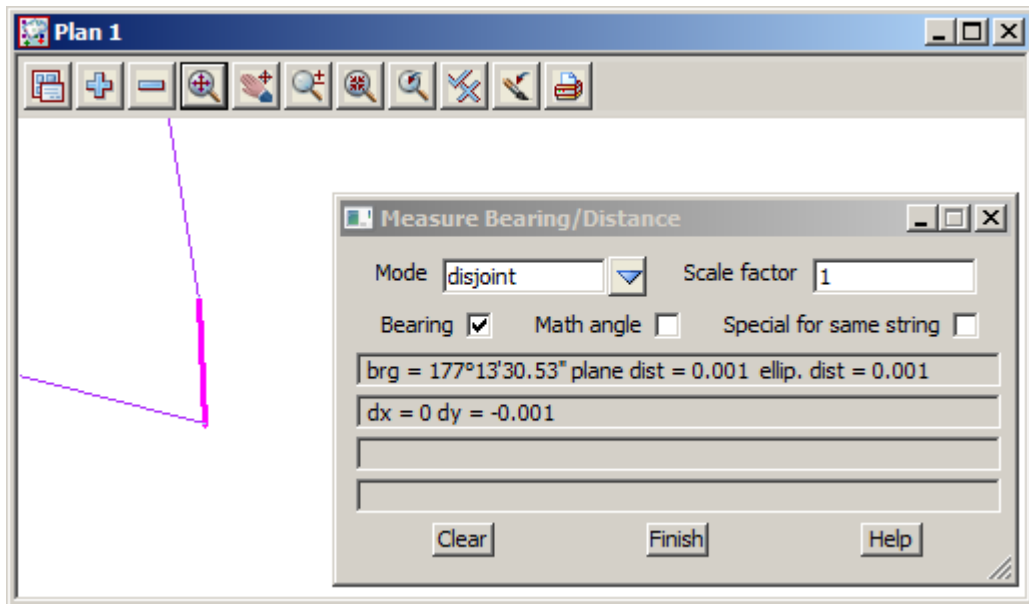

If an error is found the relevant line can be corrected in the **Bearing/Distance Entry** panel and re-processed

Select **Finish** to exit the panel

The string now needs to be closed to form a polygon

Select the option *Strings=>Cad=>Change strings=>Close*

or **String Close** icon

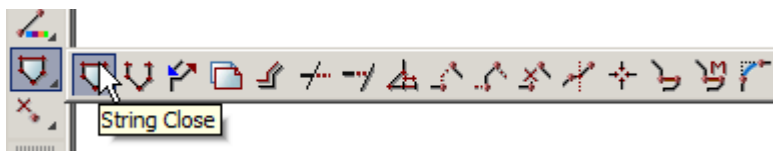

Select and accept the surround string

12.3 Duplicate the surround

The surround string is to be duplicated in a new model called **BDY**. This new model will be used in the subsequent lot calculations

Select *Strings=>Strings Edit=>Duplicate*

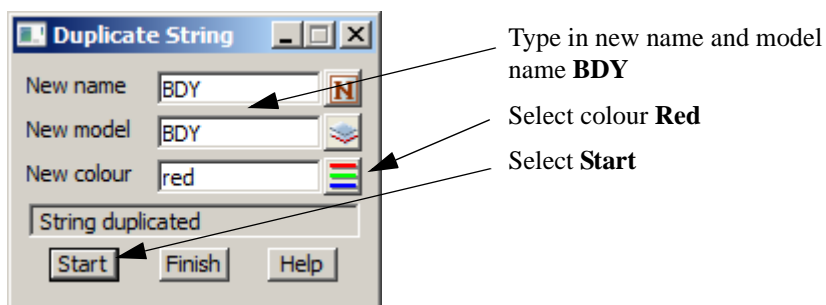

Select and accept anywhere on the surround string

Now turn off the model **SURROUND** and turn on model **BDY**

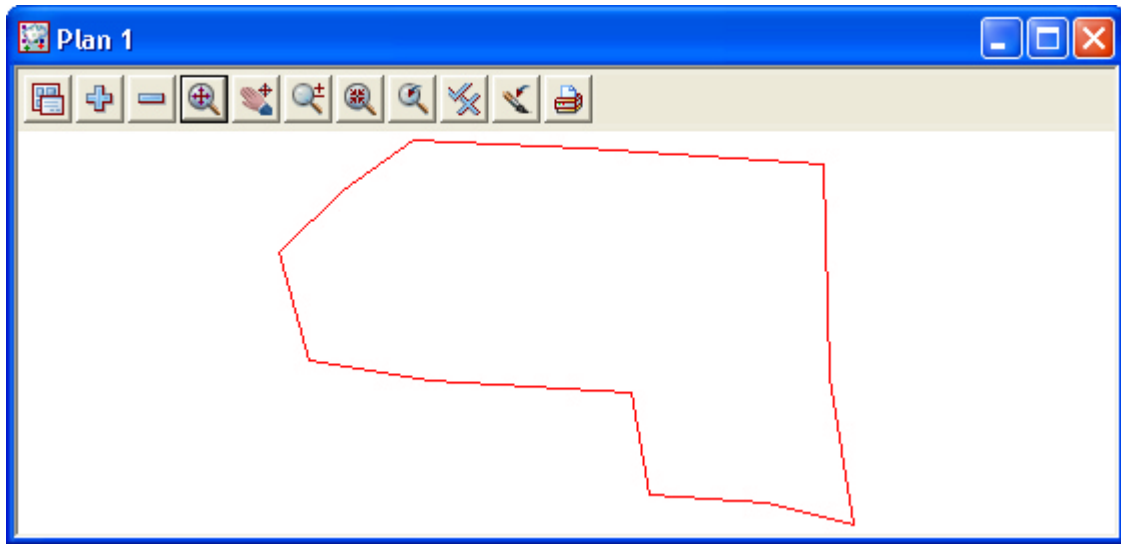

12.4 Open the Boundary string

To help with future calculations using the boundary string we open the string at this point.

Select option *Strings=>Cad=>Change Strings=>Open*

or **Cad string open** icon

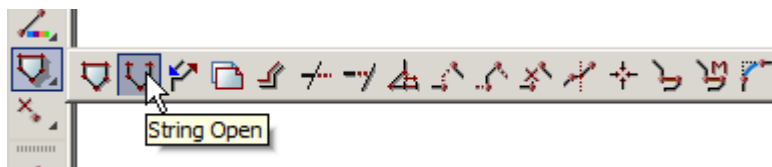

then pick and accept the boundary string

12.5 Create Road Centreline

The centreline of the road reserve will now be created

Type a new model name CL in the cad control bar and change the colour to **blue**

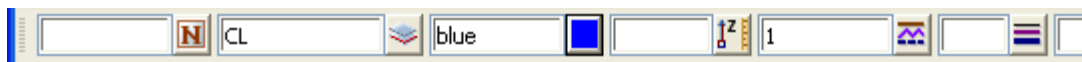

Select the option *Strings=>Cad=>Lines=>Traverse create*

or **Traverse** icon

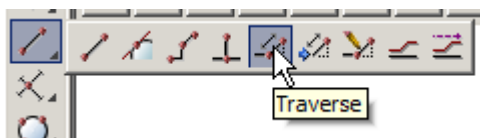

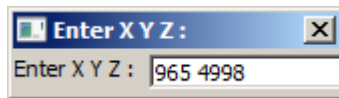

Press the space bar then type in **965 (space) 4998 [Enter]**

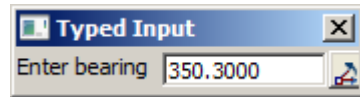

Press the space bar then type in **350.3000 [Enter] 273.45**

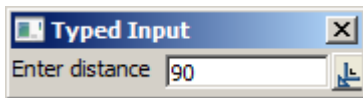

Press the space bar then type in distance **90 [Enter]**

Type in the next bearing as **273.45 [Enter]** and the distance as **103 [Enter]**

Press **[Esc]** key to exit the traverse entry

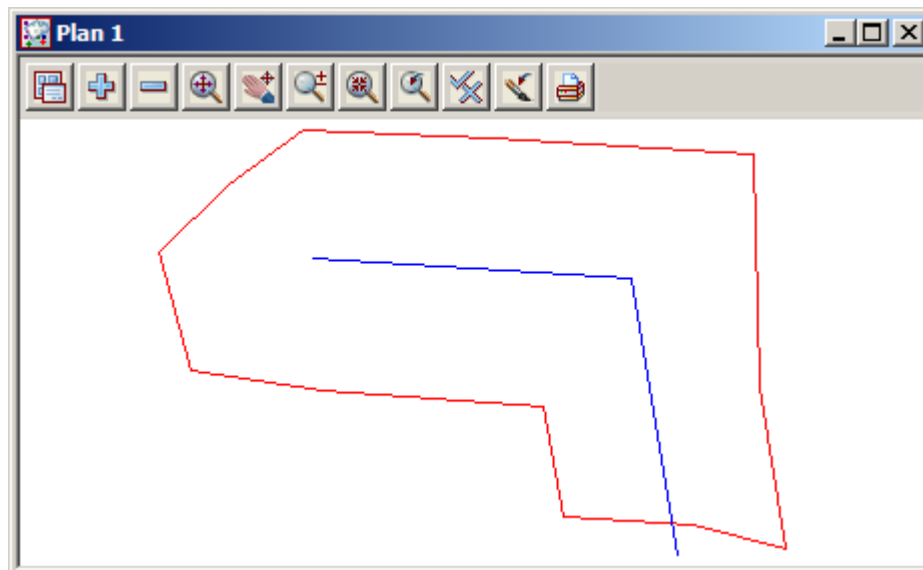

To insert a curve into the centreline string select option **Strings=>Cad=>Change strings=>Join fillet** or select the **String Join fillet** icon

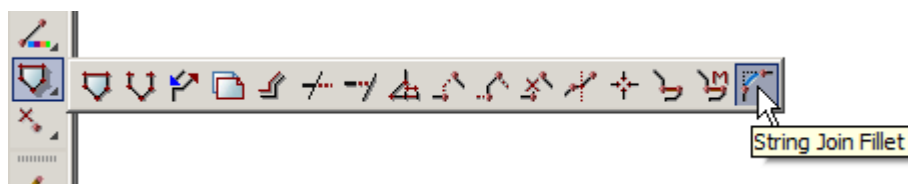

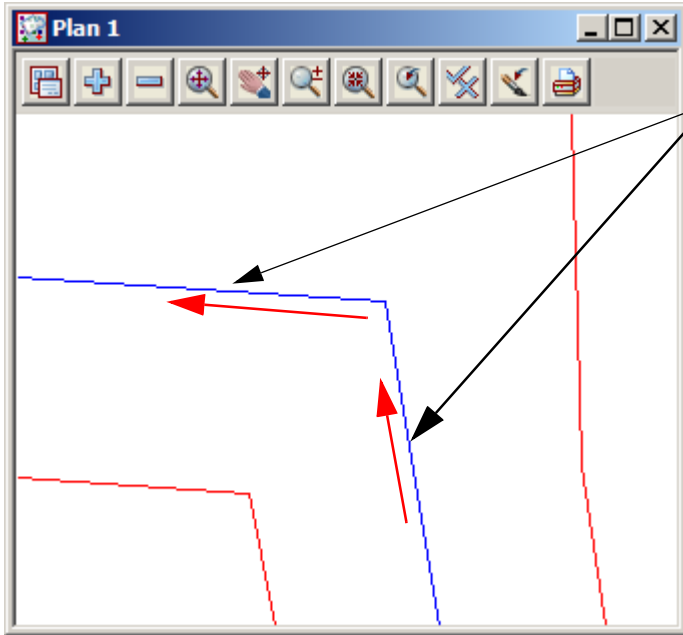

Select up the first straight with direction and accept. Pick along the second straight with direction and accept

Type in the radius **-20** [Enter]

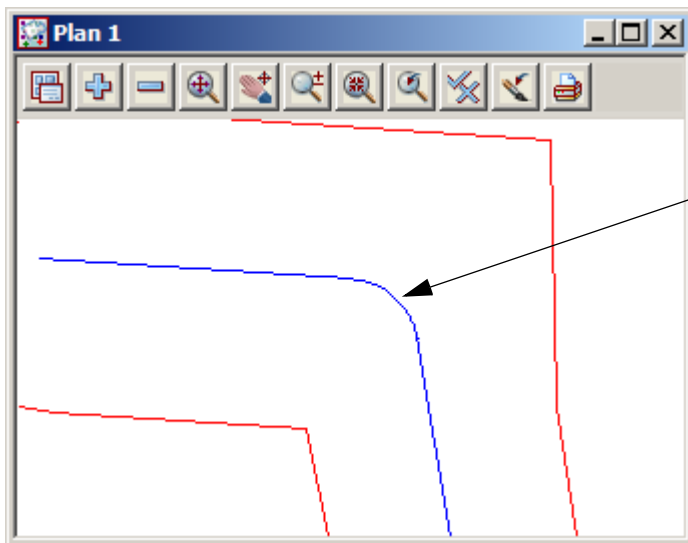
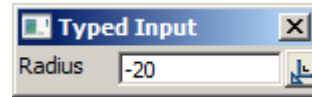

The curve is inserted

12.6 Create Road boundaries

12.6.1 Parallel centreline string

The road boundaries will be created parallel to the road centreline

Set the name and model to **BDY** by matching an existing **BDY string**

Select the **Same as** icon

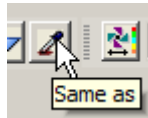

Pick and accept one of the boundary strings

The cad control bar will self populate



Select the **String parallel** icon

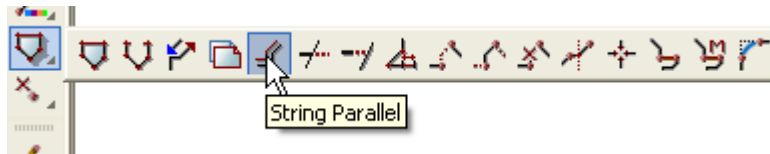

The default parallel type is full (f) parallel

<[Full] Pick string to parallel or type (f)ull, (p)artial> [picks][fast][Menu]

Select the string with direction and accept

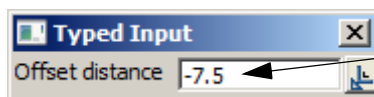
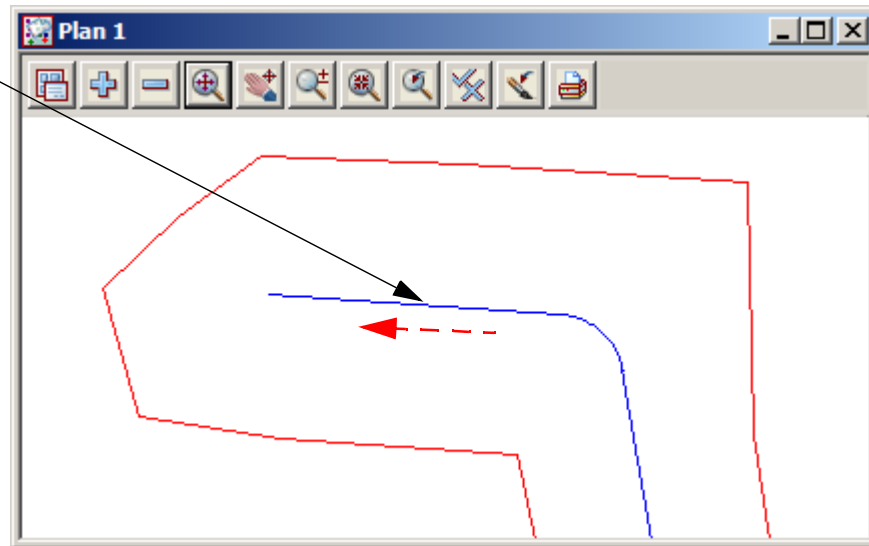

Type in the offset for the left as **-7.5 [Enter]**

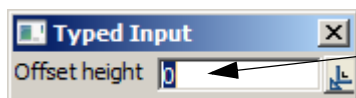

Type in the offset for the height as **0 [Enter]**

The centreline string is
paralleled
Repeat this for the other
side of the road using
offset 7.5

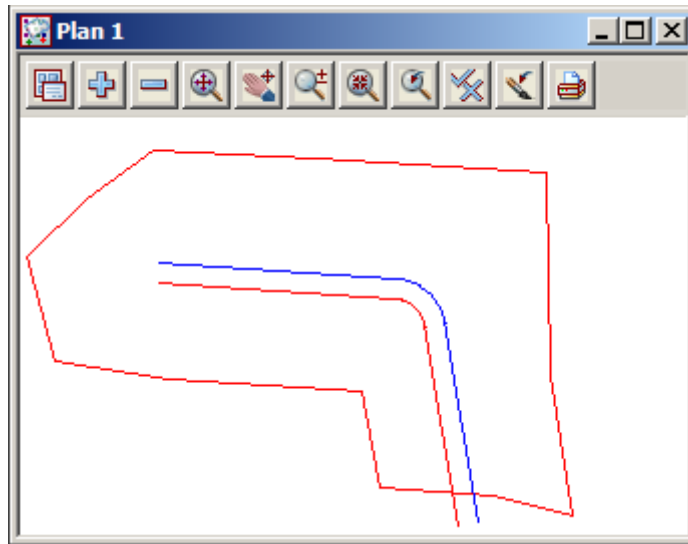

Both sides are paralleled

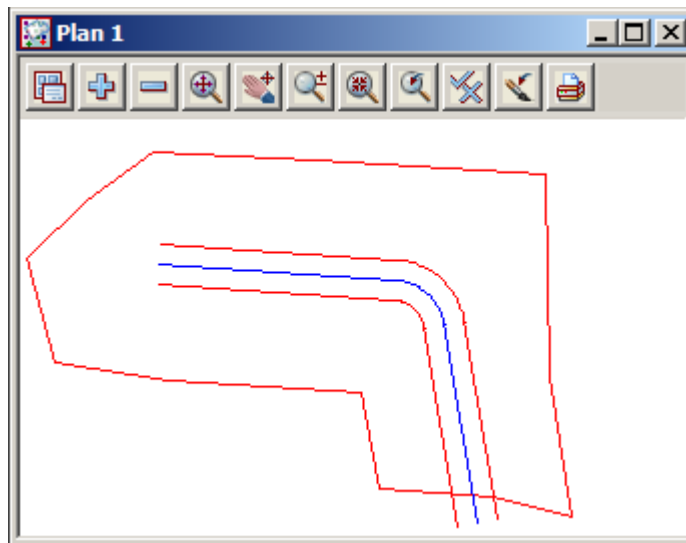

12.6.2 Convert arcs to chords

The arcs along the road boundary are to be converted to chords. These are created on the outside of the right hand curve and inside the left hand curve

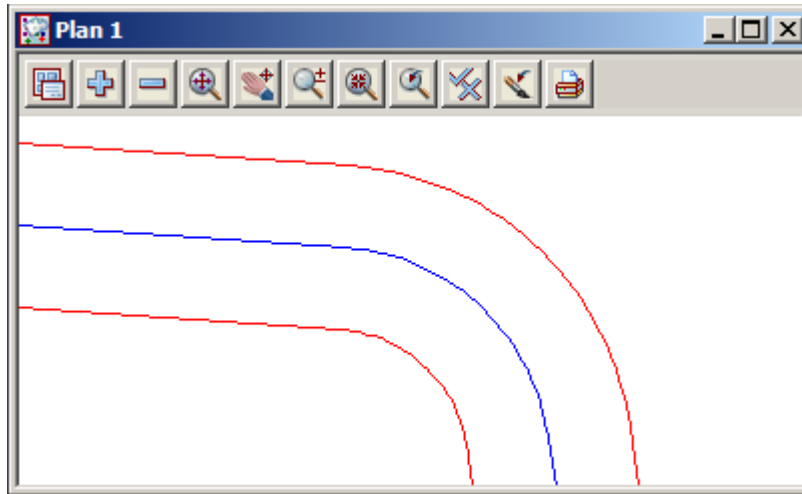

Select the option *Strings=>Strings Edit=>Arc to chords*

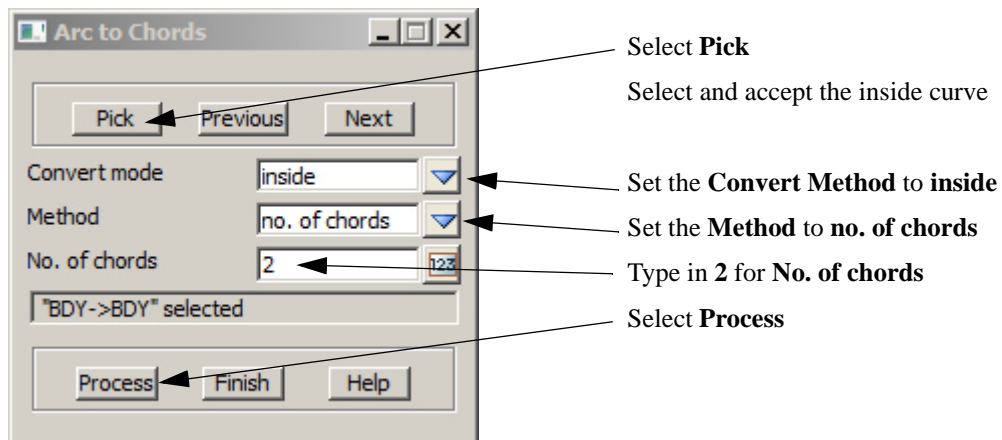

The arc is converted to two chords

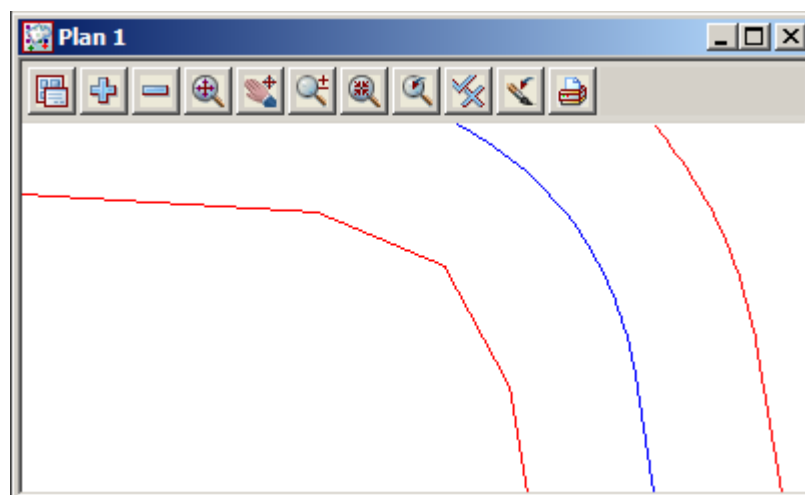

Repeat the process for the outside arc **creating three chords on the outside**

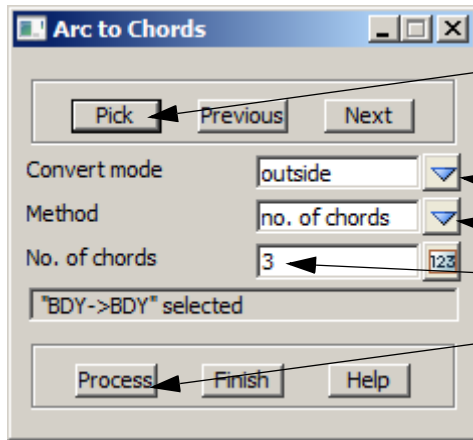

- Select **Pick**
- Select and accept the outside curve
- Set the **Convert Method** to **outside**
- Set the **Method** to **no. of chords**
- Type in 3 for **No. of chords**
- Select **Process**

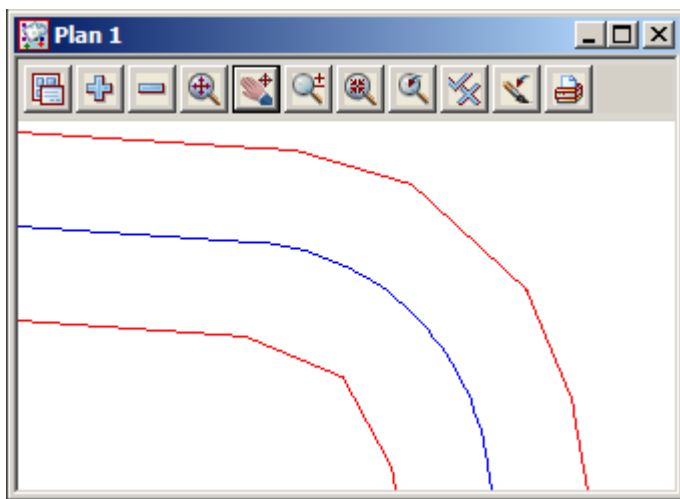

Toggle on the vertices and vertex indices

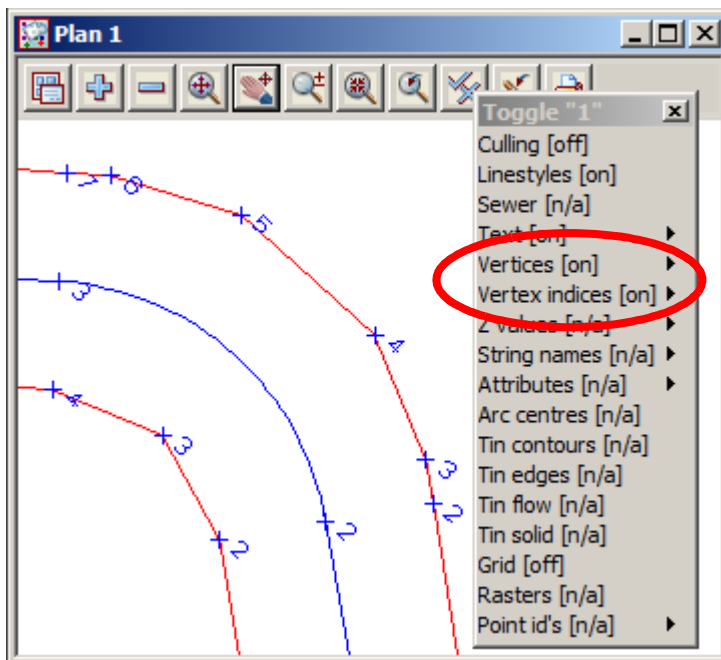

Two vertices are now redundant
 To delete these points select
Strings=>Cad=>Delete=>Points
 or **Vertex Delete** icon

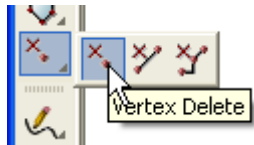

Select and accept the two points

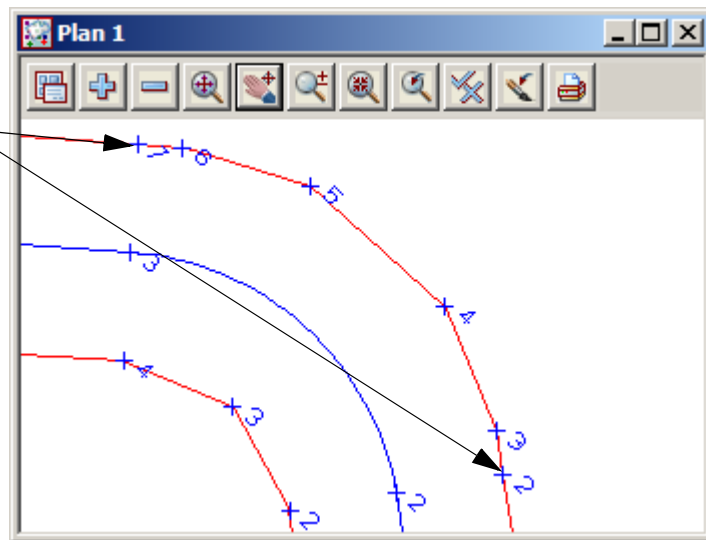

The points are now
 deleted

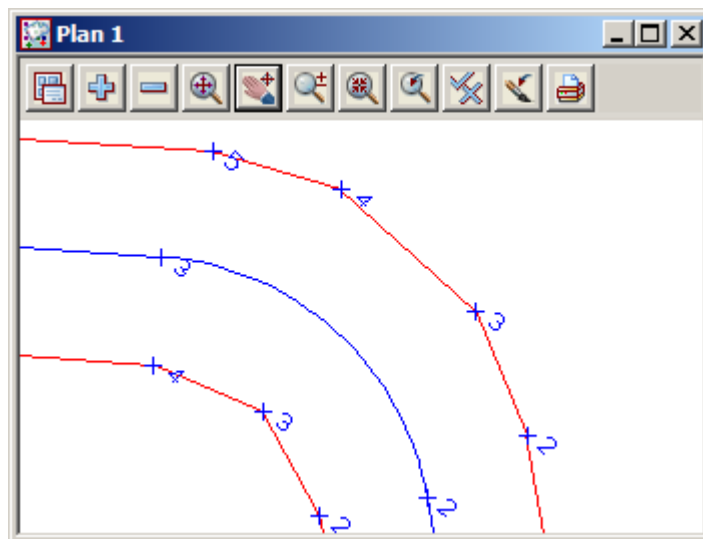

12.6.3 Splay the road intersection boundaries

The road intersection boundaries have to be splayed using 3 chord truncations.

Zoom in to the road intersection

Trim and delete boundary lines

We will use an option to split the strings at the intersection points

Select option *Strings=>Cad=>Change Strings=>Cad Cross Split*

or **String Trim** icon

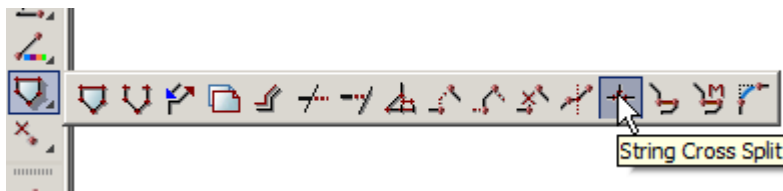

Select and accept the two intersecting lines
Repeat for the other side of the road

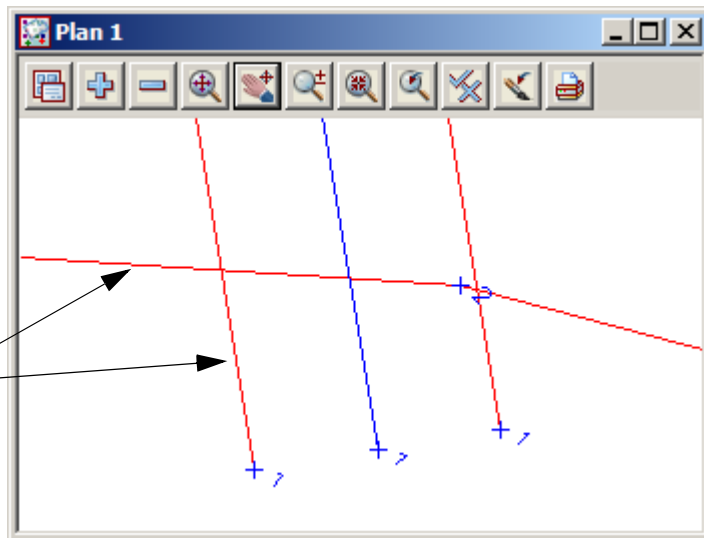

The strings are split at the intersections

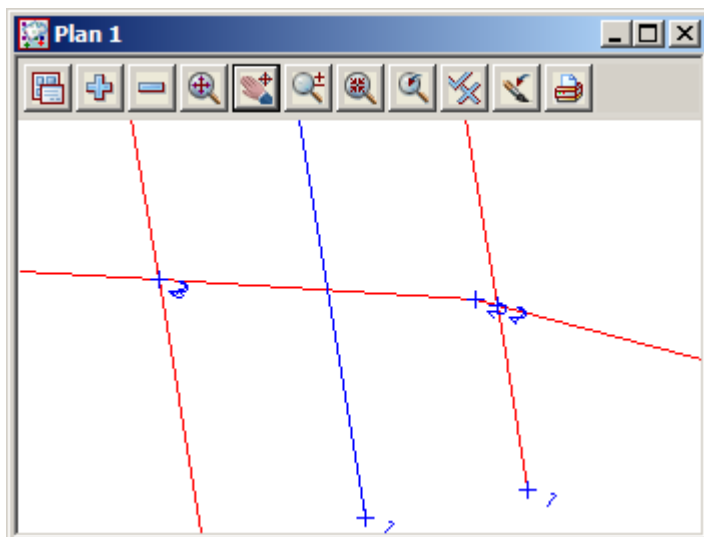

We will now delete the redundant strings

Select option *Strings=>Cad=>Delete=>Strings* or **String Delete** icon

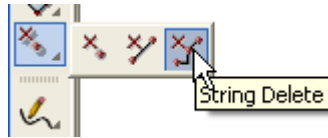

Pick the three strings

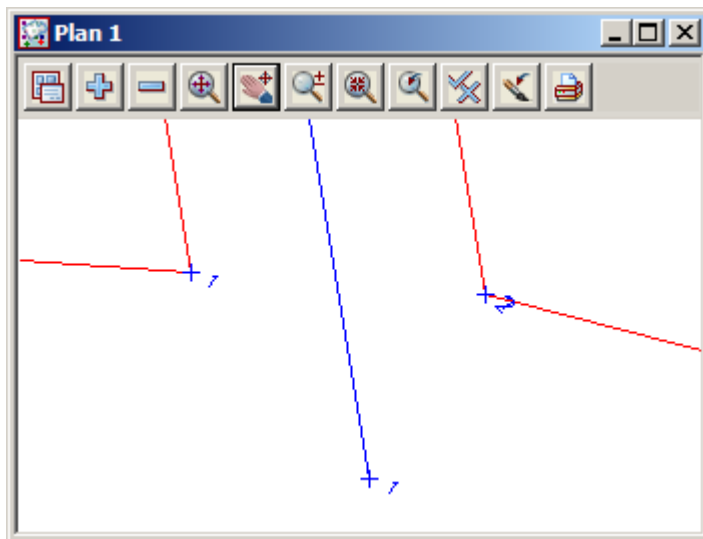
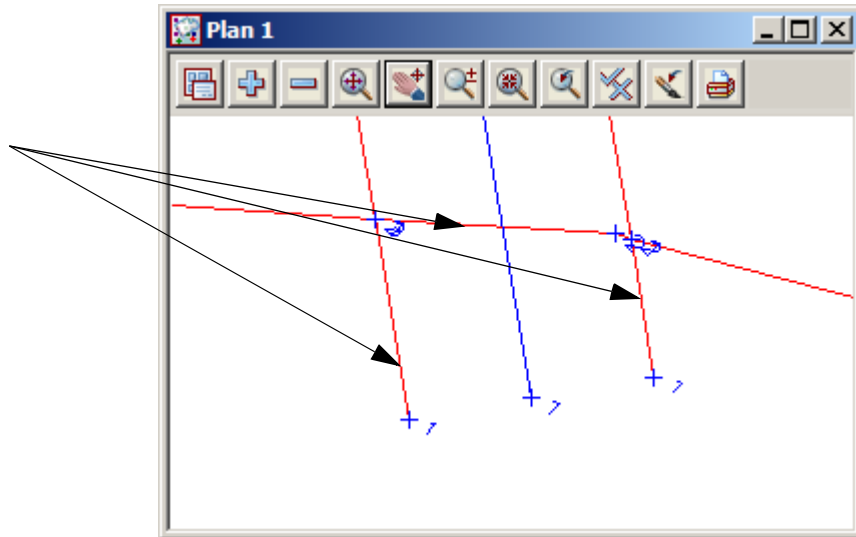

Fillet corners

Before splaying the corners the segments have to be joined to create one string. Filletting the strings with a zero radius will join the strings and remove any duplicate points

Select *Strings=>Cad=>Change Strings=>Join fillet*

or **String Join Fillet** icon

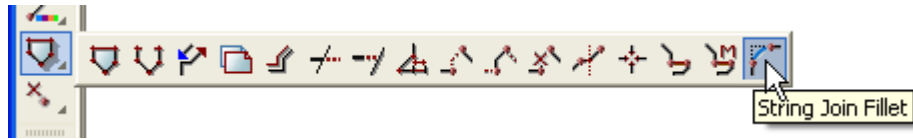

Select with direction and accept the first segment

Select with direction and accept the second segment

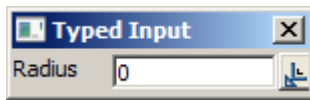

Type in radius 0 [ENTER]

Repeat for the other side

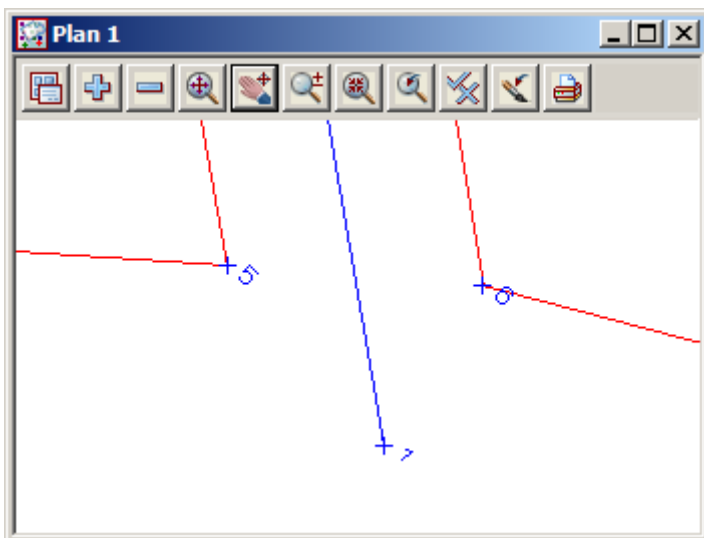
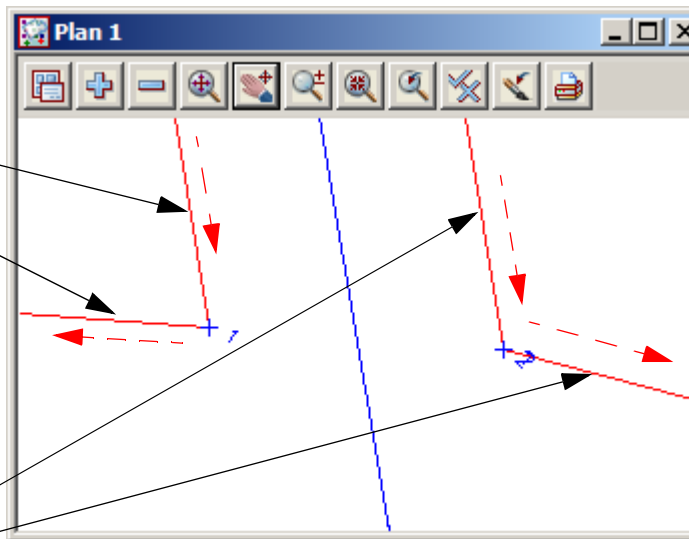

Create corner splays

Select the option *Strings=>String Edit=>Corner Splays*

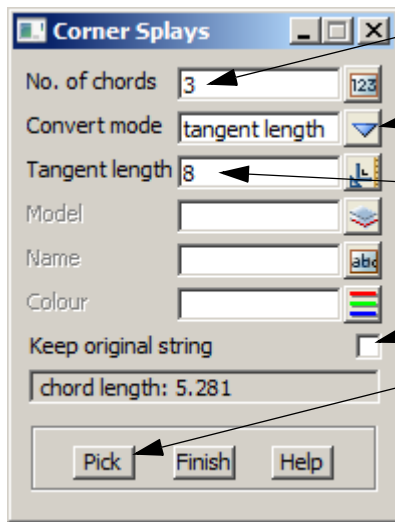

Type in 3 for the number of chords

From the **Convert mode** choice list select **tangent length**

Type in a tangent length of 8

Untick the **Keep original string** check box

Select **Pick**

Select and accept the left side intersection point

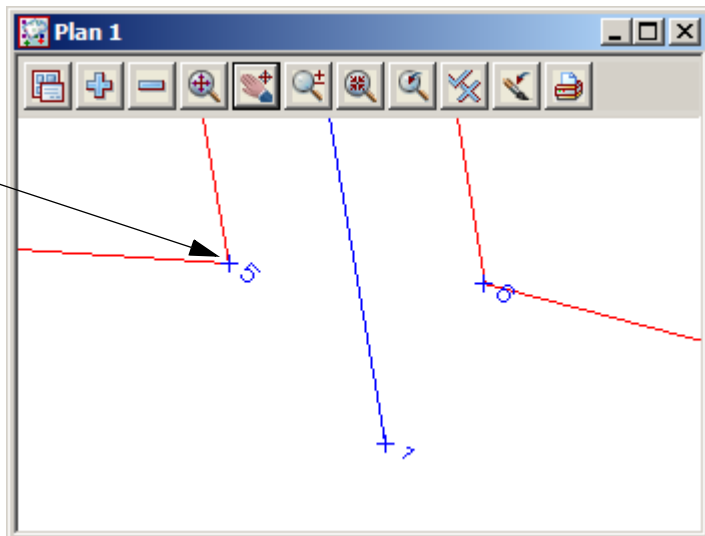

The truncations are created

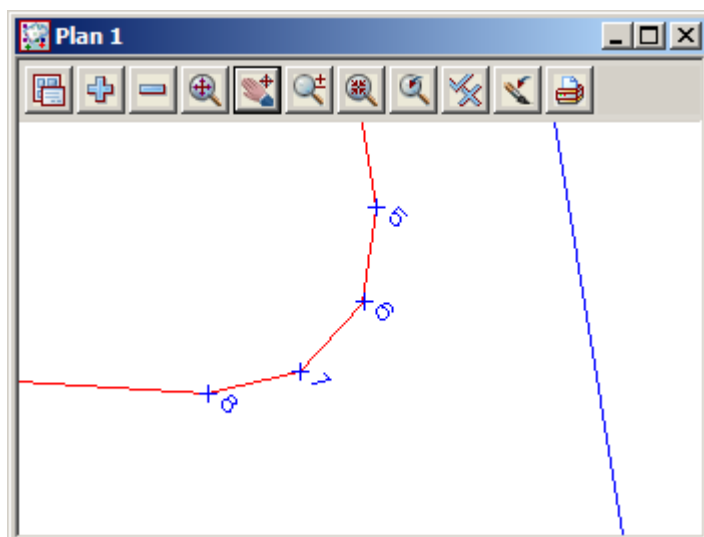

Repeat for the other side of the road

Select **Finish**

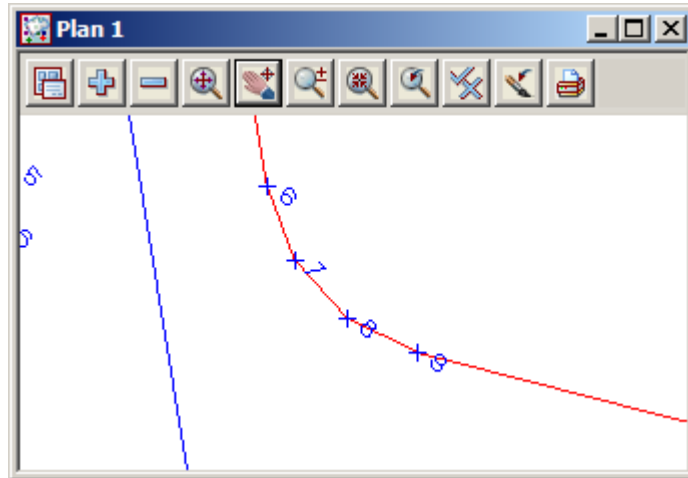

12.6.4 Create Cul de sac head

We will now create a cul de sac head manually. Before continuing ensure the current model is **BDY** and set the default colour in the **Cad Control bar** to **red**



Create Circle

Zoom in to the end of the subdivision road

Select option *Strings=>Cad=>Circles=>Centre, Radius*

or **Centre and Radius** icon

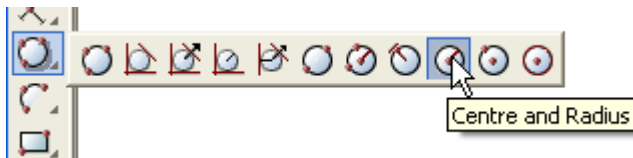

Select and accept the point at the end of the road

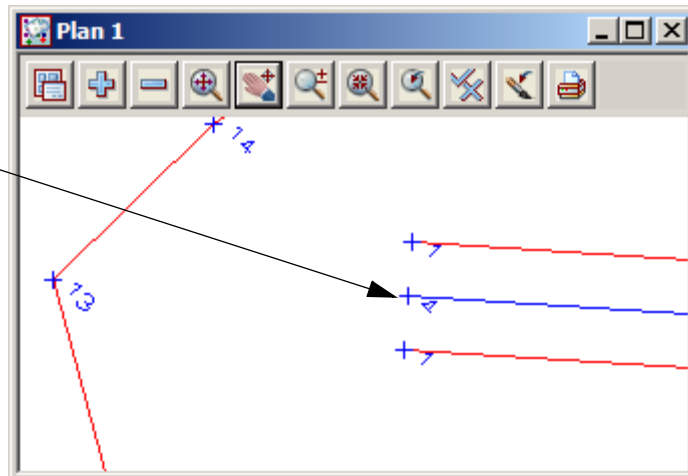

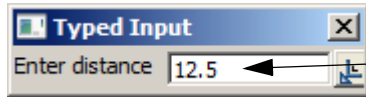

Press the space bar and type in the radius of 12.5 [Enter]

The circle is created

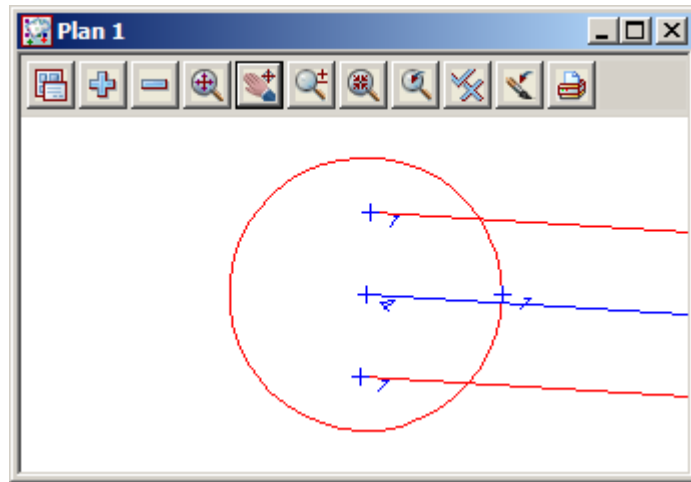

Create boundary lines around cul de sac head

Prior to creating the trapezoid around the circle we need to create an offset point for the orientation of the trapezoid

Select option *Strings=>Cad=>Points=>Offset*

or **Offset** icon

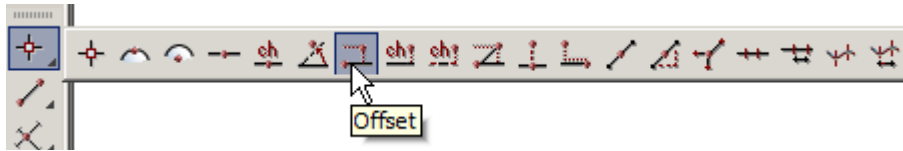

Select top edge of the road boundary string with direction

Select and accept the end point of the string

Type in the distance **0** [Enter]

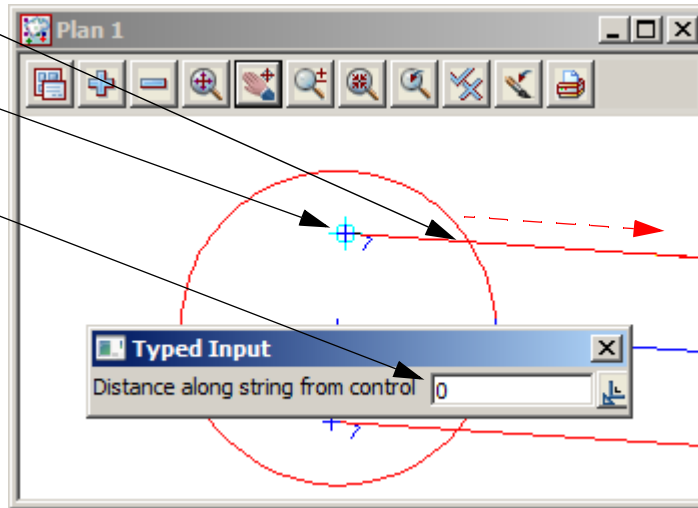

Type in the offset **-5** [Enter]

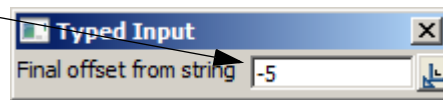

The offset point is created at the edge of the circle

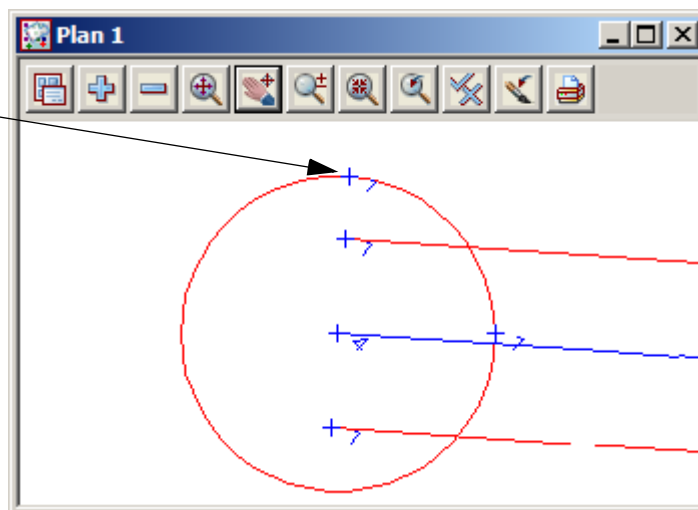

We now create an 8 sided trapezoid about the circle

Select option *Strings=>Cad=>Polygons=>Polygon Circumscribed*

or **Polygon Circumscribed** icon

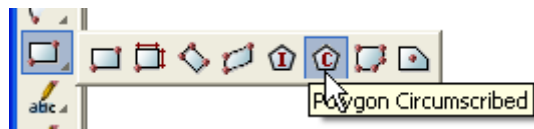

Select and accept the point at the centre of the circle

Type in the number of sides as 8
[Enter]

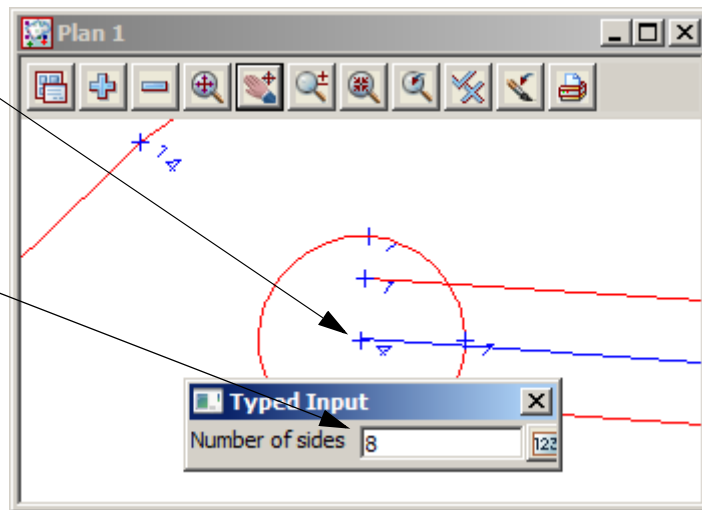

Select and accept the offset point to position the shape

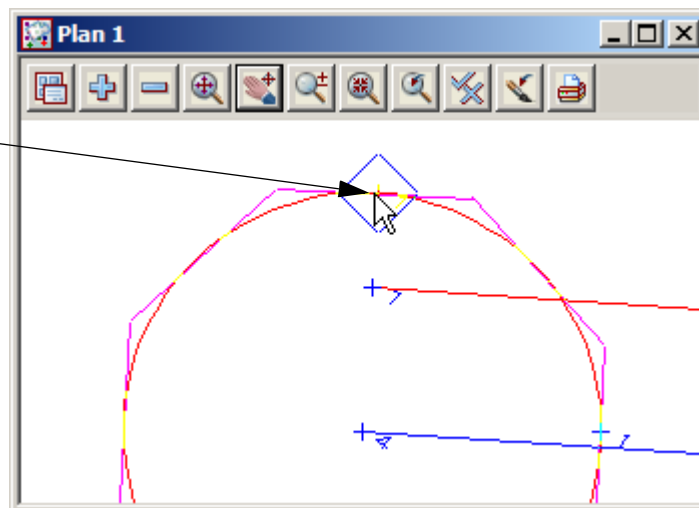

The trapezoid is created around the outside of the circle

Delete the offset point used to create the trapezoid

Select **Vertex delete** icon

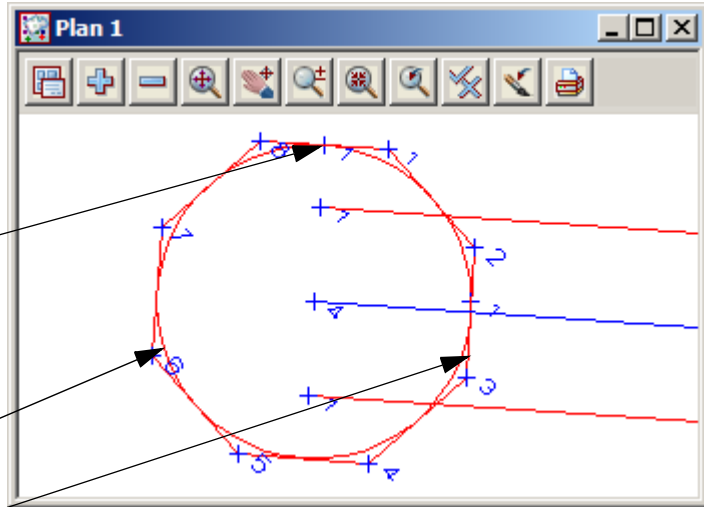
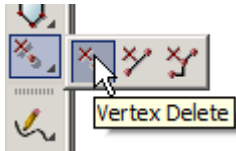

Delete the circle and right segment of the trapezoid using delete options *Strings=>Cad=>Delete Strings* and *Strings=>Cad=>Delete=>Segments*

or **String Delete** icon and **Segment Delete** icon

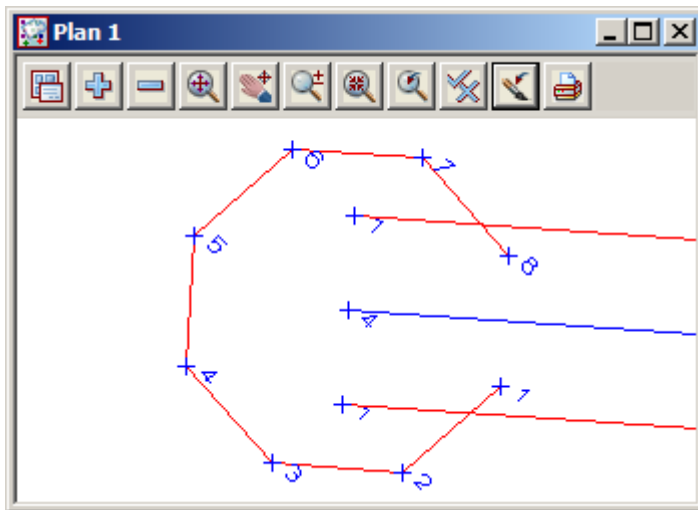
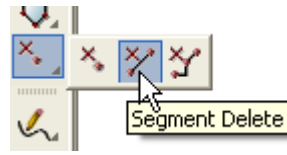
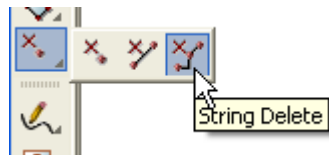

Fillet the trapezoid to the road boundary strings
 Select option *Strings=>Cad=>Change strings=Join fillet*
 or **String Join Fillet** icon

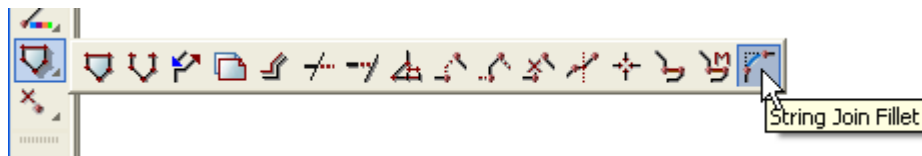

Pick and accept the two strings with direction

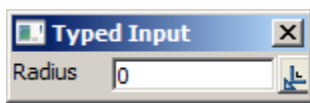

Type in the radius **0 [Enter]**
 Repeat for the lower edge

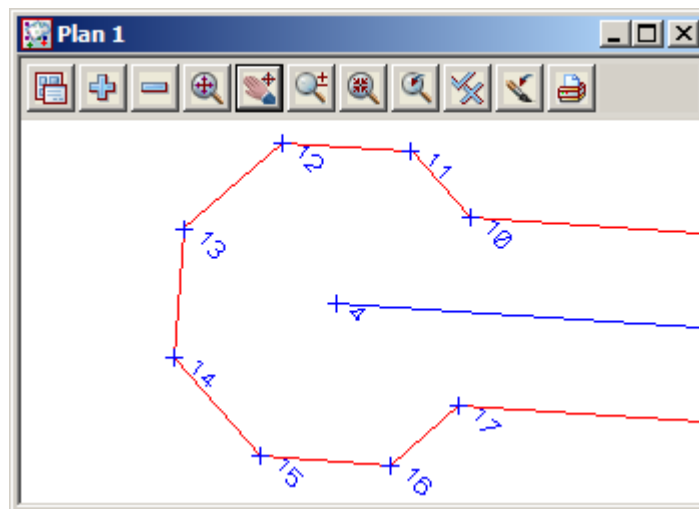
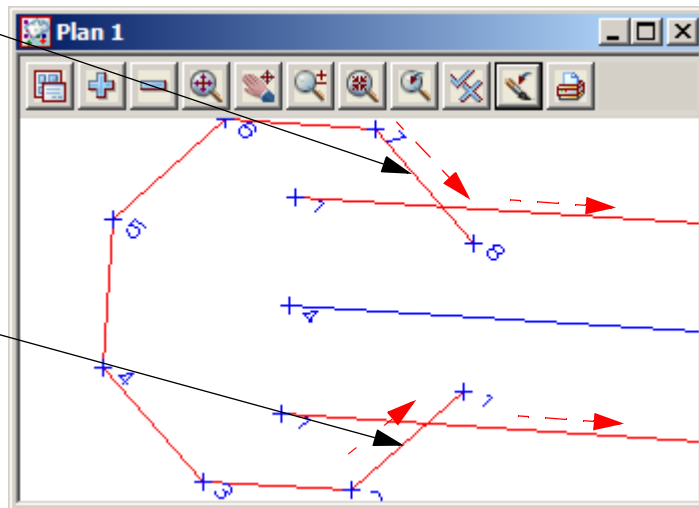

12.7 Create lots

12.7.1 Split string at starting edge

Before we start creating lots the front and rear boundaries should be separated. This is achieved by splitting the string either end of the start and end edges of the lots

Select **Strings=>Cad=>Change Strings=>Split**

or **String Split** icon

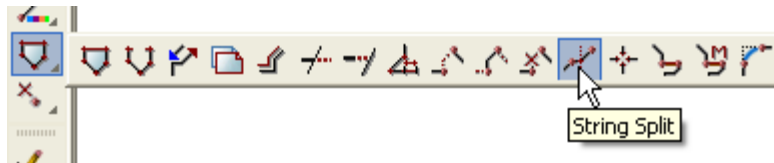

Zoom in to bottom right of the subdivision

We will split the string at vertex 2, 24 and 25

Select and accept string from 1 to 2

Select and accept point at vertex 2

Select and accept string from 24 to 25

Select and accept point at vertex 25

Repick previous string then select and accept point at vertex 24

Select **Finish** on panel

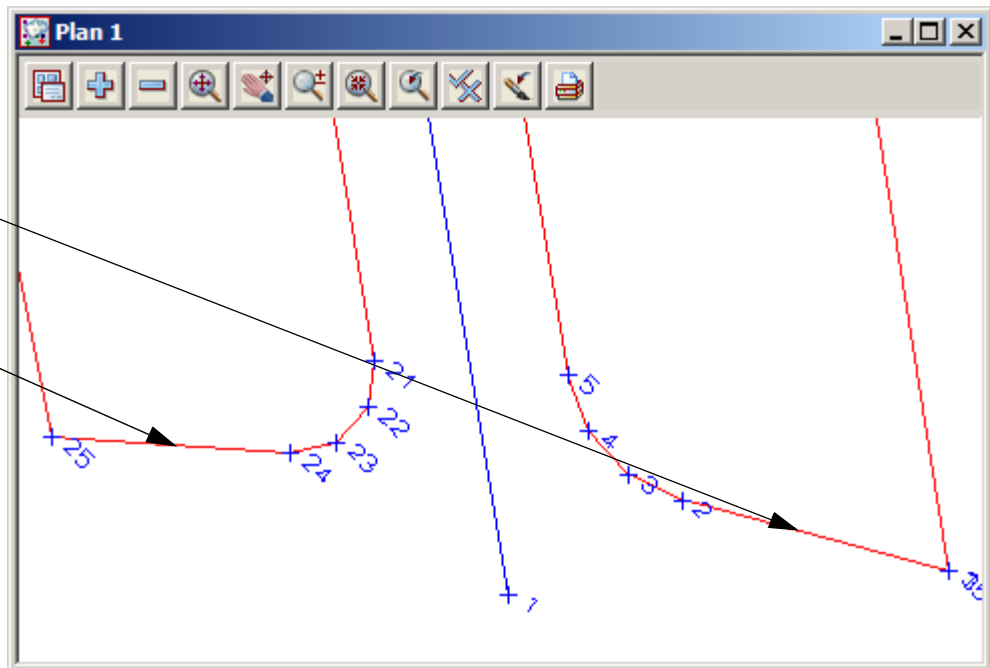

Toggle off the vertex numbers

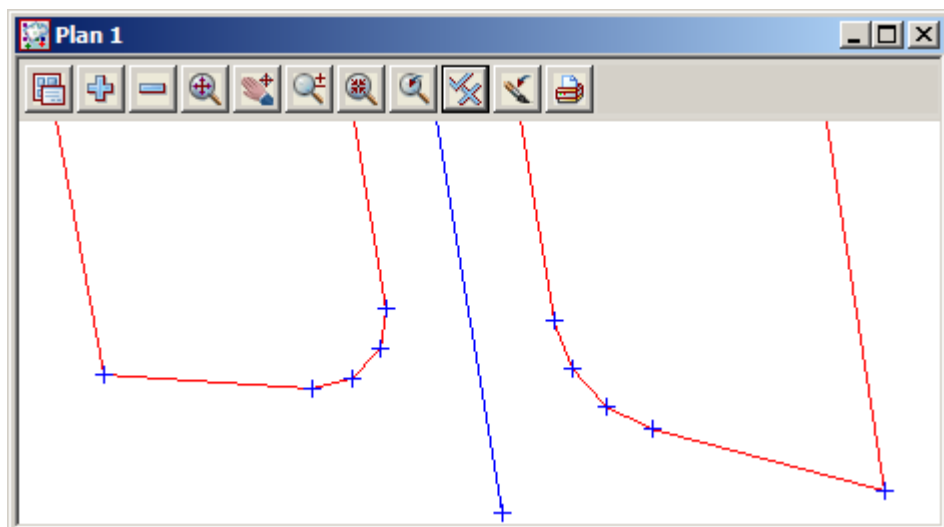

12.7.2 Create lots by different methods

The first three lots will be created by specifying a minimum area for the new lots

Select option *Design=>Estate/Lots=>Create lots=>Create lots*

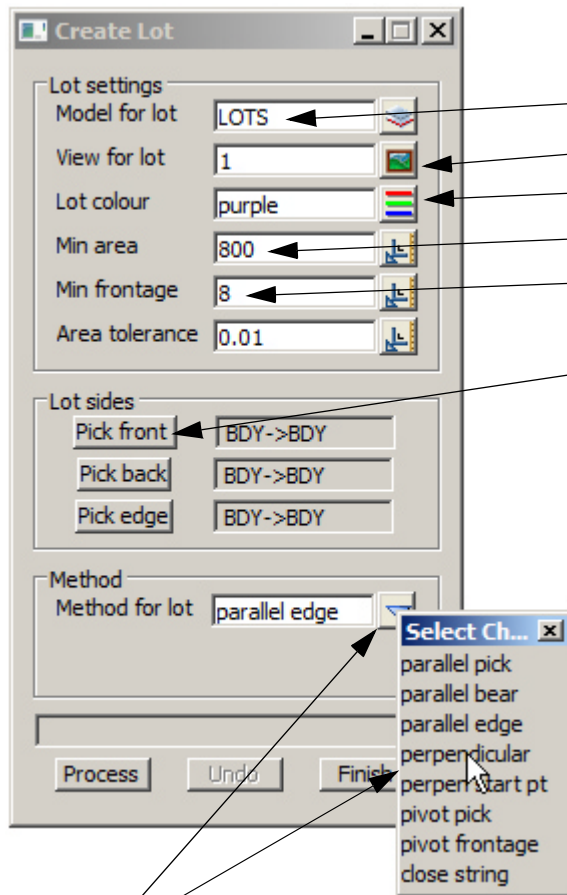

Type in model name **LOTS**
 Select view **1**
 Select colour **purple**
 Type in **800** as minimum area
 Type in **8** as the minimum frontage

Select **Pick front** and select and accept the front boundary string with direction

Select **Pick back** then select and accept the rear boundary string with direction

Select **Pick edge** then select and accept the start edge

Select **Method for lot** choice icon then select **perpendicular**

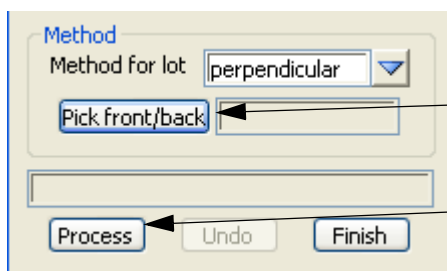
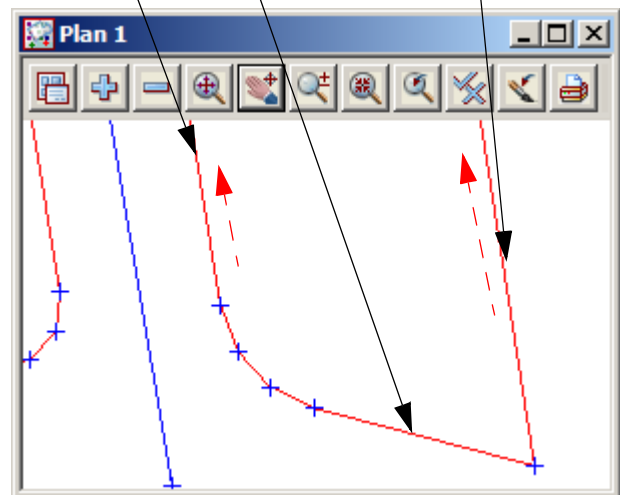

Select **Pick front/back** then select and accept the front boundary line. Pick somewhere along the main along away from the corner splays

Select **Process** to create lot

The first lot is created with the new edge perpendicular to the road frontage

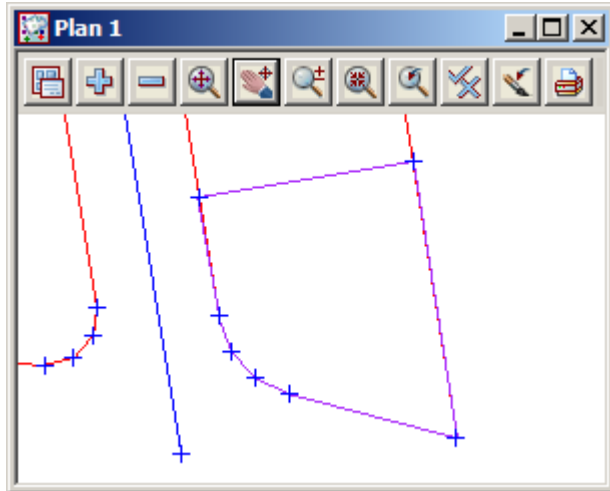

Now change the **Method for lot** to **parallel pick**

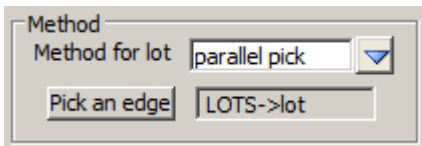

Select **Pick an edge** and select the previously created lot edge

Process again

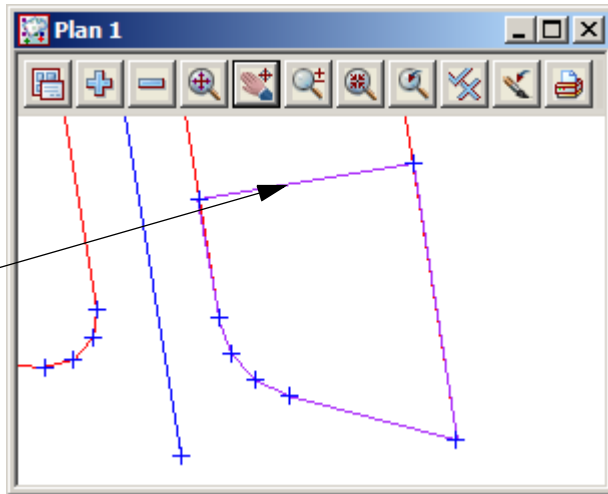

A second lot is created

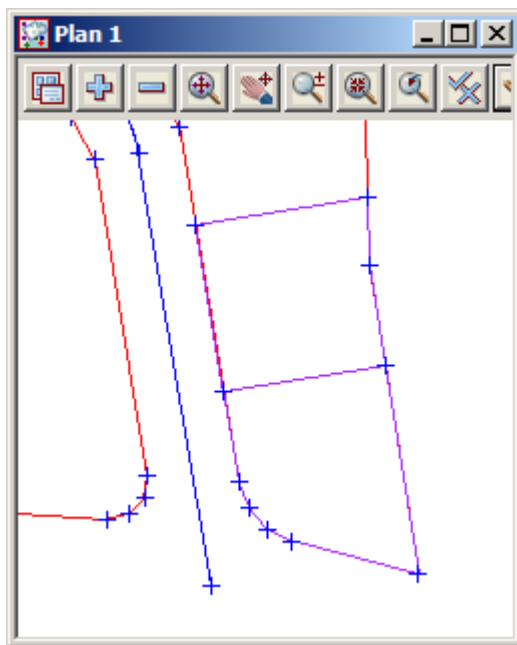

Select **Process** again

The third lot is created

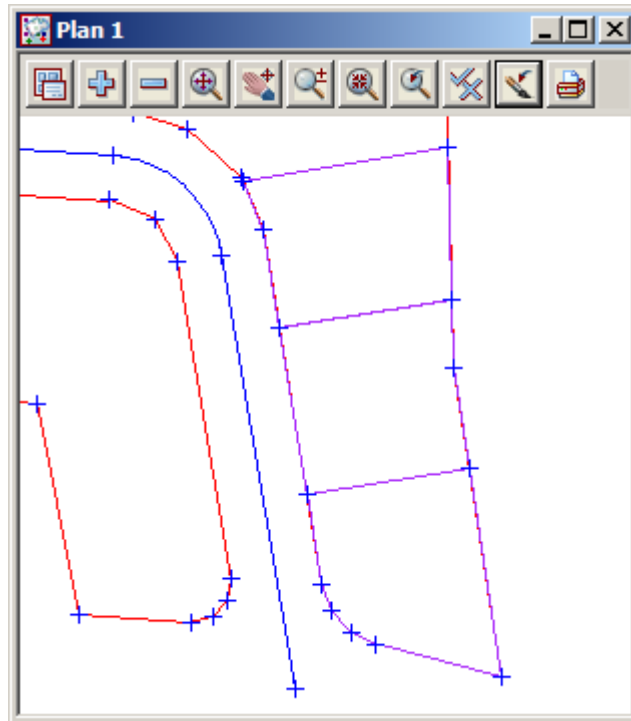

The next lot to be created will not have a minimum area but will have a new edge bound by two existing vertices on the front and rear boundaries. We will use a new option to create this lot.

Minimise the **Create Lot** panel

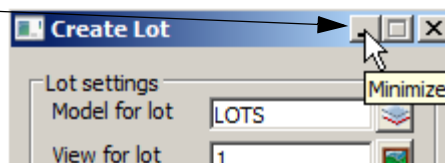

Pan up to the top right of the subdivision

The new boundary edge will be created from the shown vertices

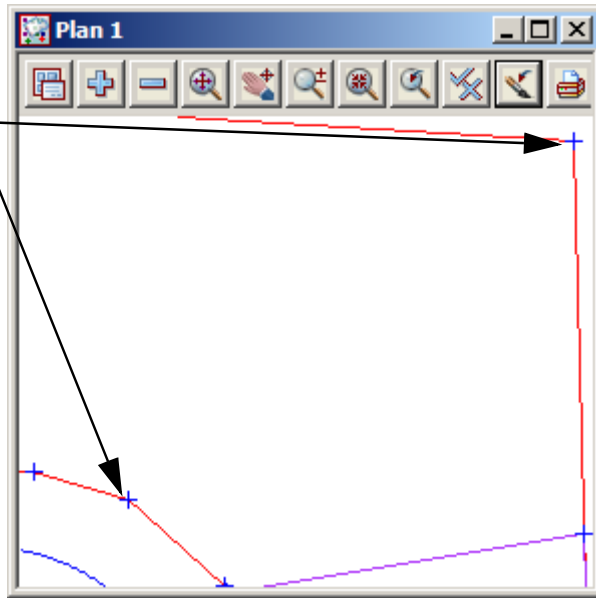

Select option *Design=>Estate/Lots=>Create lots=>Create lots by picking segments*

Select model **LOTS**

Select colour **purple**

Tick the check box to **Join first and last segment**

Select **Pick sides**

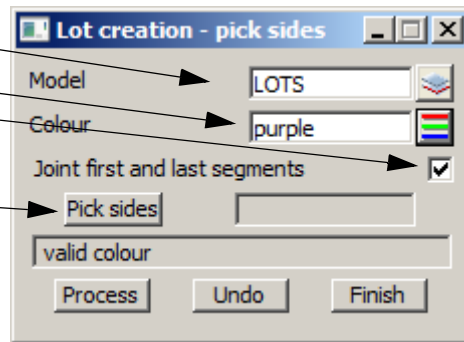

Pick and accept the segments with direction clockwise from top right vertex

Take care to zoom into the small segment at the front

The **no. of segments:** is shown

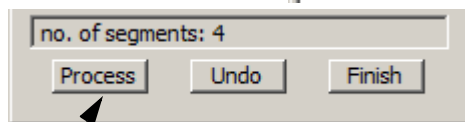

Select **Process** to create lot

Select **Finish** to exit

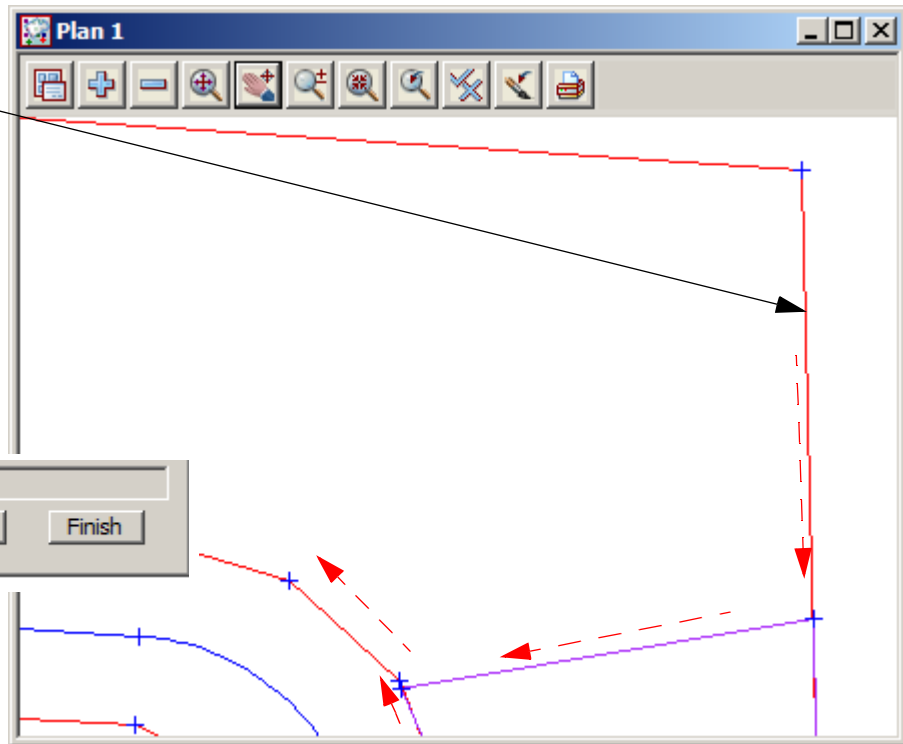

The new lot is created

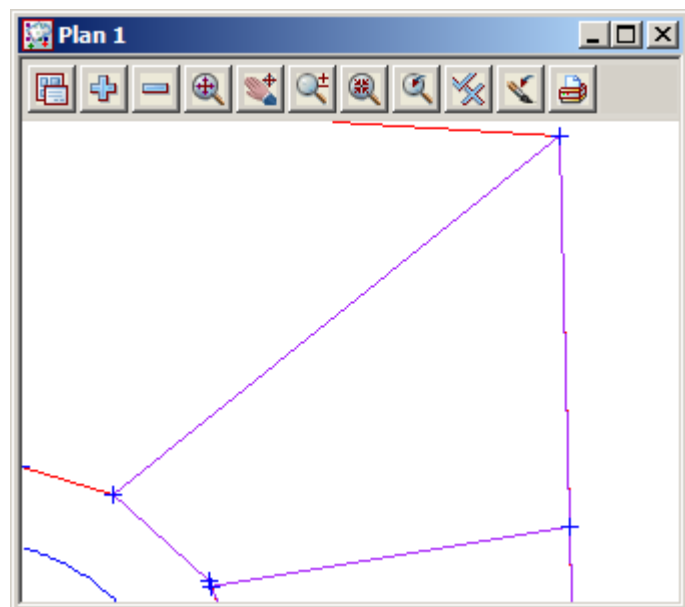

To inquire on the area select *Strings=>Inquire*
or **String Inquire** icon

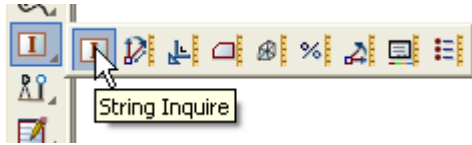

Select anywhere on the lot edge but do not confirm

If the lot polygon is highlighted the area is displayed in the **Information panel**

Press **Escape** key to exit the Inquire option

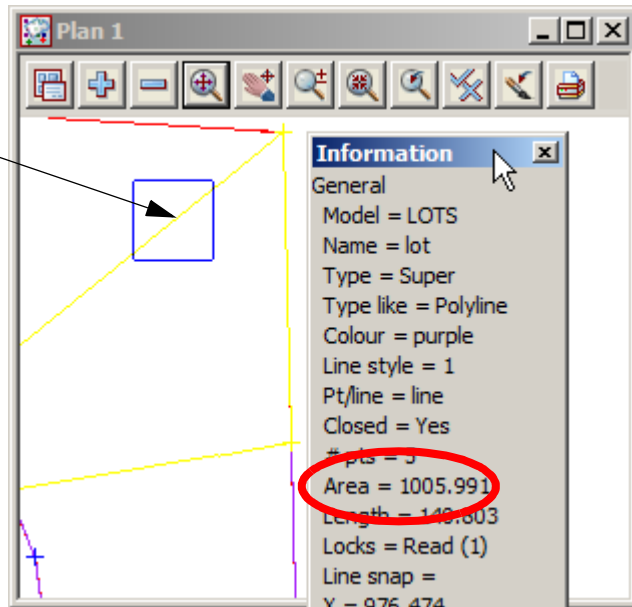

The next lots will be created using the minimum area panel again
Pan left from the last created lot

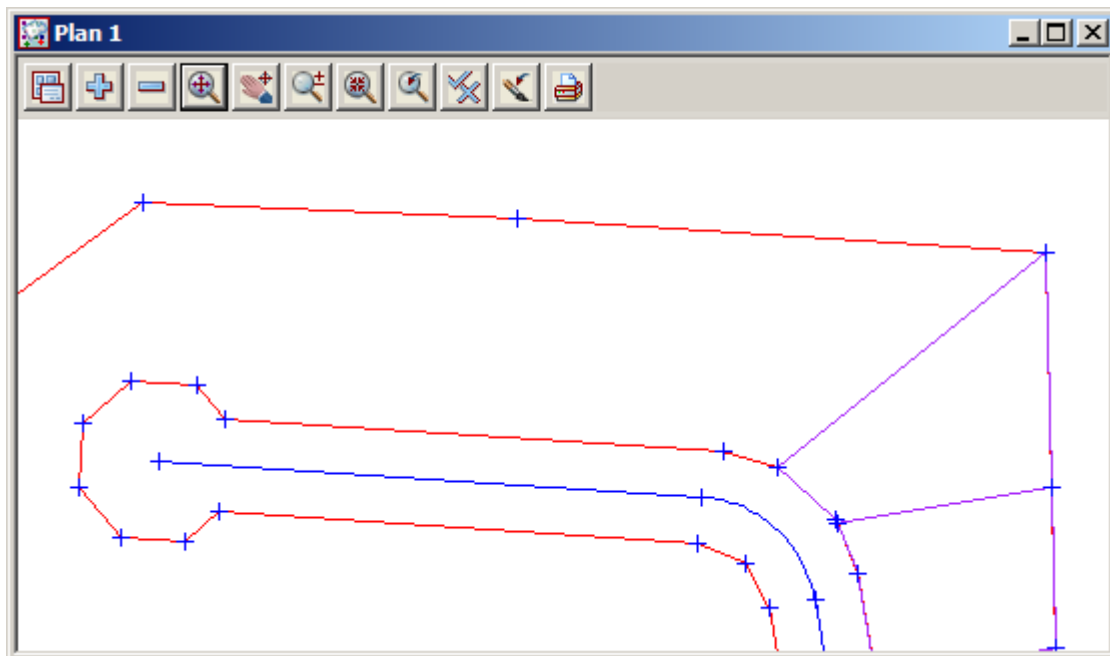

Maximise the **Create Lot** panel

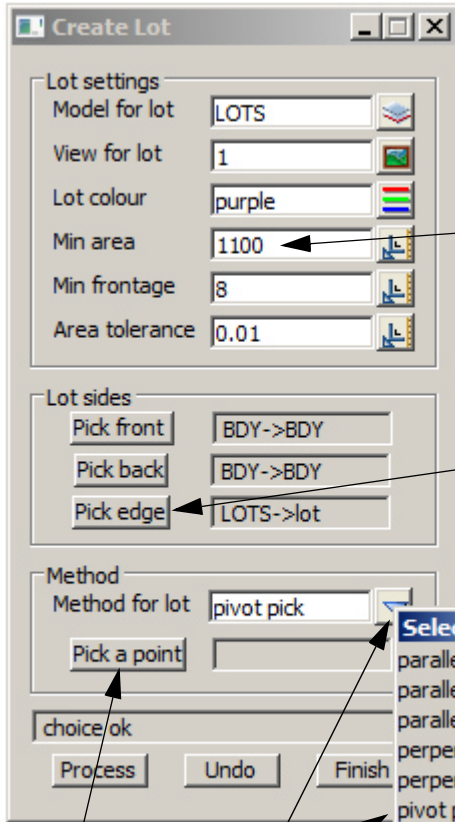

Change the **Min area** to **1100**

Select **Pick edge** then select and accept the last side boundary line

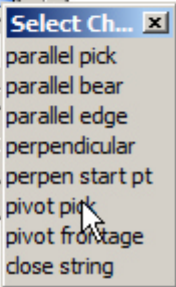

Select **Method for lot** choice icon then select **pivot pick**

Select **Pick a point** then select and accept the next vertex

Select **Process**

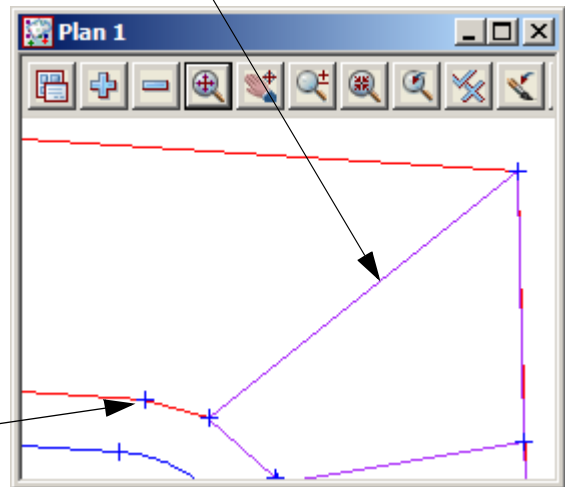

The new lot is created with the new edge pivoting about the selected vertex

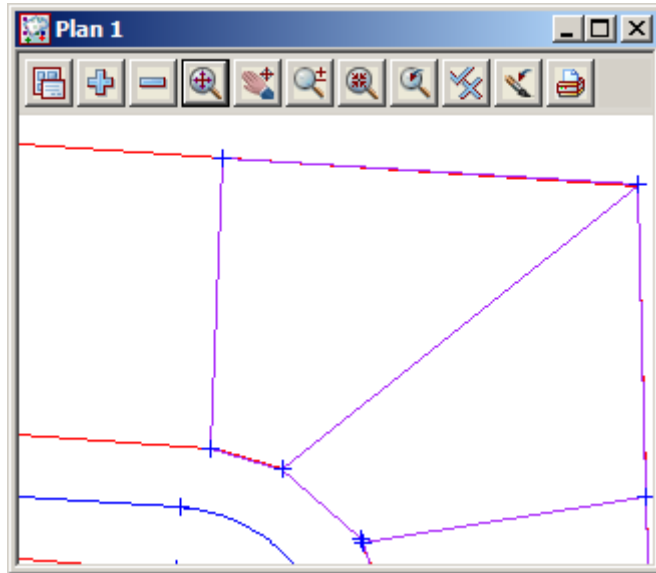

Now change the minimum area back to 800

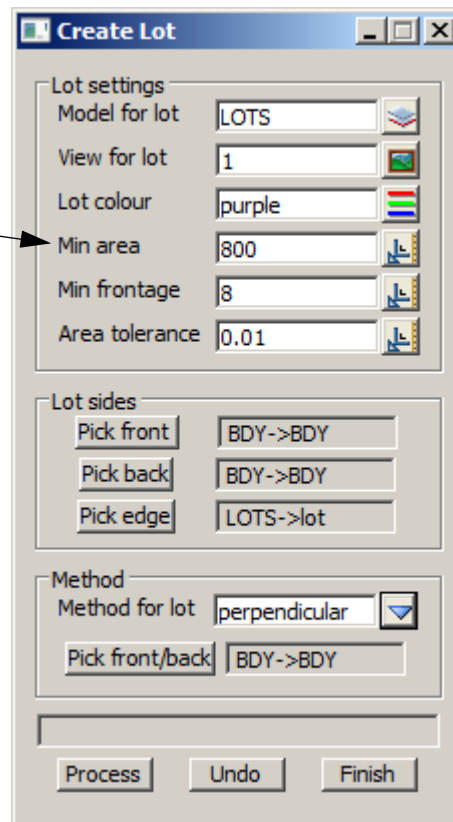

Set the **Method for lot** to **perpendicular**

Select **Pick front/back**

Select and accept the front boundary line

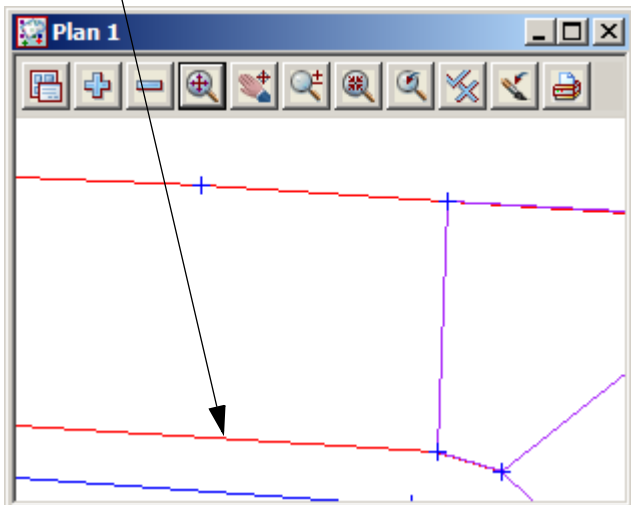

Select **Process** to create the lot

Now change the **Method for lot** to **parallel pick**

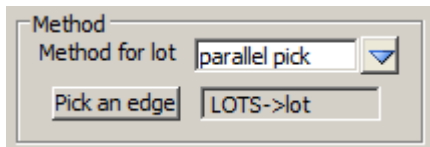

Select **Pick an edge** and select the previously created lot edge

Select **Process** again twice

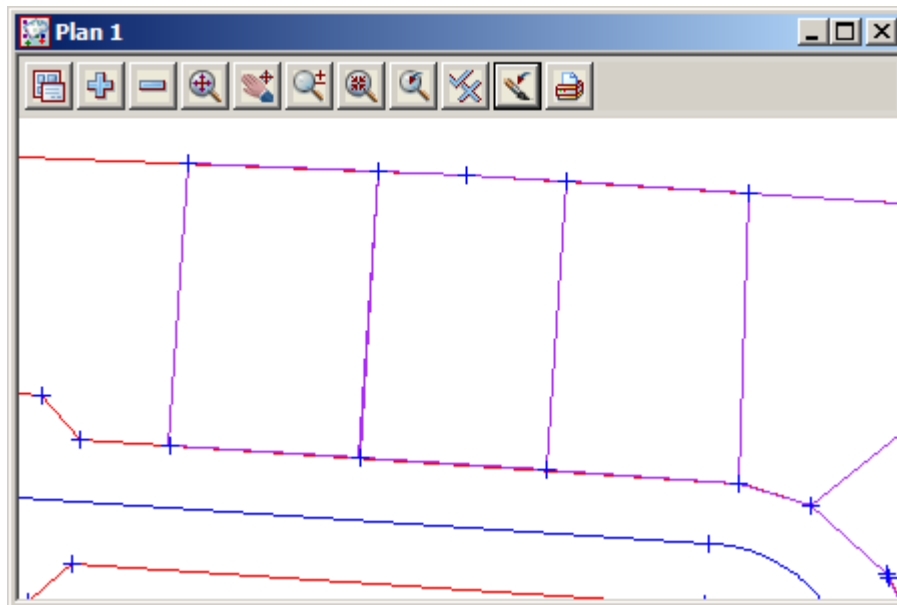

Zoom in to the end of the cul de sac

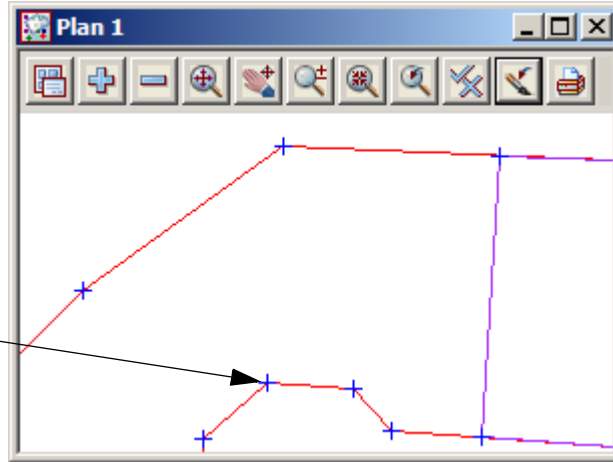

The next lot will be created with area of **900** and the new boundary edge to pivot from this vertex

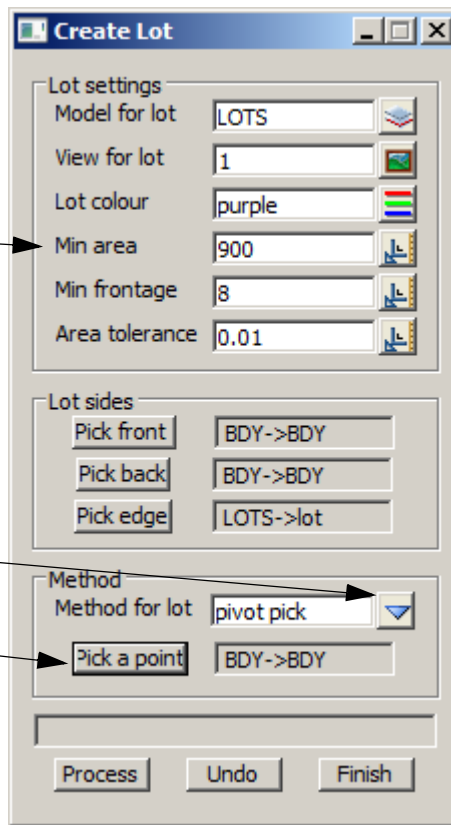

Change the minimum area to **900**

Set the **Method for lot** to **pivot pick**

Select **Pick a point**

Select and accept the pivot point

Select **Process** then **Finish**

A new lot is created

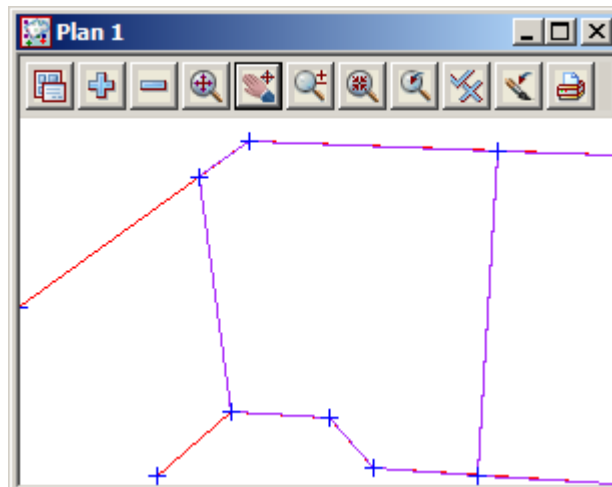

Pan around to the bottom of the cul de sac

The next lot will be a park lot.

We will use the option to create lot by selecting the sides.

The final edge will lie between these vertices

Minimise the **Create Lot** panel again

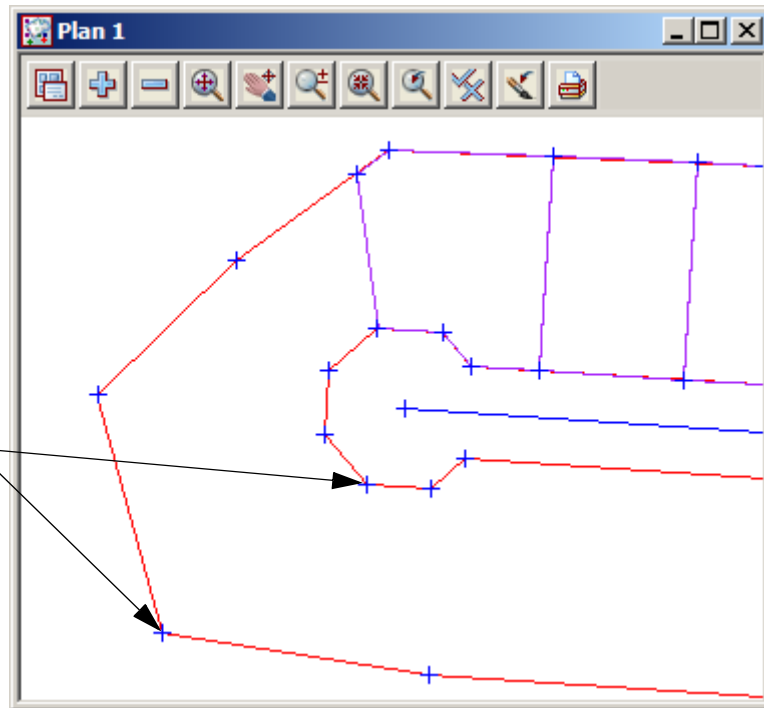

Select option *Design=>Estate/Lots=>Create lots=>Create lots by picking segments*

Select model **PARK**

Select colour **green**

Tick the check box to **Join first and last segment**

Select **Pick sides**

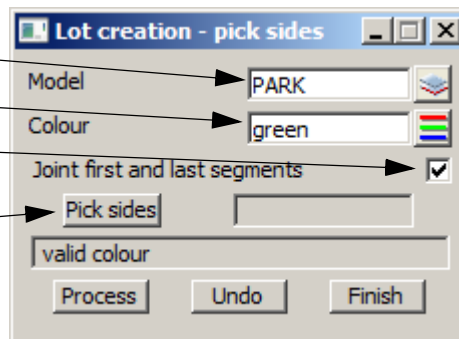

Select and accept the sides with direction in a clockwise direction from this vertex

After accepting last line select **Process** then **Finish**

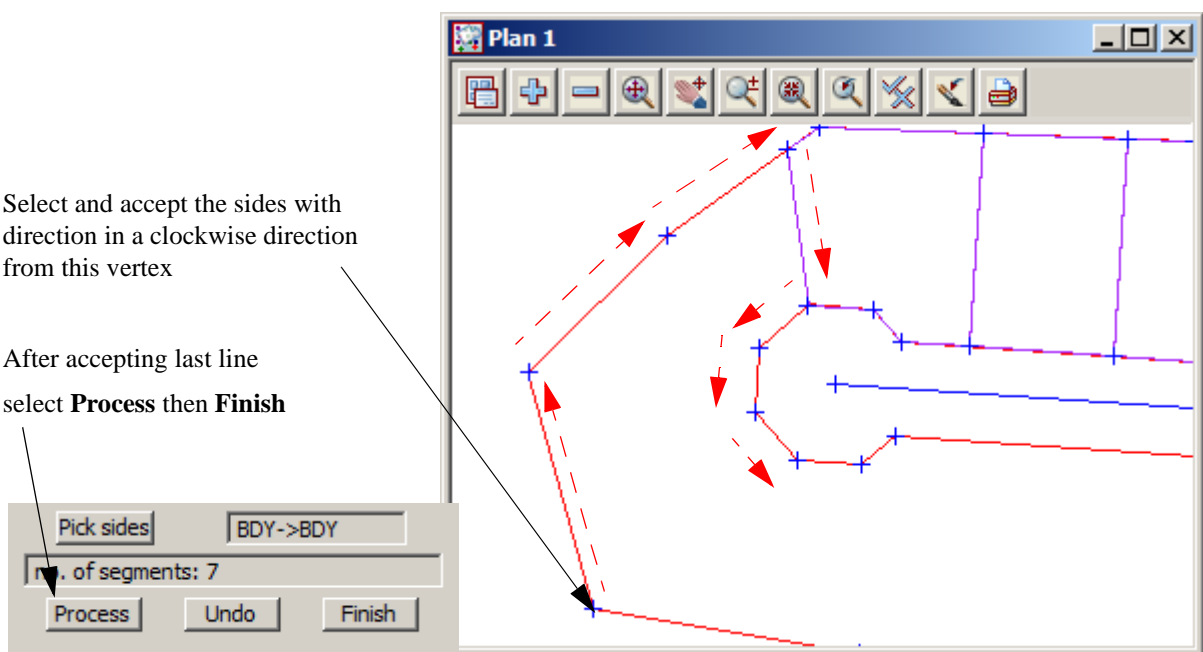

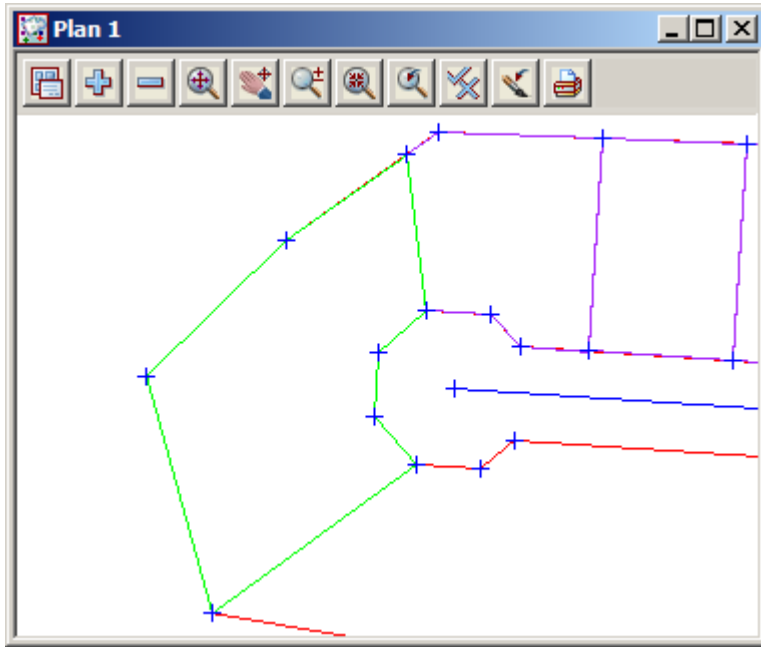

For the next six lots we will use the previous **Create lots** option

Pan along the right as per the example below

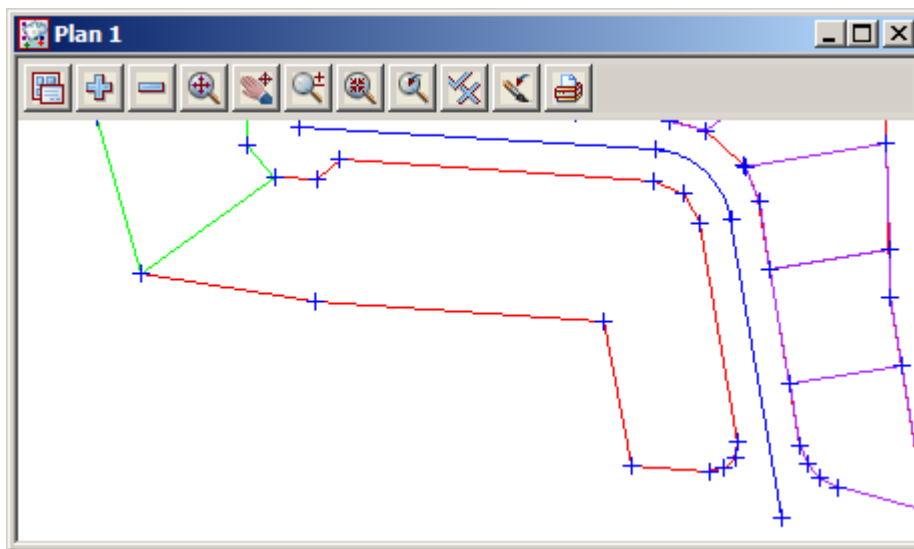

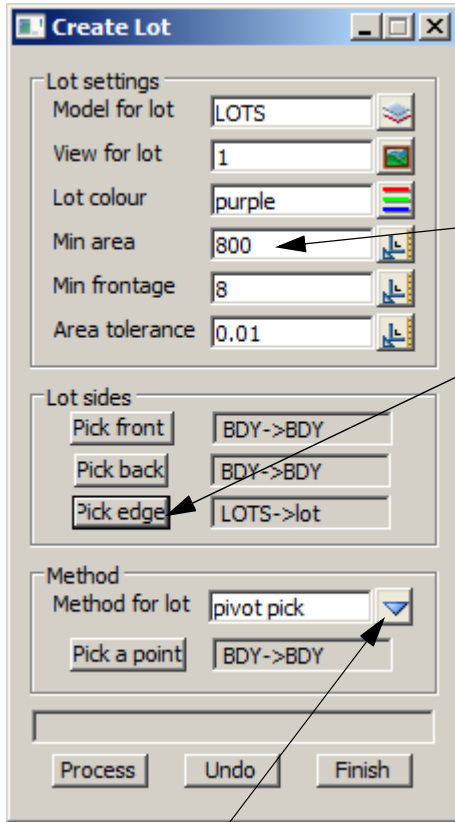

Type in **800** as minimum area

Select **Pick edge** then select and accept the front boundary line

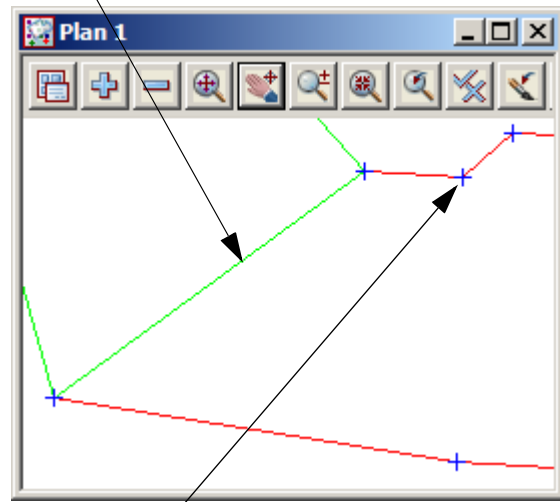

Select **Method for lot** icon then select **pivot pick**

Select and accept point at next vertex

Select **Process**

The new lot is created

For the next three lots we change the **Method for lot** to **parallel bearing**

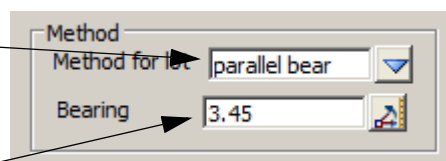

Type in the bearing **3.45**

Select **Process** three times

The three new lots are created with the new side at bearing $3^{\circ}45'$

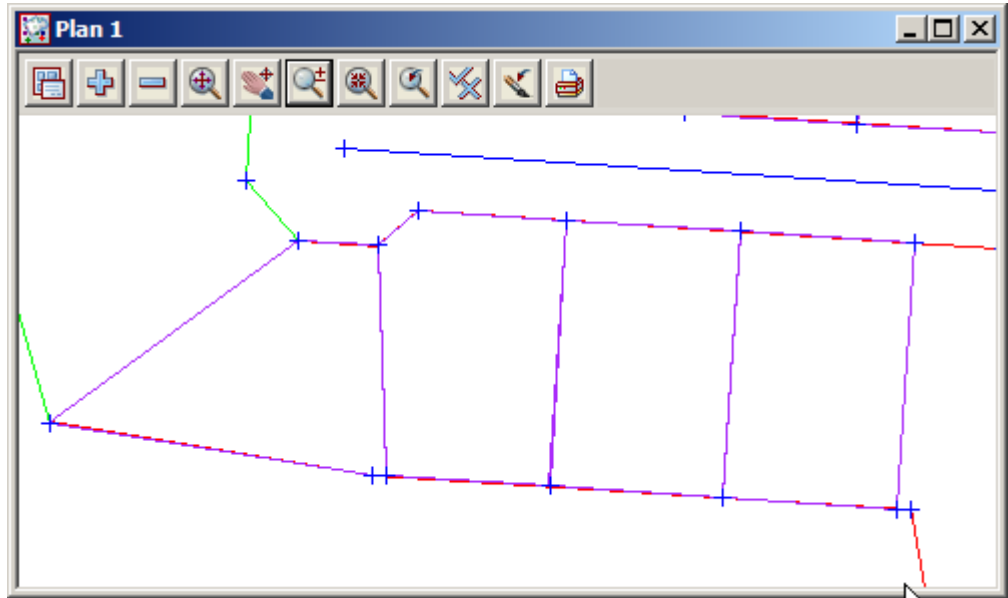

Pan down to the last section of the subdivision

The next lot will have its new edge pivot from a rear vertex

Change **Method** for lot to **pivot pick**

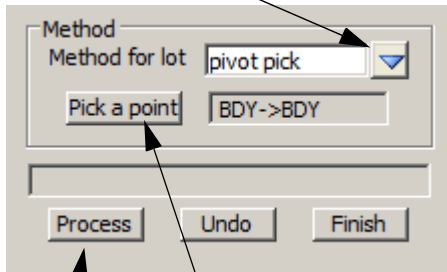

Select **Pick a point** then select and accept the next vertex on the rear boundary

Select **Process** to create new lot

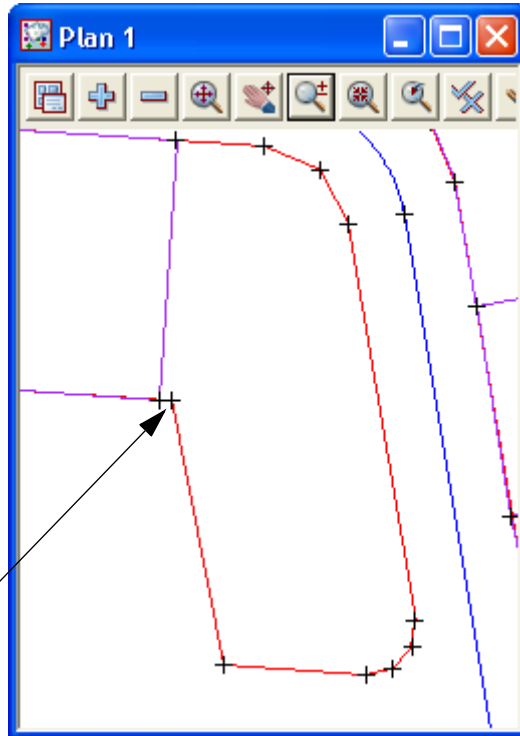

The new lot is created

Select **Finish** on **Create Lot** panel

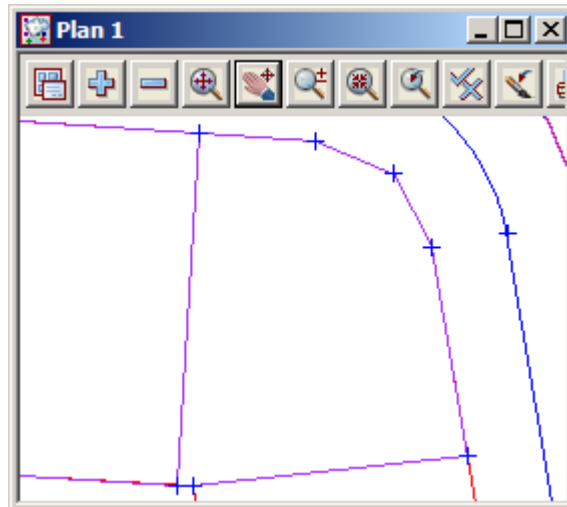

To create the last lot we will use an option to form a lot polygon from picking the centre of a series of strings. A search distance is entered to find all strings within the search distance radius

Pan down to the last lot

Select *Design=>Estate/lots=>Create lots=>Create lots by picking point inside*

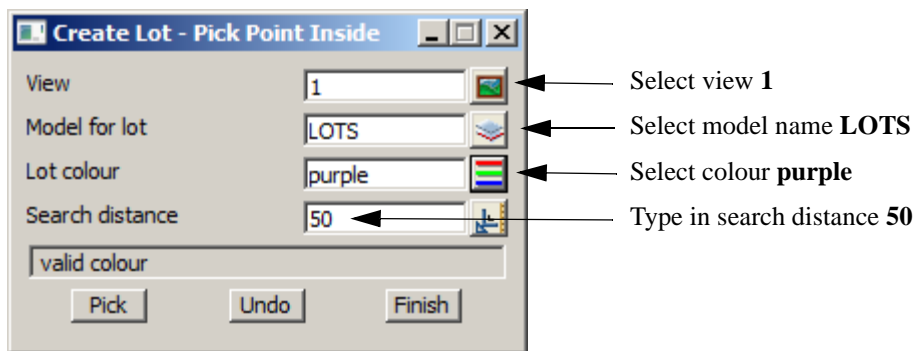

Select **Pick** and select and accept a point inside the area to create the lot. Ensure the position you pick can see to each vertex of the lot

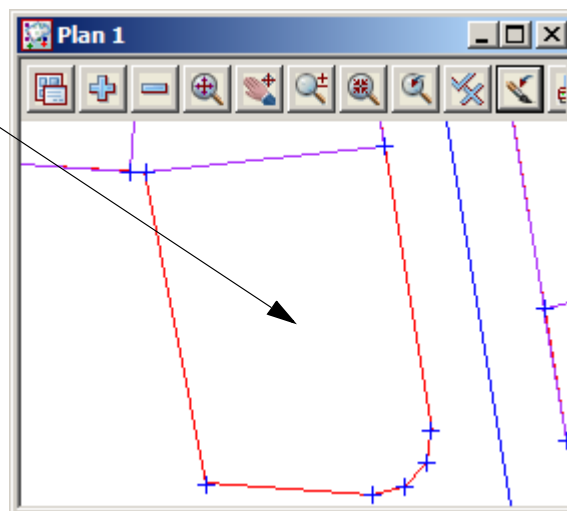

The new lot is created

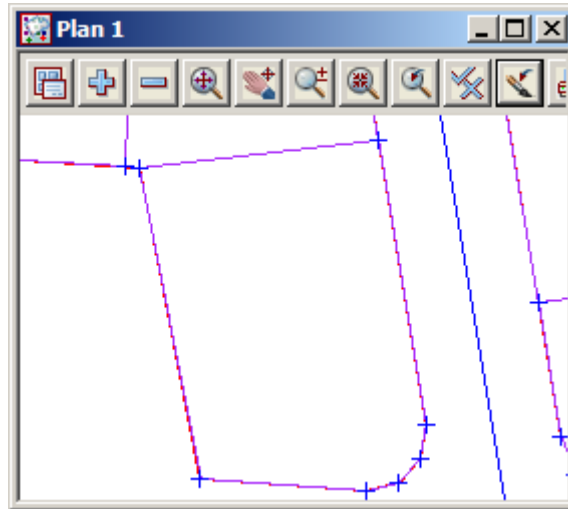

- This completes the house lots
- We now create a lot for the road.
- Zoom the whole of the subdivision
- Turn off models **LOTS** and **PARK** and **CENTRELINE**
- Turn on the model **SURROUND** mode
- Turn off the vertices

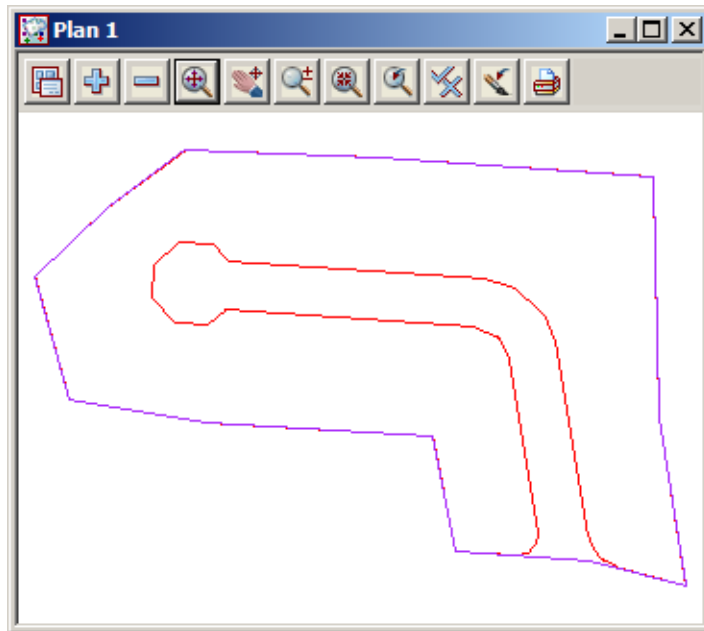

Set the cad control parameters as shown below

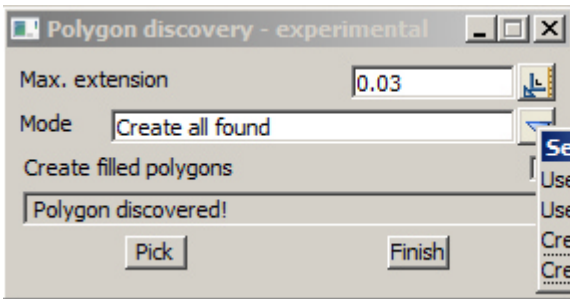

To create a polygon bound by the boundaries and the surround edge select *Design=>Estate/lots=>Create lots=>Create lots from picking points inside (experimental)*

- Select the Mode icon
- Select **Create all found**



Tick check box to create a solid fill of the polygon

Select **Pick** then pick inside the road area

A polygon is created in the ROAD model

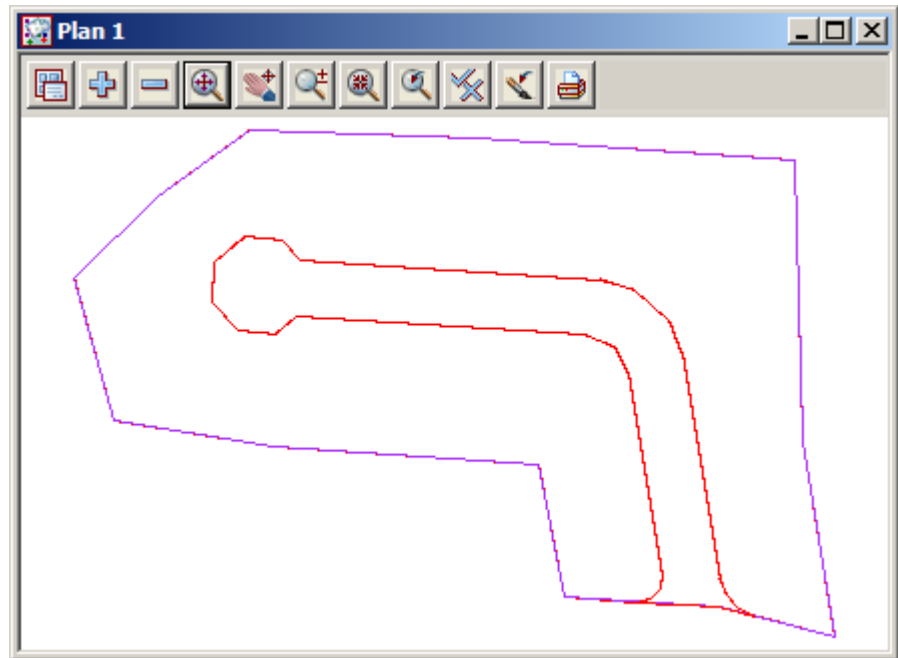

12.8 Lot numbering

The lots can now be numbered according to the type of lot.

Lots, parks and roads will be numbered separately

Zoom all of the subdivision and ensure that only models **LOTS**, **PARK** and **ROAD** are turned on

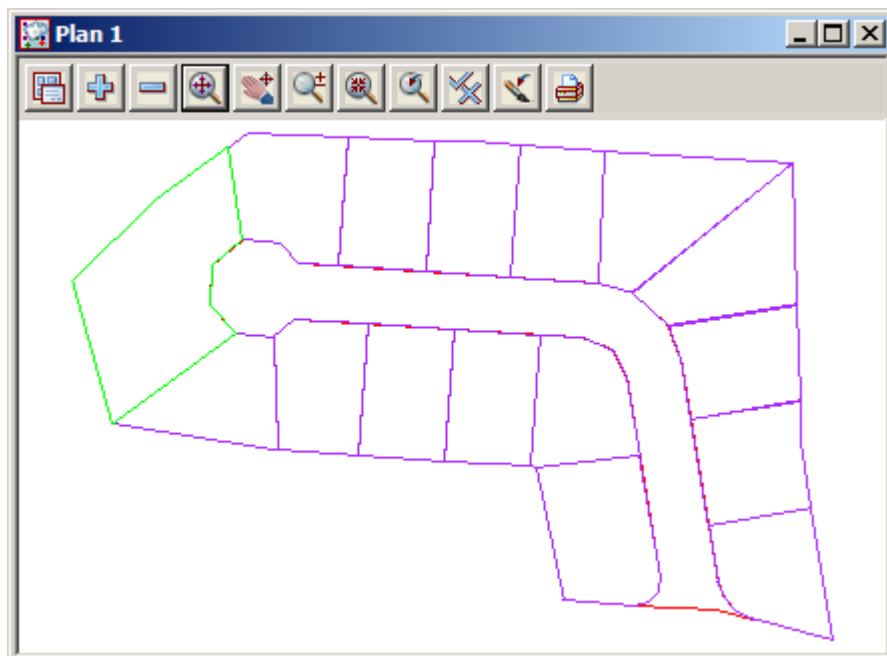

12.8.1 Create lot numbers

Select option *Design=>Estate/Lots=>Number Lots=>Create lot numbers*

The 'Create Lot Number' dialog box contains the following fields and options:

- Data source:** view (dropdown)
- Lot view:** 1 (dropdown)
- Next lot no.:** 1 (text input)
- Lot type:** lot (dropdown)
- New lot colour:** purple (color picker)
- Auto increment:** (checkbox)
- Lot increment:** 1 (text input)
- Display lot number:** (checkbox)

Buttons: Pick, Undo, Finish

Annotations for the dialog box:

- Select the **Data source** icon then select **view**
- Select **view 1**
- Type in **1** for **Next lot no.**
- Select **Lot type** choice icon
- Select **lot**
- Select colour **purple**
- Tick **Auto increment** check box
- Type in **1** as **Lot increment**
- Tick **Display lot number** check box

Annotations for the 'Plan 1' window:

- Select **Pick**
- Select and accept a segment of the first lot

The 'Plan 1' window displays a site plan with 15 numbered lots. The lots are arranged in a grid-like pattern with a central road. The numbering starts from the bottom right (lot 1) and proceeds in a sequence towards the top left (lot 9), then continues from the bottom left (lot 10) towards the top right (lot 15).

Annotations:

- Repeat numbering lots until reaching the park
- Continue numbering the lots from the other side of the park

To create the description for the park change the following settings

The 'Create Lot Number' dialog box is shown with the following settings: Data source: view; Lot view: 1; Next lot no.: PARK; Lot type: park; New lot colour: green; Auto increment: checked; Lot increment: 1; Display lot number: checked. The 'Pick' button is highlighted. Arrows point from the 'Next lot no.' field to the text 'Type in PARK as Next lot number', from the 'Lot type' dropdown to 'Select Lot type choice icon and select park', and from the 'New lot colour' dropdown to 'Change the colour to green'. The 'Plan 1' window shows a subdivision plan with a green lot labeled 'PARK'. An arrow points from the 'PARK' label in the plan to the text 'Pick and accept the park string'.

Select **Pick**

Pick and accept the park string

Type in **PARK** as Next lot number

Select **Lot type** choice icon and select **park**

Change the colour to **green**

To number the road change the following settings

The 'Create Lot Number' dialog box is shown with the following settings: Data source: view; Lot view: 1; Next lot no.: ROAD; Lot type: road; New lot colour: red; Auto increment: checked; Lot increment: 1; Display lot number: checked. The 'Pick' button is highlighted. Arrows point from the 'Next lot no.' field to the text 'Type in ROAD as Next lot number', from the 'Lot type' dropdown to 'Select Lot type choice icon and select road', and from the 'New lot colour' dropdown to 'Change the colour to red'. The 'Plan 1' window shows a subdivision plan with a red lot labeled 'ROAD'. An arrow points from the 'ROAD' label in the plan to the text 'Pick and accept the road string'.

Select **Pick**

Pick and accept the road string

Select **Finish** to exit the panel. The temporary numbers will disappear

Type in **ROAD** as Next lot number

Select **Lot type** choice icon and select **road**

Change the colour to **red**

12.9 Lot labelling

The lot annotation can now be created. Features such as bearings, distances, lot numbers and areas are created for each lot

The annotation settings can be stored in a Lot annotation file which is loaded prior to creating the annotation

Ensure that the models **LOTS**, **PARK** and **ROAD** are the only models active

Zoom all of the subdivision

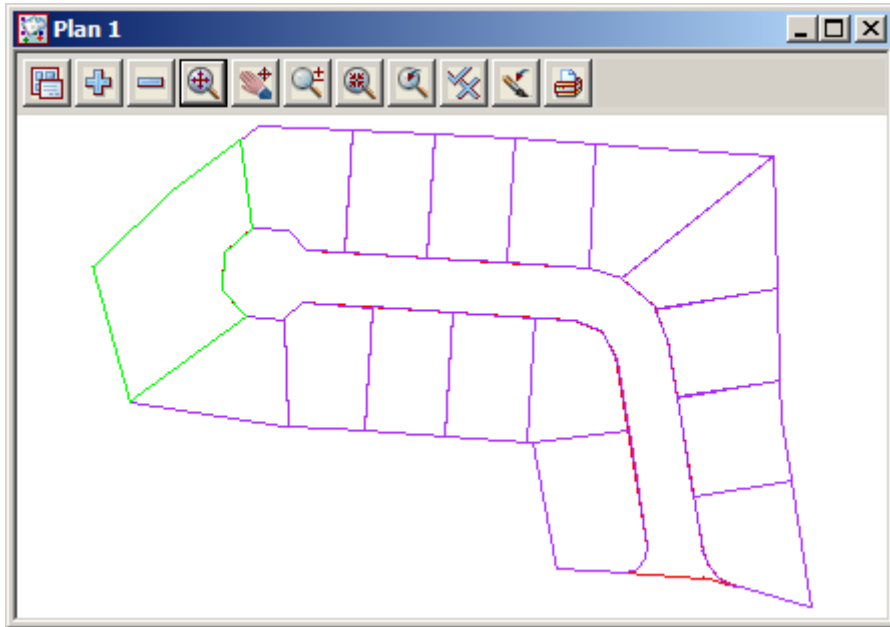

Select option *Design=>Estate/Lots=>Label Lots=>Lot labelling*

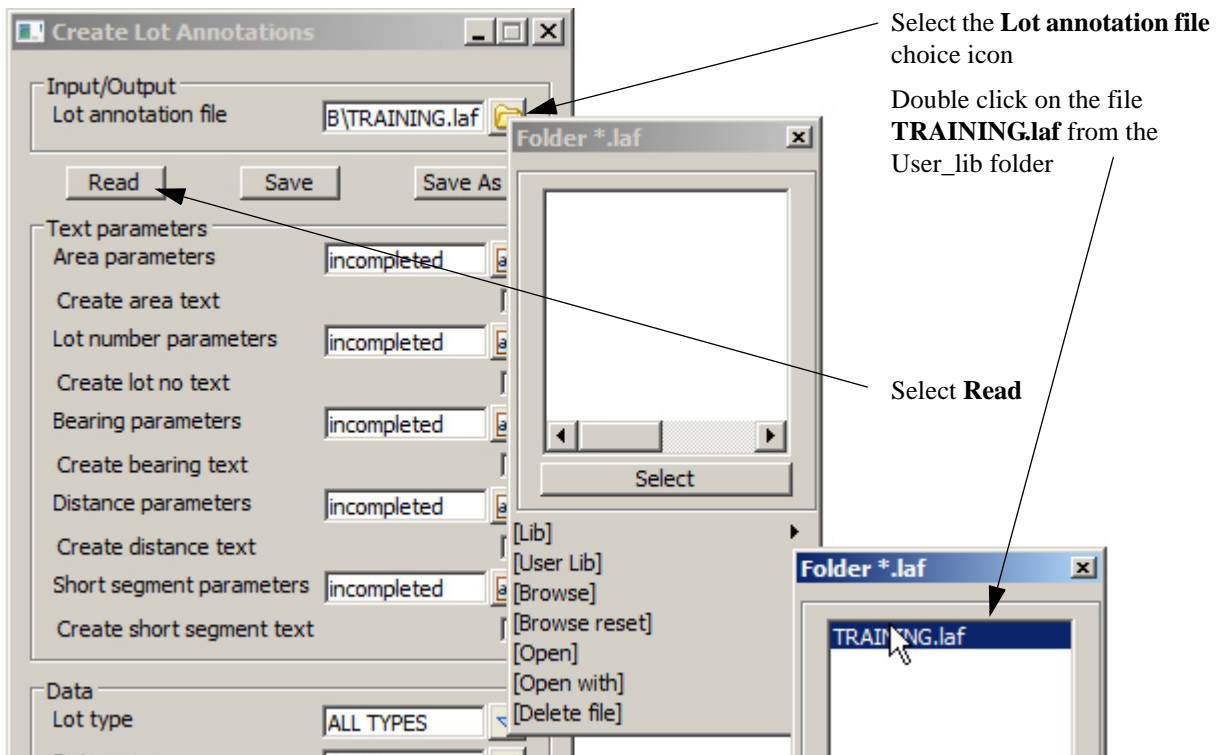

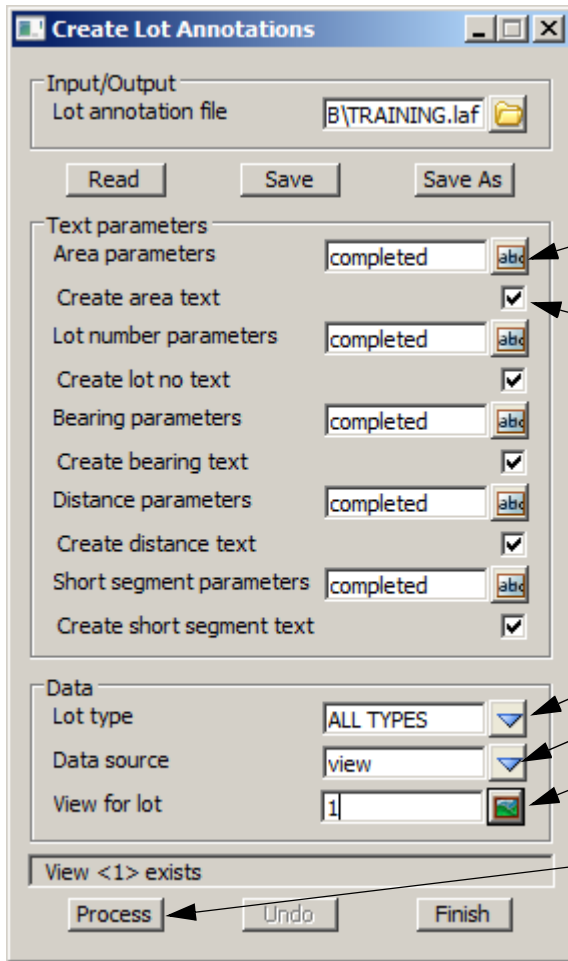

Each type of annotation can be edited by selecting the edit icon

To create the different text types tick the relevant check boxes

A short line table can be created which will tabulate any line where the distance of the line is less than a user defined value

Select **Lot type** choice icon and select **ALL TYPES**

Select **Data source** icon and select **view**

Select **view 1**

Select **Process**

Turn on the annotation models

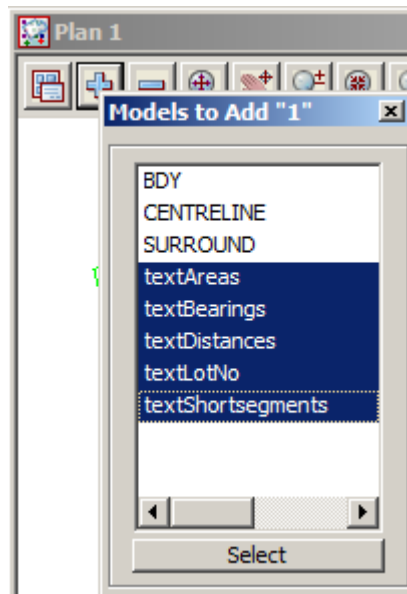

Set the plot scale to 1:500

Select **Menu** icon

Walk right on
Settings=>Plotting scale

Select view **1**

Type in scale **500**

Select **Set** then

Finish

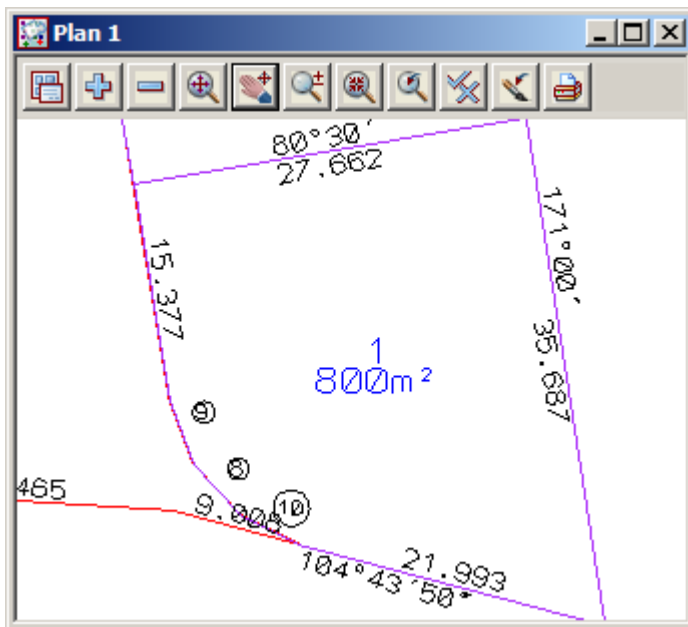
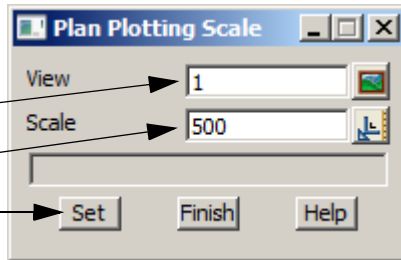

12.9.1 Edit the annotation

The annotation text can now be edited by using options on the text flyout toolbar



Reverse Bearing

To reverse the direction of a bearing label select option *Design=>Estate/Lots=>Lot Utilities=>Reverse Bearing*

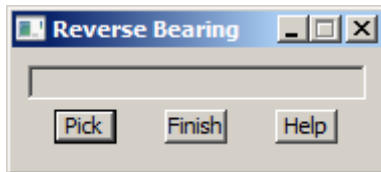

Select and accept the bearing to be reversed. You may need to turn on the vertices to see the insertion point of the text or you can turn on the text snap [X] from the snaps toolbar to click anywhere in the text

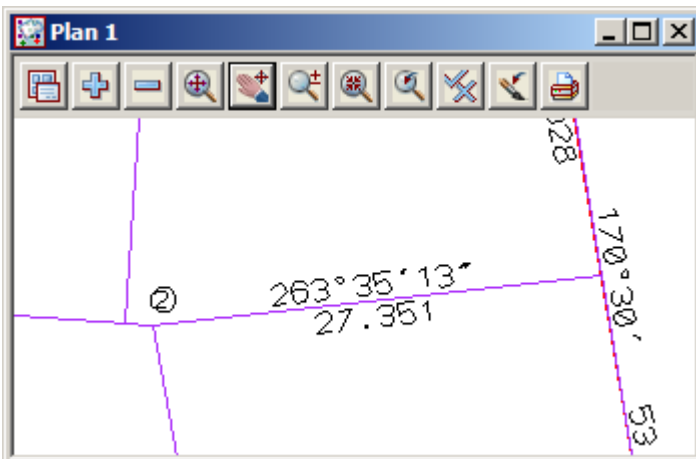
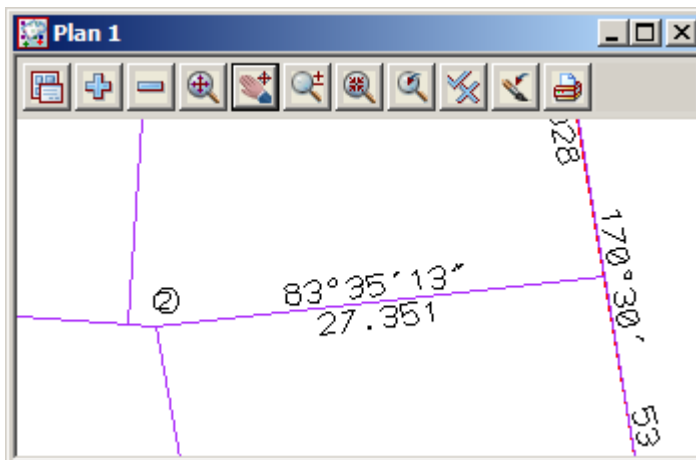
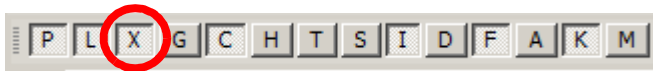

12.9.2 Create Short Line table

The short lines have been identified with a circled number

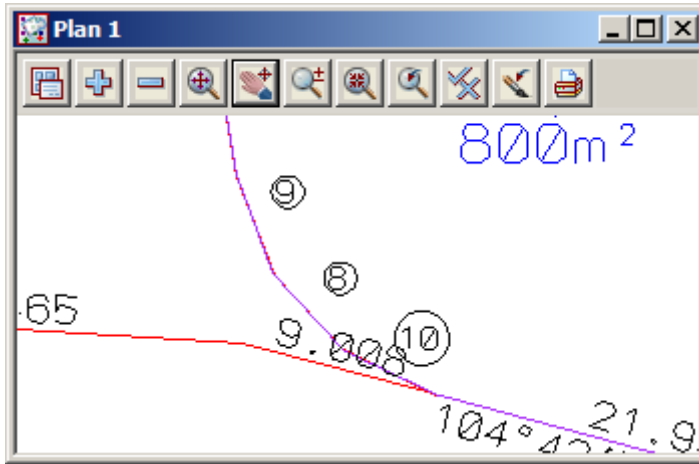

We now need to create the short line table

Select option *Design=>Estate/Lots=>Lot Utilities=>Short line/arc table*

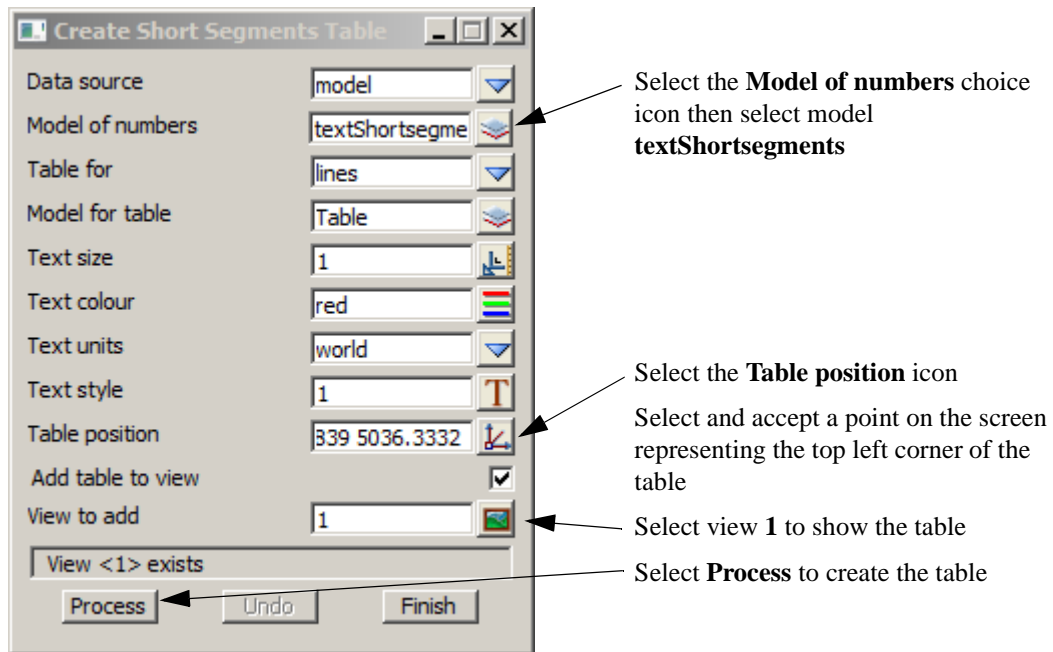

The bearing and distances of the short lines are displayed along with the relevant lot number

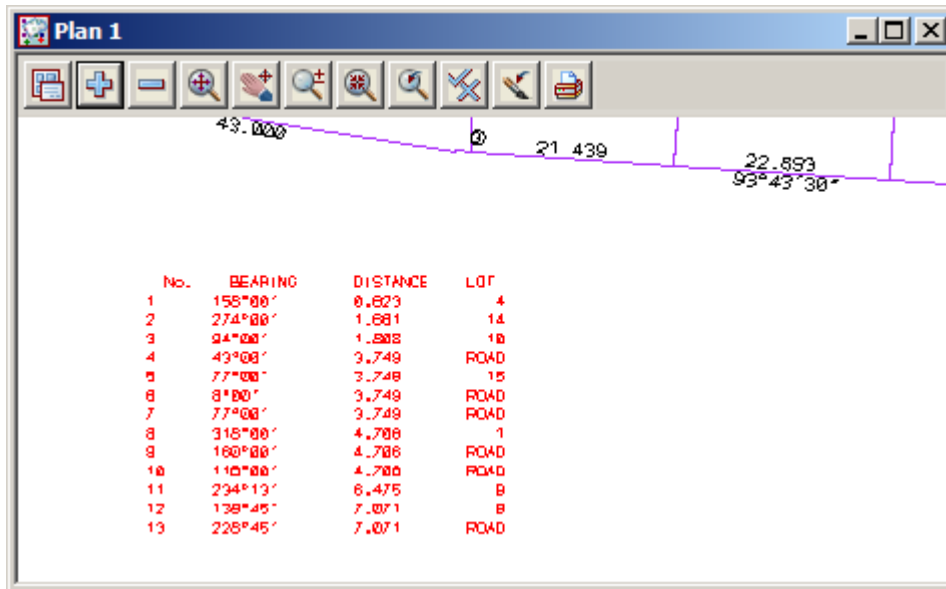

To move the table select option *Drafting=>Multi strings translate*

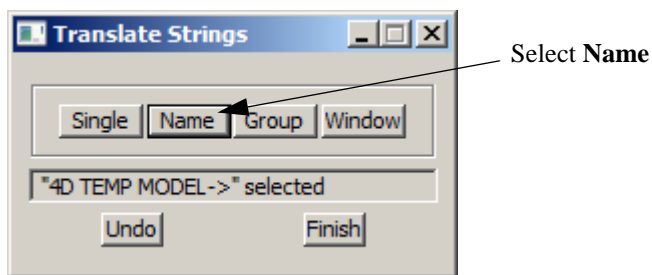

Select and accept a piece of text in the table

Move the table to a new location and accept the position

Select **Finish** to exit the option

12.10 Create colour table of lot areas

Lots can be coloured and a table created based on the size of the lot.

Select option *Design=>Estate/Lots=>Lot Utilities=>Colour lots by range file*

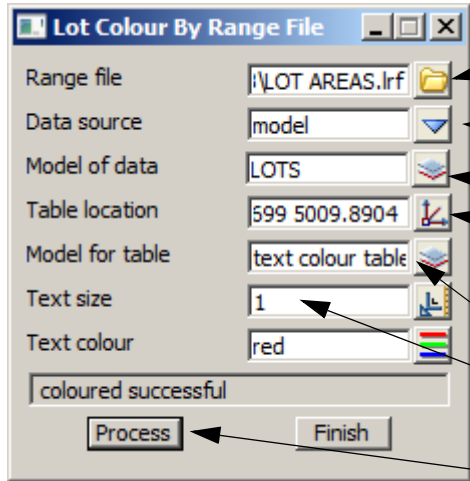

The screenshot shows the 'Lot Colour By Range File' dialog box with the following settings and annotations:

- Range file:** i:\LOT AREAS.lrf (Annotation: Select **Range file** icon. Select range file **LOT AREA.lrf** from the User_lib folder.)
- Data source:** model (Annotation: Set the **Data source** to **model**)
- Model of data:** LOTS (Annotation: Select **LOTS** as the **Model of lots**)
- Table location:** 599 5009.8904 (Annotation: Select the **Table location** icon and select **Pick xyz**)
- Model for table:** text colour table (Annotation: Select and accept a point on the screen representing the top left corner of the table)
- Text size:** 1 (Annotation: Type in **1** as the text size)
- Text colour:** red (Annotation: Select **Red** as text colour)
- Buttons:** Process and Finish (Annotation: Select **Process** then **Finish** to colour the lots and create the table)

A status bar at the bottom of the dialog shows 'coloured successful'.

Turn on the model text colour table

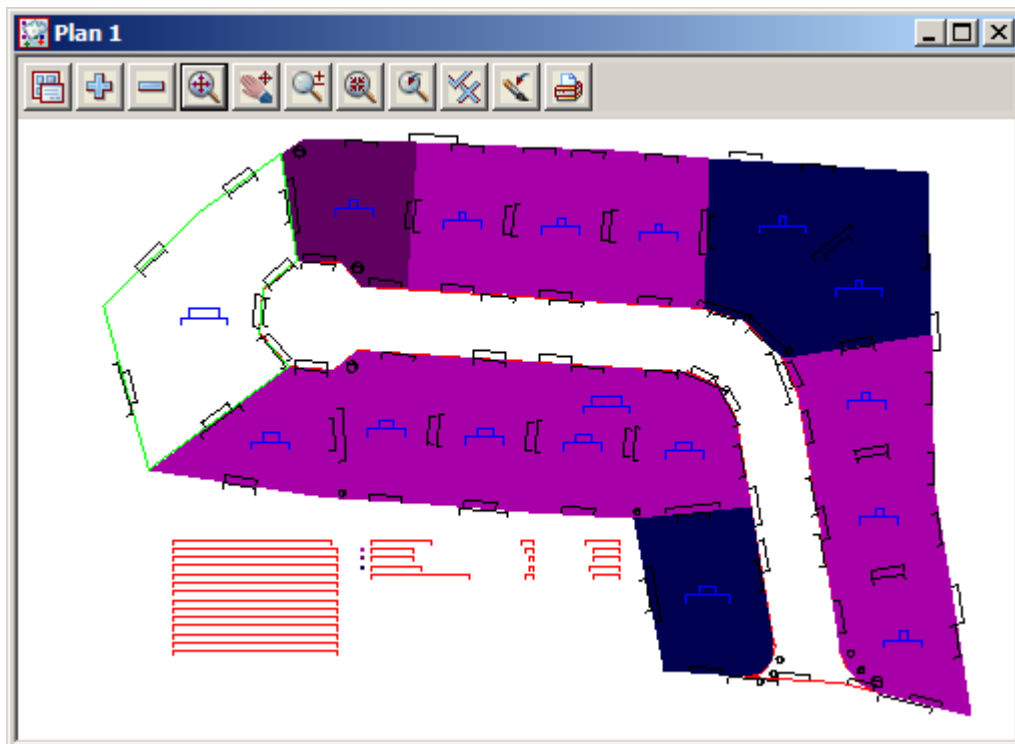

The lots are coloured based on the mapping file

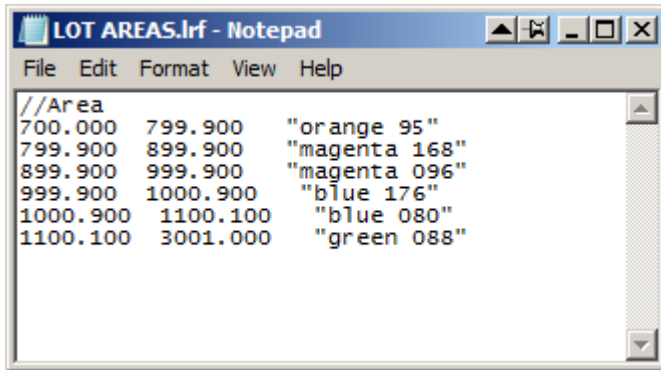

```
//Area
700.000 799.900 "orange 95"
799.900 899.900 "magenta 168"
899.900 999.900 "magenta 096"
999.900 1000.900 "blue 176"
1000.900 1100.100 "blue 080"
1100.100 3001.000 "green 088"
```

Zoom in to the colour table

The lot sizes are listed along with the number of lots in each category and the average area

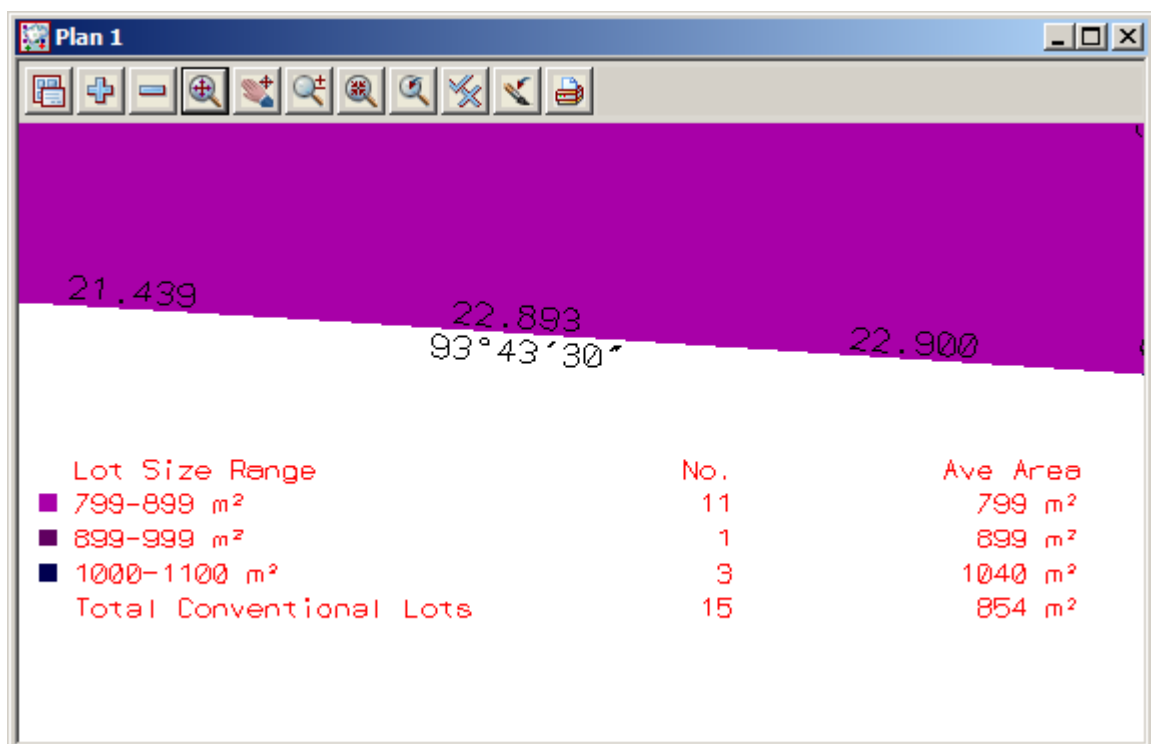

12.11 Lot Reporting

We will now generate a report on the subdivision

Turn on the **SURROUND** models to use as the Boundary

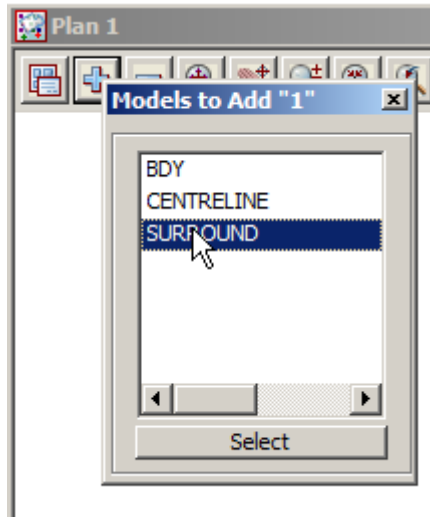

Select option *Design=>Estate/Lots=>Report Lots*

Select **Data source** icon then select **view**

Select **view 1**

Select **Report type** icon then select **sort by type**

Select **Boundary** then select and accept part of the **SURROUND** string

Type in **3** for number of decimal places

Type in **0** for number of decimals for the seconds in the bearing

Type in report file name **LOTS**

Select **Process**

Select **Report file** folder icon

Select **LOTS.rpt**

Select **Open**

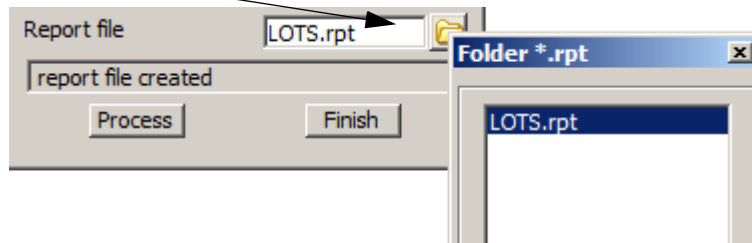

The first section of the report deals with the lots

The number, area and dimensions are displayed along with the vertex co-ordinates

REPORT OF LOTS SORTED BY TYPE						

LOT TYPE: LOT						

Lot Number: 1		Area: 800.007				
Ln	Bearing	Distance	ArcLength	Radius	Eastings	Northings
-----	-----	-----	-----	-----	-----	-----
1	171°00'0"	35.687			994.417	5035.248
2	284°43'50"	21.993			1000.000	5000.000
3	295°41'32"	4.706			978.730	5005.592
4	317°36'55"	4.706			974.490	5007.632
5	339°32'18"	4.706			971.318	5011.108
6	350°30'0"	15.377			969.673	5015.517
7	80°30'0"	27.662			967.135	5030.683
Lot Number: 2		Area: 800.008				
Ln	Bearing	Distance	ArcLength	Radius	Eastings	Northings
-----	-----	-----	-----	-----	-----	-----
1	170°30'0"	28.478			962.435	5058.770
2	80°30'0"	27.662			967.135	5030.683
3	351°00'0"	16.984			994.417	5035.248
4	358°30'0"	11.608			991.761	5052.023
5	260°30'0"	29.425			991.457	5063.627
Lot Number: 3		Area: 800.001				
Ln	Bearing	Distance	ArcLength	Radius	Eastings	Northings
-----	-----	-----	-----	-----	-----	-----
1	157°42'30"	8.704			956.347	5083.477
2	170°30'0"	16.885			959.648	5075.423
3	80°30'0"	29.425			962.435	5058.770
4	358°30'0"	25.622			991.457	5063.627
5	260°30'0"	34.918			990.786	5089.240

After the last lot is displayed, the number of lots along with the total area, average area and percentage of the boundary (SURROUND) are listed

Number of lots:	15
Total area:	12820.958
Average area:	854.731
Percentage of Boundary:	72.581%

The park is listed

LOT TYPE: PARK

Lot Number: PARK Area: 1798.825

Ln	Bearing	Distance	ArcLength	Radius	Eastings	Northings
1	344°32'30"	39.500			808.646	5057.519
2	45°49'0"	31.200			798.118	5095.590
3	54°13'0"	23.525			820.492	5117.335
4	172°05'36"	25.015			839.576	5131.091
5	228°45'0"	10.355			843.017	5106.314
6	183°45'0"	10.355			835.232	5099.486
7	138°45'0"	10.355			834.554	5089.153
8	233°55'34"	40.502			841.382	5081.368

Number of lots: 1
 Total area: 1798.825
 Average area: 1798.825
 Percentage of Boundary: 10.183%

The road is listed

LOT TYPE: ROAD

Lot Number: ROAD Area: 3044.466

Ln	Bearing	Distance	ArcLength	Radius	Eastings	Northings
1	228°45'0"	7.071			857.032	5085.353
2	273°45'0"	10.355			851.715	5080.690
3	318°45'0"	10.355			841.382	5081.368
4	3°45'0"	10.355			834.554	5089.153
5	48°45'0"	10.355			835.232	5099.486
6	93°45'0"	10.355			843.017	5106.314
7	138°45'0"	7.071			853.350	5105.637
8	93°45'0"	80.067			858.013	5100.321
9	106°32'30"	9.326			937.909	5095.084
10	132°07'30"	12.487			946.849	5092.429
11	157°42'30"	9.326			956.110	5084.053
12	170°30'0"	60.740			959.648	5075.423
13	159°32'18"	4.706			969.673	5015.517
14	137°36'55"	4.706			971.318	5011.108
15	115°41'32"	4.706			974.490	5007.632
16	284°43'50"	9.008			978.730	5005.592
17	273°44'10"	22.465			970.019	5007.882
18	76°31'48"	3.749			947.601	5009.346
19	42°07'5"	3.749			951.247	5010.220
20	7°42'22"	3.749			953.761	5013.000
21	350°30'0"	53.932			954.264	5016.715
22	331°18'45"	8.217			945.363	5069.907
23	292°56'15"	8.217			941.418	5077.115
24	273°45'0"	76.985			933.852	5080.318

Number of lots: 1
 Total area: 3044.466
 Average area: 3044.466
 Percentage of Boundary: 17.235%

At the end of the report the total number of lots are listed along with the area
Any errors in the lot creations should yield a percentage difference to the boundary

```
REPORT OF LOT TYPES SUMMARY
-----
Total number of lots:      17
Grand total area:        17664.248
Percentage of Boundary:   100.000%
-----
Boundary:                 17664.248
Difference:                -0.000
Percentage of Difference: -0.000%
END OF REPORT
-----
```

Exit the report file

